

# Panasonic

ideas for life

PT-D10000E  
3-chip DLP™ Projector

World's smallest\* DLP™ system projector  
with 10,000 lumens of brightness.

\*As of December, 2006



10,000 lm

**SXGA+**  
**AUTO CLEANING ROBOT**



**PT-D10000E**



Projection  
of bright,  
high-quality  
images in large  
spaces.



Classrooms



Conference rooms



Theatres

**High brightness —  
10,000-lumen**

**High contrast ratio —  
5,000:1**

**High image quality — SXGA+**

### Outstanding 10,000-lumen brightness and superb image quality

Thanks to Panasonic's four lamp system, the new PT-D10000E delivers 10,000 lumens of brightness. And with Panasonic's dynamic iris technology, it achieves a super-high 5000:1 contrast ratio. Also featuring 3-chip DLP™ technology that provides high resistance to deterioration due to aging, the PT-D10000E is a durable and reliable performer.

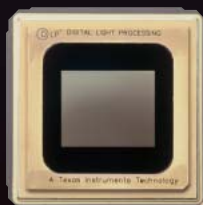

**SXGA+**



# Panasonic's new technologies improve reliability and installation ease

Minimal downtime, high efficiency, and a bright picture.

## MULTI-LAMP OPTICAL SYSTEM

With Panasonic's original four lamp system, the PT-D10000E generates 10,000-lumen brightness. If one lamp burns out during operation, the remaining lamps provide plenty of light to continue projecting. A lamp relay mode is also included. Extended, continuous operation is possible by lamp mode selection.

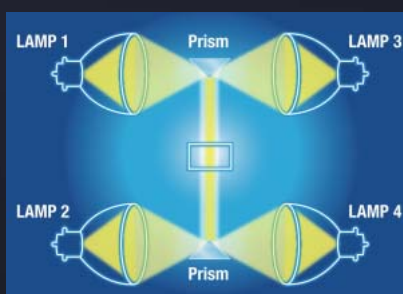

## Lamp replacement cycle and brightness guidelines

Lamp mode	Light output (lumens)	Lamp replacement cycle (hours)
Four lamps	10,000	2,000
Three lamps	7,500	3,000
Two lamps	5,000	4,000
One lamp	2,500	8,000

\*The values above are maximum values when replacing all four lamps simultaneously. The hours may vary depending on the usage conditions. See the back page for details.

Panasonic Original

Provides 2,000 hours of use without filter maintenance.

## AUTO CLEANING ROBOT (ACR)

The PT-D10000E is the world's first\*<sup>1</sup> projector with an automatic filter cleaning system. When you switch on the projector\*<sup>2</sup>, the air filter operates and the brush of the auto cleaning "robot" removes dust from the filter. This prevents the clogging results in malfunctions and other problems.

## AUTO CLEANING ROBOT

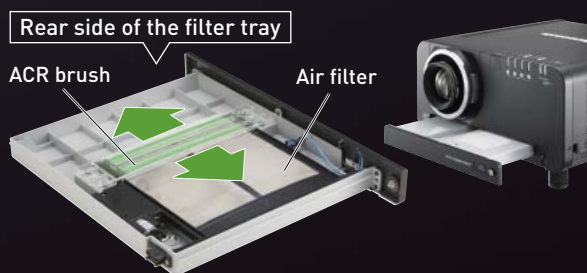

Panasonic Original

## Micro cut filter

A new filter in the air intake section traps dust particles that are 10 microns\*<sup>3</sup> or larger. By capturing approximately 7 times as much dust as our previous filters, it guards against optical blocks and reduces the penetration of dust into to the interior to provide stable operation by, for example, preventing drops in brightness.



\*<sup>1</sup> As of December, 2006. \*<sup>2</sup> When using the timer, you cannot set the filter to be cleaned more than once every 24 hours. Cleaning occurs either when the system is switched on or when it is cooling down when the specified cleaning time comes. The timer can be set to any time between 00:00 and 23:50 in 10-minute increments. You can also manually clean the filter using the menu on the on-screen display. \*<sup>3</sup> Individual lint particles and pollen are examples of dust with a size of 10 microns.

Dramatically reduced the size, weight and volume.

## 1/2 CONCEPT

Panasonic's new liquid-cooling system made it possible to significantly downsize the PT-D10000E, making it one of the most compact in its class. The size is 30% smaller than our previous model\*, and the weight and volume are 70% less than our previous model\*. The PT-D10000E also offers flexible installation and is easy to operate.

\* PT-D9510/PT-D9610

	PT-D9510/PT-D9610	PT-DW10000E
Weight	100 kg	32 kg
Dimensions	W 753 mm x H 428 mm x D 1051 mm	W 578 mm x H 320 mm x D 643 mm
Volume	0.33 m <sup>3</sup>	0.11 m <sup>3</sup>
Power consumption	2,200 W	1,450 W

World's Smallest  
10,000-Lumen DLP™ Projector\*

\*As of December, 2006



# HIGH RELIABILITY

## New cooling structure

Panasonic Original

In order to further enhance the cooling efficiency, we completely revised the placement of various internal components and combined this with our popular cooling system to enable use in temperatures up to 45°C. This allows use in a wider variety of environments, and keeps the operation more stable even in harsh conditions.

## Liquid-cooling system

Panasonic Original

Panasonic's original liquid-cooling system directly cools the DLP™ chips, which extends the PT-D10000E's performance and attains a high level of reliability.

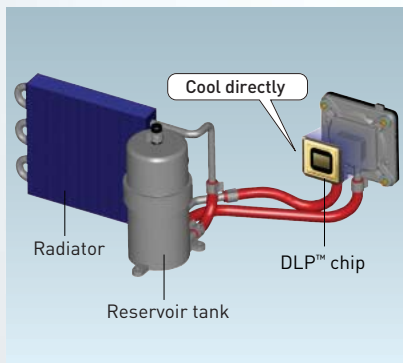

## Web browser control/monitoring and e-mail message alert

Anybody can operate the PT-D10000E by remote control or monitor its status over a LAN network, because it is all done using the computer's familiar web browser. Furthermore, the PT-D10000E sends an e-mail message to notify the operator when an error has occurred, or a lamp needs to be replaced.

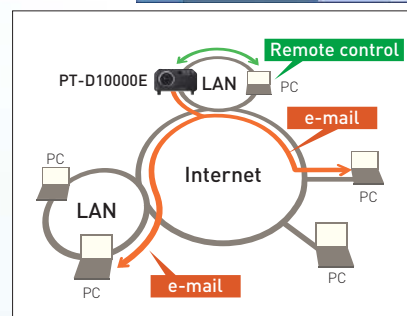
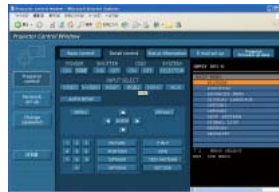

PJLink™

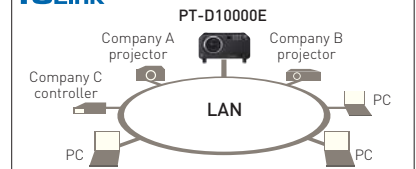

The LAN terminals support PJLink™ class 1 connection. Control with the same specifications is also possible when used in a multi-projector system with projectors of another brand.

## Lamp LED indicator and self-diagnosis function

The projector body is equipped with a temperature alarm LED and a burnt-lamp alarm LED (for lamps 1 to 4). In previous models, the LED indicator was visible only from the front. In the PT-D10000E the LED is visible from both front and top, so you can see it easily even if the unit is hung from the ceiling. Information on the location of the error is also given in the on-screen display. A self-diagnosis function is also provided. Error codes displayed on the 3-digit, 7-segment LED on the side of the projector tell the operator where the problem is.



# HIGH IMAGE QUALITY/FLEXIBLE INSTALLATION

## Dynamic iris

Panasonic Original

Incorporating exclusive Panasonic technology, the dynamic iris opens and closes with exceptional speed and precision as the input signal changes, resulting in accurate, real-time control of the light striking the DLP™ chips. The dynamic iris is positioned immediately after the light synthesiser and before the integrator, so it has minimal adverse effect on the overall light uniformity across the screen.

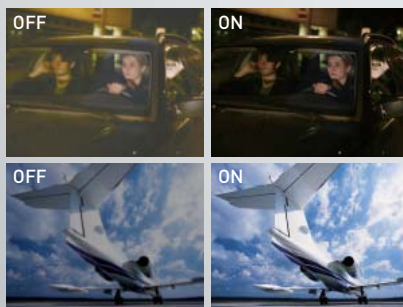

\*Images are simulated.

## Full 10-bit picture processing

The use of a full 10-bit image processing system provides smooth tonal expression. For example, skin tones appear natural and true to life.

## 3D colour management system

Compensation provides optimal levels of colour saturation, hue, and brightness that were not possible with conventional projectors. Colours approach those of the original image, even on large-screen displays.

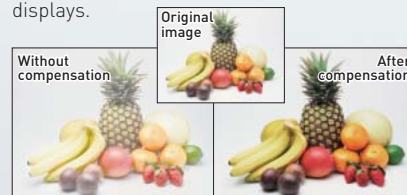

\*Images are simulated.

## Progressive cinema scan (3/2 pulldown)

This interlace/progressive conversion technology automatically detects when the input signal is derived from filmed material and selects the optimum progressive processing method to assure faithful reproduction of the original image.

## Dynamic sharpness control

The dynamic sharpness control circuit adjusts the video signal waveforms based on the difference in brightness of adjacent pixels for a sharp, clear picture that is relatively unaffected by signal noise.

## Horizontal/Vertical lens shift

A wide adjustment range for the horizontal/vertical lens shift assures virtually distortion-free images and adds convenience and versatility. Fine adjustment is made within ±50% from center in the vertical direction and within ±30% from center in the horizontal direction. (Horizontal: powered, Vertical: powered)

\*For the ET-D75LE6, the adjustment is within ±40% in the vertical direction and ±20% in the horizontal direction.

## Optional lenses for various venues

Seven optional lenses with different throw distances are available. These powered zoom/focus lenses enable the projector to perform superbly in an array of projection environments. The lens cover opens in both front and top directions, making it easier to install the lens by viewing the mark on the top of the lens.



# MULTIPLE SYSTEM APPLIANCE

## Built-in multi-screen support system

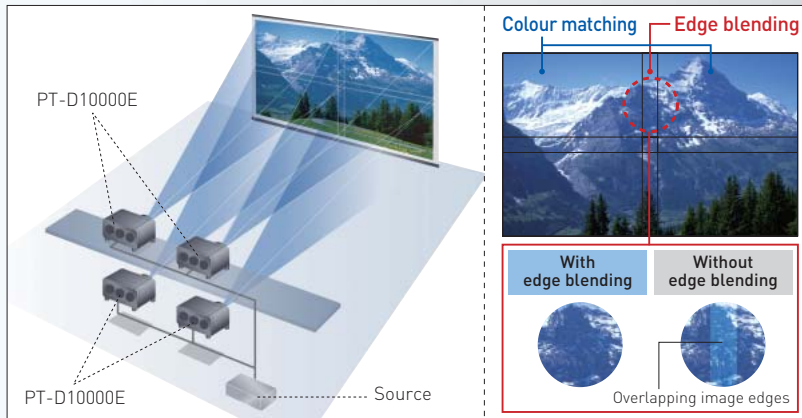

\*When edge blending and colour matching are set, the brightness and colour balance at the boundaries where screens are joined may lack uniformity due to differences in the uniformity of the screen gain directivity, the brightness of each lamp mode, etc.

### Multi-screen processor

The PT-D10000E can project large, multi-screen images without any additional equipment. Up to 100 units (10 x 10) can be edge-blended at a time.

### Colour matching

When several units are used together, this function corrects for slight variations in the colour reproduction range of individual projectors. The PC software assures easy, accurate control. Independent, 7-axis adjustment (red, green, blue, yellow, magenta, cyan, white) ensures high precision and minimises colour variations.

### Edge blending

The edges of adjacent screens can be blended and their luminance controlled. For example, the adjoining edges in a 2x2 multi-screen system can be blended to create a smooth, seamless image.

## Multiple terminals including DVI-D and LAN slots

The PT-D10000E comes equipped with DVI-D and LAN (PJ-Link™) slots. It also features an array of terminals, including two RGB inputs, a 5-BNC connector and D-sub HD 15-pin, serial in/out, S-video input, two remote inputs, and one remote out. In addition to offering DVI-D control, the PT-D10000E is HDCP\*-compliant and thus meets a broad range of projection needs.

\*High-Bandwidth Digital Content Protection



## Other features

- Mechanical lens shutter
- Picture in picture (main/sub input source combinations possible only when using computer and video)
- Anti-theft features with chain opening
- ID assignment for up to 64 units
- Coordinated groups
- Digital vertical keystone correction
- Built-in test pattern
- Selectable 9-language on-screen menu (English, German, French, Spanish, Italian, Russian, Japanese, Chinese, Korean)

# UNIVERSAL DESIGN

## Easy lamp replacement

You can remove the back cover by removing a single screw. This makes it easy to replace a lamp, even if the projector is suspended from the ceiling or tucked in a hard-to-reach space.



## Grooved for easy handling

Grooves on all four sides of the projector's bottom let you get a firm, comfortable grip on the unit and move it safely.

## Blind touch operation key/ New remote control

The keys have pits and projections that let you operate the projector by blind touch. A light can also be turned on to illuminate the control panel, for easy operation in a darkened room. The wireless operation range has been extended to 30 m, giving you control from a greater distance. Thanks to the backlight, you can check all the keys on the remote control even in the dark.





The lens can also be adjusted using the lens adjustment direct key that was newly added to the remote control.

## Ecological-conscious design

Panasonic works from every angle to minimise environmental impact in the product design, production and delivery processes, and in the performance of the product during its life cycle. The PT-D10000E reflects the following ecological considerations.

- Lead-free solder is used to mount components to the printed circuit boards.
- The non-coated cabinet enables easy recycling.
- Lamp power switching further reduces power consumption.
- Auto Power Save activates standby mode when no signal is input.
- The packing case and operating manual are made from recycled paper.

## Optional accessories

Lens	Input signal board*	Frame	Carrying handle
Zoom lens ET-D75LE6 (1.0 - 1.2:1) ET-D75LE1 (1.5 - 2.0:1) ET-D75LE2 (2.0 - 3.0:1) ET-D75LE3 (3.0 - 5.0:1) ET-D75LE4 (5.0 - 8.0:1) ET-D75LE8 (7.9 - 15.0:1)	SD-SDI Input signal board ET-MD77SD1	ET-PFD100	ET-HAD100
Fixed focus lens ET-D75LE5 (0.8:1)	HD/SD Input signal board ET-MD77SD3	<b>Ceiling mount bracket</b> High-ceiling mount bracket ET-PKD100H	
 ET-D75LE1	DVI-D Input signal board ET-MD77DV		
<b>Lamp</b> Replacement lamp unit ET-LAD10000 ET-LAD10000F (four pack)	 ET-LAD10000		

\*The LAN terminal on each board, when mounted, cannot be used because the LAN terminal on the main unit has priority.

## Specifications

<b>DLP™ chip</b>	Panel size	0.95" diagonal (4:3 aspect ratio)
	<b>Display method</b>	DLP™ chip x 3 (R, G, B), DLP™ projection system
	<b>Pixels</b>	1,470,000 (1,400 x 1,050) x 3, total of 4,410,000 pixels
<b>Lamp</b>		250 W UHM™ lamp x 4 (four lamp system)
<b>Brightness</b>		10,000 lumens (four-lamp operation mode)
<b>Contrast ratio</b>		5,000:1 (full on/full off, in Dynamic Iris 3 mode)
<b>Resolution</b>	<b>RGB</b>	1,400 x 1,050 pixels
	<b>Video</b>	(1,600 x 1,200 pixels compatible, compression mode)
		560 TV lines
<b>Lens</b>		Optional powered zoom/focus lenses
<b>Screen size</b>		70 - 600 inches, 4:3 aspect ratio
		(70-300 inches, 4:3 aspect ratio with the ET-D75LE5)
<b>Lens shift</b>		Vertical, Horizontal (powered)
<b>RGB input scanning frequency</b>		f <sub>H</sub> 15-100 kHz, f <sub>V</sub> 24-120 Hz
		Dot clock 20-162 MHz
<b>Component signal</b>		480i, 480p, 576i, 576p, 720/60p, 720/50p, 1035/60i, 1080/25p, 1080/24p, 1080/24sF, 1080/30p, 1080/60i, 1080/50i, 1080/50p, 1080/60p
		f <sub>H</sub> 15.75/15.63 kHz, f <sub>V</sub> 50/60Hz
		(NTSC, NTSC4.43, PAL, PAL60, PAL-N, PAL-M, SECAM)
<b>Terminals</b>	<b>VIDEO IN</b>	BNC x 1, 1.0 Vp-p
	<b>VIDEO OUT</b>	BNC x 1, 1.0 Vp-p
	<b>S-VIDEO IN</b>	Mini DIN 4-pin x 1
	<b>RGB1/YPbPr IN</b>	BNC x 5
	<b>RGB2 IN</b>	D-sub HD 15-pin x 1
	<b>DVI-D IN</b>	24-pin x1, DVI 1.0 compliant, HDCP compatible
	<b>SERIAL IN</b>	D-sub 9-pin female x 2 (RS232C x 1, RS422 x 1)
	<b>SERIAL OUT</b>	D-sub 9-pin male x 1 (RS422 x 1)
	<b>REMOTE 1 IN</b>	M3 jack x1 for wired remote control
	<b>REMOTE 1 OUT</b>	M3 jack x1 for link control
	<b>REMOTE 2 IN</b>	D-sub 9-pin female x 1 for external control (parallel)
	<b>LAN</b>	RJ-45 (10 Base-T/100 Base-TX) x 1, compatible with PLink™
<b>Keystone correction range</b>		±40° (±22° with the ET-D75LE5, ±28° with the ET-D75LE6)
<b>Installation</b>		Front/rear, ceiling/floor

<b>Power cord length</b>	3.0 m (9.9")
<b>Power supply</b>	220-240 V, 15 A, 50 / 60 Hz
<b>Power consumption</b>	1,450 W (25 W in standby mode with fan stopped)
<b>Dimensions (W x H x D)</b>	578 x 320 x 643 mm (22-3/4" x 12-19/32" x 25-5/16") (without lens)
<b>Weight</b>	32 kg (70.5 lbs) without lens
<b>Operating temperature</b>	0 -45 °C (32 -113 °F)
	*The highland mode is for use at high altitudes. When using the unit at altitudes of 1,400 to 2,700 meters, the ambient temperature is 0 °C-40 °C.
<b>Operating humidity</b>	10-80% (no condensation)
<b>Supplied accessories</b>	Power cord, Wireless/wired remote control unit, Batteries for remote control (3V AA battery x2)

## Dimensions

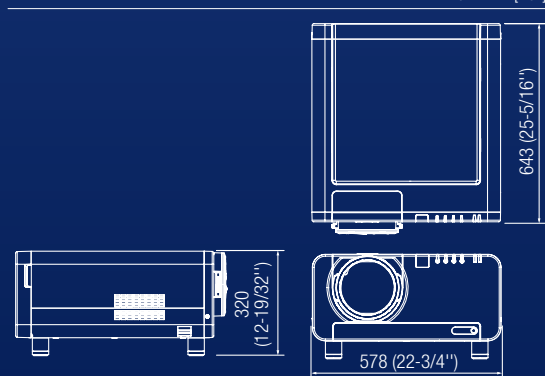

## Shape of the power outlet connection

• AC 220-240V, 16A

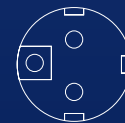

• AC 220-240V, 13A/15A



## Projection distance

Diagonal image size (aspect ratio: 4:3)	Throw distance												
	ET-D75LE1 1.5-2.0:1		ET-D75LE2 2.0-3.0:1		ET-D75LE3 3.0-5.0:1		ET-D75LE4 5.0-8.0:1		ET-D75LE8 7.9-15.0:1		ET-D75LE6 1.0-1.2:1		ET-D75LE5 0.8:1 fixed
	min.	max.	min.	max.	min.	max.	min.	max.	min.	max.	min.	max.	
70"	2.1 m / 6.9	2.7 m / 9.0	2.9 m / 9.2	4.2 m / 13.8	4.3 m / 13.9	7.0 m / 23.2	7.2 m / 23.3	11.3 m / 37.3	11.1 m / 36.4	21.1 m / 69.3	1.4 m / 4.6	1.6 m / 5.4	1.0 m / 3.3
100"	3.0 m / 9.9	3.9 m / 13.1	4.1 m / 13.3	6.0 m / 19.9	6.1 m / 20.0	10.1 m / 33.4	10.2 m / 33.5	16.2 m / 53.4	16.1 m / 52.6	30.3 m / 99.5	2.1 m / 6.7	2.4 m / 7.8	1.4 m / 4.9
200"	6.1 m / 19.9	8.0 m / 26.5	8.2 m / 26.8	12.2 m / 40.1	12.3 m / 40.2	20.4 m / 67.2	20.6 m / 67.3	32.6 m / 107.2	32.5 m / 106.3	61.0 m / 200.3	4.1 m / 13.5	4.8 m / 16.0	3.0 m / 10.0
300"	9.2 m / 30.0	12.1 m / 40.0	12.3 m / 40.3	18.4 m / 60.3	18.5 m / 60.5	30.8 m / 101.0	30.9 m / 101.1	49.0m / 160.9	48.8 m / 160.1	91.7 m / 301.0	6.2 m / 20.2	7.3 m / 24.1	4.6 m / 15.2
400"	12.2 m / 40.1	16.2 m / 53.4	16.4 m / 53.8	24.5 m / 80.6	24.6 m / 80.7	41.1 m / 134.8	41.2 m / 134.9	65.4 m / 214.7	65.2 m / 213.9	122.5 m / 401.8	8.3 m / 27.0	9.8 m / 32.2	—
600"	18.4 m / 60.2	24.4 m / 80.3	24.7 m / 80.8	36.9 m / 121.1	37.0 m / 121.2	61.7 m / 202.4	61.8 m / 202.6	98.2 m / 322.2	98.0 m / 321.4	183.9 m / 603.3	12.4 m / 40.6	14.8 m / 48.5	—

Diagonal image size (aspect ratio: 16:9)	Throw distance												
	ET-D75LE1 1.5-2.0:1		ET-D75LE2 2.0-3.0:1		ET-D75LE3 3.0-5.0:1		ET-D75LE4 5.0-8.0:1		ET-D75LE8 7.9-15.0:1		ET-D75LE6 1.0-1.2:1		ET-D75LE5 0.8:1 fixed
	min.	max.	min.	max.	min.	max.	min.	max.	min.	max.	min.	max.	
70"	2.3m / 7.4	3.0 m / 9.9	3.1 m / 10.0	4.6 m / 15.1	4.7 m / 15.1	7.7 m / 25.4	7.8 m / 25.4	12.3 m / 40.7	12.2 m / 39.8	23.0 m / 75.7	1.6 m / 5.0	1.8 m / 6.0	1.1 m / 3.6
100"	3.3 m / 10.7	4.3 m / 14.3	4.5 m / 14.4	6.6 m / 21.7	6.9 m / 21.7	11.1 m / 36.4	11.2 m / 36.5	17.7 m / 58.3	17.5 m / 57.3	33.1 m / 108.6	2.2 m / 7.2	2.6 m / 8.6	1.6 m / 5.3
200"	8.9 m / 21.7	8.8 m / 29.0	8.9 m / 29.2	13.3 m / 43.8	13.4 m / 43.8	22.3 m / 73.3	22.4 m / 73.3	35.8 m / 116.8	35.4 m / 115.9	66.5 m / 218.4	4.5 m / 14.6	5.3 m / 17.5	3.3 m / 11.0
300"	10.0 m / 32.6	13.2 m / 43.6	13.4 m / 43.9	20.0 m / 65.8	20.1 m / 65.9	33.5 m / 110.1	33.6 m / 110.2	53.4 m / 175.4	53.2 m / 174.5	100.0 m / 328.2	6.7 m / 22.0	8.0 m / 26.3	5.0 m / 16.6
400"	13.3 m / 43.6	17.7 m / 58.3	17.9 m / 58.6	26.7 m / 87.9	26.9 m / 87.9	44.7 m / 147.0	44.9 m / 147.0	71.3 m / 234.0	71.1 m / 233.1	133.4 m / 437.9	9.0 m / 29.3	10.7 m / 35.2	—
600"	20.0 m / 65.5	26.6 m / 87.5	26.9 m / 88.0	40.2 m / 132.0	40.3 m / 132.0	67.2 m / 220.7	67.3 m / 220.7	107.0 m / 351.2	106.8 m / 350.3	200.4 m / 657.5	13.5 m / 44.1	16.1 m / 52.9	—

## NOTES ON USE

### Notes on Projector Placement and Operation:

The projector uses a high-wattage lamp that becomes very hot during operation. Please observe the following precautions.

- Never place objects on top of the projector while it is operating.
- Make sure there is an unobstructed space of 500 mm or more around the projector's exhaust openings.
- Do not stack projector units directly on top of one another for the purpose of multiple (stacked) projection. When stacking projector units, be sure to provide the amount of space indicated below between them. These space requirements also apply to installations where only one projector unit is operating at one time and the other unit is used as a backup.
- If the projector is placed in a box or enclosure, ensure the temperature of the air surrounding the projector is between 0 °C and 35 °C. Also make sure the projector's intake and exhaust openings are not blocked. Take particular care to ensure that hot air from the exhaust openings is not sucked into the intake openings.
- Because the ET-D75LE5 is a fixed short-throw lens, the lens shift function cannot be used with it.

### Operating the Projector Continuously:

- If the projector is to be operated continuously 24 hours a day, use the multi-lamp optical system's alternating lamp operation (lamp changer) function. The projector can be operated continuously 24 hours a day in four-lamp operation mode, but it will automatically operate with three lamps for 8 hours of the 24 hours.
- The lamp replacement cycle duration becomes shorter if the projector is operated repeatedly for short periods.
  - The projector uses a high-voltage mercury lamp that contains high internal pressure. This lamp may break, emitting a large sound, or fail to illuminate, due to impact or extended use. The length of time that it takes for the lamp to break or fail to illuminate varies greatly depending on individual lamp characteristics and usage conditions.
  - The brightness of the lamp will gradually decrease with use.

# Panasonic

Please contact Panasonic or your dealer for a demonstration.



JQA-1617



Weights and dimensions shown are approximate. Specifications are subject to change without notice. This product may be subject to export regulations. UHM is trademark of Matsushita Electric Industrial Co., Ltd. VGA and XGA are trademarks of International Business Machines Corporation. All other trademarks are the property of their respective trademark owners. Projection images simulated.

DLP, DLP logo and DLP Medallion logo are trademarks of Texas Instruments. The PLink trademark is an application trademark in Japan, the United States, and other countries and regions or registered trademarks. (C) 2006 Matsushita Electric Industrial Co.Ltd. All rights reserved. PT-D10KE1-08Nov70K Printed in Japan.