



Table of Contents

Table of Contents	1
Usage Notice	2
<i>Safety Information</i>	2
<i>Precautions</i>	3
<i>Eye Safety Warnings</i>	5
Introduction	6
<i>Product Features</i>	6
<i>Package Overview</i>	7
<i>Product Overview</i>	8
<i>Main Unit</i>	8
<i>Control Panel</i>	9
<i>Connection Ports</i>	10
<i>Wireless Remote Control</i>	11
Installation	12
<i>Connecting the Projector</i>	12
<i>Powering On/Off the Projector</i>	13
<i>Powering On the Projector</i>	13
<i>Powering Off the projector</i>	14
<i>Warning Indicator</i>	14
<i>Adjusting the Projected Image</i>	15
<i>Adjusting the Projector Image Height</i>	15
<i>Adjusting the Projector Zoom / Focus</i>	16
<i>Adjusting Projected Image Size</i>	16
User Controls	17
<i>Control Panel & Remote Control</i>	17
<i>On-Screen Display Menus</i>	20
<i>How to operate</i>	20
<i>Menu Tree</i>	21
<i>Language</i>	22
<i>Management I</i>	23
<i>Management II</i>	25
<i>Image-I</i>	26
<i>Image-II (Computer Mode / Video Mode)</i>	28
<i>Colour Setting</i>	30
Appendices	31
<i>Troubleshooting</i>	31
<i>Replacing the lamp</i>	35
<i>Compatibility Modes</i>	36
<i>Ceiling Mount Installation</i>	37
<i>Optoma Global Offices</i>	38



Safety Information

	The lightning flash with arrowhead within an equilateral triangle is intended to alert the user to the presence of uninsulated "dangerous voltage" within the product's enclosure that may be of sufficient magnitude to constitute a risk of electric shock to persons.
	The exclamation point within an equilateral triangle is intended to alert the user to the presence of important operating and maintenance (servicing) instructions in the literature accompanying the appliance.

WARNING: TO REDUCE THE RISK OF FIRE OR ELECTRIC SHOCK, DO NOT EXPOSE THIS APPLIANCE TO RAIN OR MOISTURE. DANGEROUS HIGH VOLTAGES ARE PRESENT INSIDE THE ENCLOSURE. DO NOT OPEN THE CABINET. REFER SERVICING TO QUALIFIED PERSONNEL ONLY.

Class B emissions limits

This Class B digital apparatus meets all requirements of the Canadian Interference-Causing Equipment Regulations.

Important Safety Instruction

1. Read these instructions -before using this projector.
2. Keep these instructions -for future reference.
3. Follow all instructions.
4. Install in accordance with the manufacturer's instructions

A. Do not block any ventilation openings

To ensure reliable operation of the projector and to protect it from overheating, put the projector in a position and location that will not interfere with its proper ventilation. For example, do not place the projector on a bed, sofa, carpet, or similar surface that may block the ventilation openings. Do not put it in an enclosure, such as a bookcase or a cabinet that may keep air from flowing through its ventilation openings.

B. Do not use this projector near water or moisture. To reduce the risk of fire or electric shock, do not expose the projector to rain or moisture.

C. Do not install near any heat sources, such as radiators, heaters, stoves or other apparatus (including amplifiers) that produce heat.

5. Clean only with a dry cloth.
6. Only use attachments/accessories specified by the manufacturer.
7. Refer all servicing to qualified service personnel. Servicing is required when the projector has been damaged in any way:
 - Such as power supply cord or plug is damaged.
 - Liquid has been spilled or objects have fallen into the apparatus.
 - The projector has been exposed to rain or moisture, does not operate normally, or has been dropped.











Do not attempt to service this projector yourself. Opening or removing covers may expose you to dangerous voltages or other hazards. Please call Optoma to be referred to an authorized service center near you.

8. Do not let objects or liquids enter the projector -as they may touch dangerous voltage points or short-out parts that could result in a fire or electric shock.
9. See projector enclosure for safety related markings.
10. The projector should not be adjusted or repaired by anyone except properly qualified service personnel.



Precautions

Follow all warnings, precautions and maintenance as recommended in this user's guide to maximize the life of your unit.

-  Warning - Do not look into the projector's lens when the lamp is on. The bright light may hurt your eyes.
-  Warning - To reduce the risk of fire or electric shock, do not expose this product to rain or moisture.
-  Warning - Please do not open or disassemble the product as this may cause electric shock.
-  Warning - When changing the lamp, please allow unit to cool down, and follow all changing instructions.
-  Warning - This product will detect the life of the lamp itself. Please be sure to change the lamp when it shows warning messages (refer to page 34).
-  Warning - Reset the "Reset Lamp Hours" function from the On Screen Display "Management II" menu after replacing the lamp module (refer to page 25).
-  Warning - When switching the projector off, please ensure the projector completes its cooling cycle before disconnecting power.
-  Warning - Turn on the projector first and then the signal sources.
-  Warning - Do not use lens cap when projector is in operation.
-  Warning - When the lamp reaches the end of its life, it will burn out and may make a loud popping sound. If this happens, the projector will not turn back on until the lamp module has been replaced. To replace the lamp, follow the procedures listed under "Replacing the Lamp". (see page 35)



Usage Notice

Do:

- ❖ Turn off the product before cleaning.
- ❖ Use a soft cloth moistened with mild detergent to clean the display housing.
- ❖ Disconnect the power plug from AC outlet if the product is not being used for a long period of time.

Don't:

- ❖ Block the slots and openings on the unit provided for ventilation.
- ❖ Use abrasive cleaners, waxes or solvents to clean the unit.
- ❖ Use under the following conditions:
 - In extremely hot, cold or humid environments.
 - In areas susceptible to excessive dust and dirt.
 - Near any appliance that generates a strong magnetic field.
 - In direct sunlight.

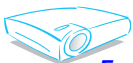

Eye Safety Warnings



- ■ Avoid staring directly into the projector beam at all times.
- ■ Minimize standing facing into the beam. Keep your back to the beam as much as possible.
- ■ A stick or laser pointer is recommended to avoid the need for the user to enter the beam.
- ■ Ensure that projectors are located out of the line of sight from the screen to the audience; this ensures that, when presenters look at the audience, they do not also have to stare at the projector lamp. The best way to achieve this is by ceiling-mounting rather than floor or table-mounting the projector.
- ■ When projector is used in a classroom, adequately supervise students when they are asked to point out something on the screen.
- ■ In order to minimize the lamp power needed, use room blinds to reduce ambient light levels.



Product Features

*This product is an XGA single chip 0.55" DLP™ projector.
Outstanding features include:*

- ◆ True XGA, 1024 x 768 addressable pixels
- ◆ Single chip Dark Chip2™ DLP™ technology
- ◆ NTSC/NTSC4.43/PAL/PAL-M/PAL-N/SECAM and HDTV compatible (480i/p, 576i/p, 720p, 1080i)
- ◆ Multi-Auto functions: Auto detection, Auto image and Auto saving the adjustments
- ◆ Full function remote control
- ◆ User friendly multilingual on screen display menu
- ◆ Advanced digital keystone correction and high quality full screen image re-scaling
- ◆ User friendly control panel
- ◆ SXGA compression and VGA, SVGA re-sizing
- ◆ Mac compatible



Package Overview

This projector comes with all the items shown below. Check to make sure your unit is complete. Contact your dealer immediately if anything is missing.



❖ Due to the difference in applications for each country, some regions may have different accessories.



Projector with lens cap



Power Cord 1.8m



VGA Cable 1.8m



Remote Controller



2 x AAA Batteries



Carrying Case



SCART RGB/S-Video
Adaptor
(available in European
version only)

Documents :

- User's Guide
- Quick Start Card
- Warranty Card



Product Overview

Main Unit

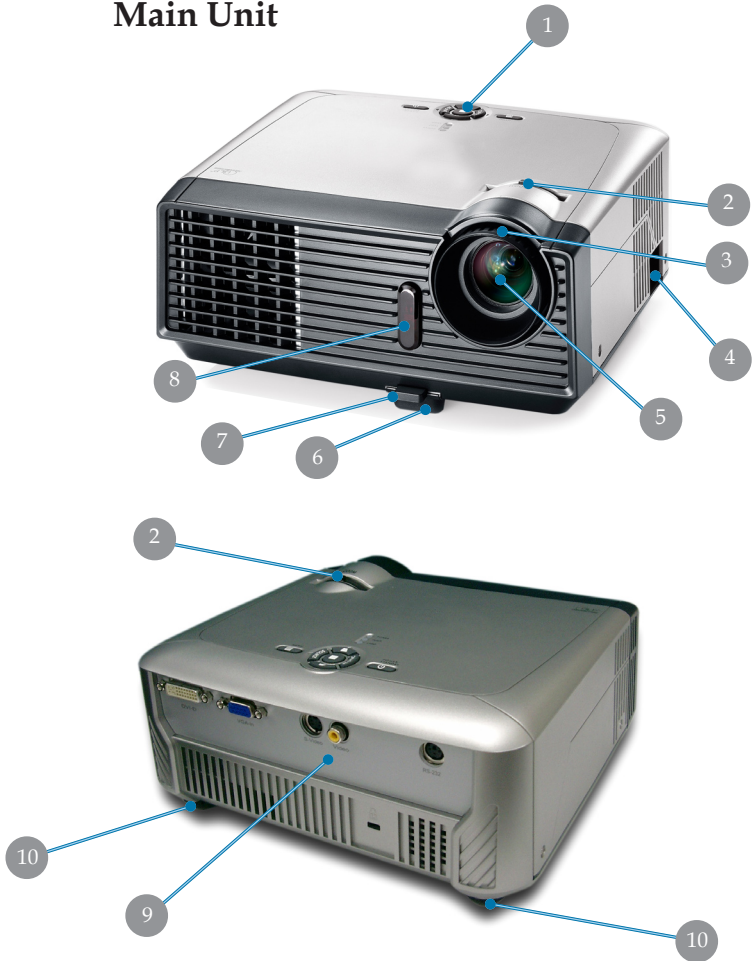

- | | |
|------------------|-------------------------|
| 1. Control Panel | 6. Elevator Foot |
| 2. Zoom Lever | 7. Elevator Button |
| 3. Focus Ring | 8. IR Receivers |
| 4. Power Socket | 9. Connection Ports |
| 5. Zoom Lens | 10. Tilt Adjusting Feet |

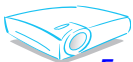

Control Panel

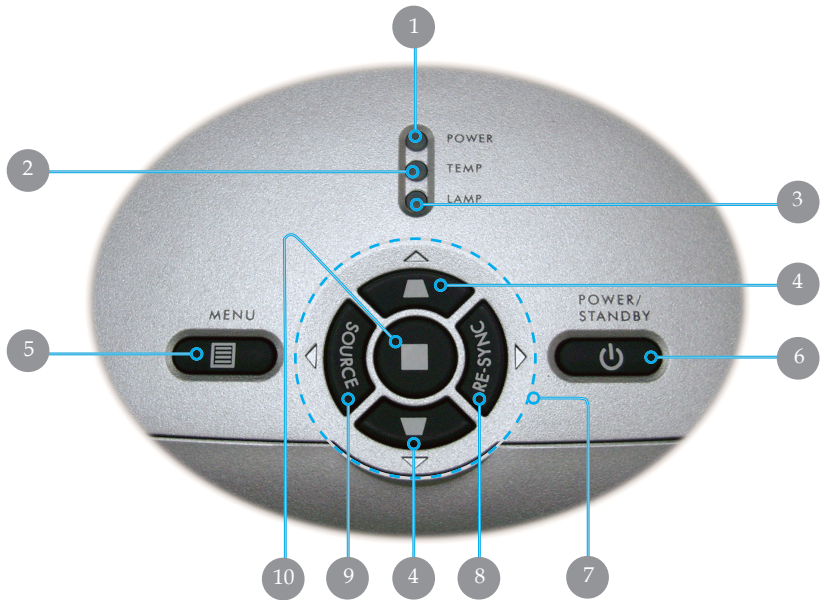

1. Power Indicator LED
2. Temp Indicator LED
3. Lamp Indicator LED
4. Keystone Correction
5. Menu (On/Off)
6. Power/Standby
7. Four Directional Select Keys
8. Re-Sync
9. Source
10. Enter



Connection Ports

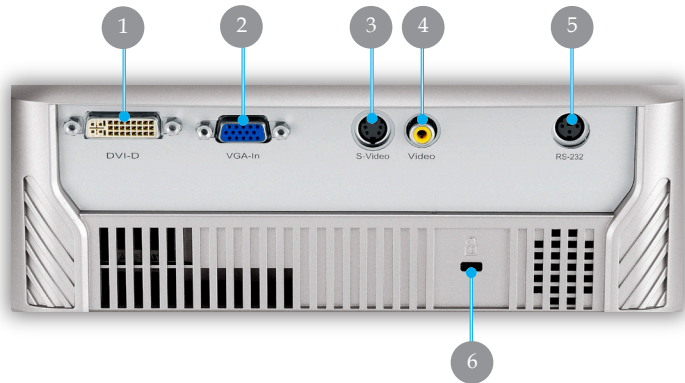

1. DVI-D Input Connector (with HDCP)
2. PC Analog signal/SCART RGB/HDTV/Component Video Input Connector
3. S-Video Input Connector
4. Composite Video Input Connector
5. RS232 Connector
6. Kensington™ Lock Port

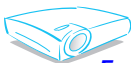

Wireless Remote Control

1. IR LED
2. Power
3. Re-Sync
4. Display Mode
5. Keystone Correction
6. Number Buttons
7. Clear
8. Sleep Timer
9. Video
10. S-Video Source
11. Source Lock
12. VGA Source
13. Color Setting
14. Menu
15. Enter
16. Four Directional Select Keys
17. Brightness
18. Zoom
19. Display Format
20. Hide
21. Freeze

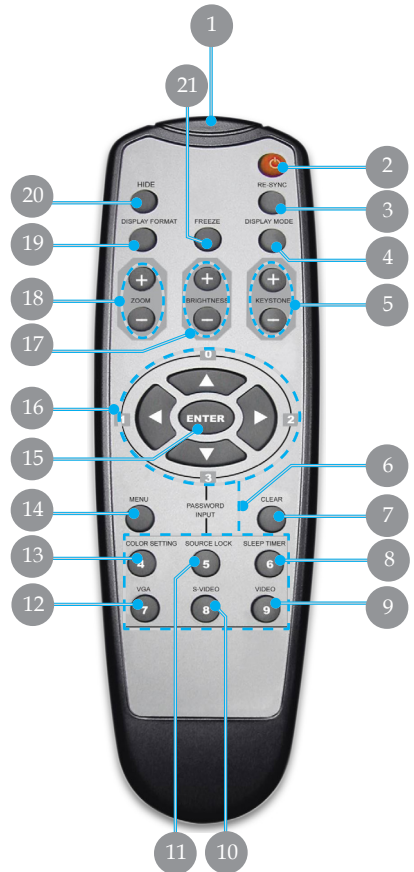

Connecting the Projector



❖ Due to the difference in applications for each country, some regions may have different accessories.

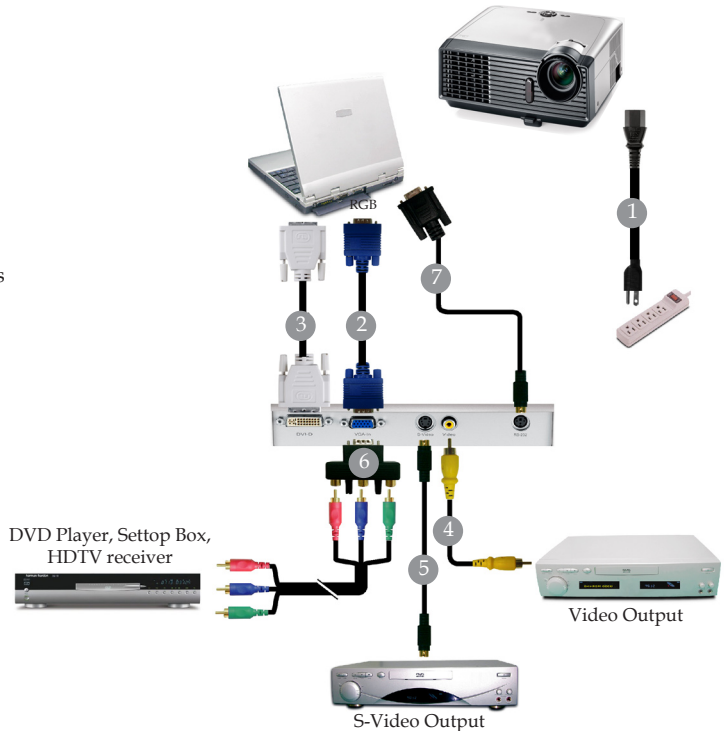

- 1.....Power Cord
- 2.....VGA Cable
- 3.....DVI to DVI Cable(Optional Accessory)
- 4.....Composite Video Cable(Optional Accessory)
- 5.....S-Video Cable (Optional Accessory)
- 6.....D-15 to RCA Adapter for YPbPr (Optional Accessory)
- 7.....RS232 Cable (Optional Accessory)

❖ To ensure the projector works well with your computer, please set the display mode of your graphic card less than or equal to 1024 X 768 resolution. Make sure the timing of the display mode is compatible with the projector. Refer to the "Compatibility Modes" section on page 36.



Powering On/Off the Projector

Powering On the Projector

1. Remove the lens cap. ❶
 2. Ensure that the power cord and signal cable are securely connected. The Power LED will **Flash Green**.
 3. Turn on the lamp by pressing “Power/Standby” button on the control panel. ❷ And the Power LED will turn **Green**. The first time you use the projector, you can select your preferred language from quick menu after the startup screen display.
 4. Turn on your source (computer, notebook, video player, etc.). The projector will detect your source automatically.
- ❖ If you connect multiple sources at the same time, use the “Source” button on the control panel or remote control to switch.



❖ Turn on the projector first and then the signal sources.



Powering Off the Projector

1. Press the “Power/Standby” button to turn off the projector lamp, you will see a message “

Wait 1 minute before you can switch on again.

Press Power key again to confirm.

Press “Enter” key to remove this warning.

displayed on the projector’s screen. Press the “Power/Standby” button again to confirm, otherwise the message will disappear after 5 seconds.

Please note that if the ► key is pressed instead, the projector will enter the “Picture Mute” mode and no image will be displayed. To exit the “Picture Mute” mode, press the “Power/Standby” button again.

2. The cooling fans continue to operate for about 30 seconds for cooling cycle and the Power LED will turn green. When the Power LED begins flashing, the projector has entered standby mode.

If you wish to turn the projector back on, you must wait until the projector has completed the cooling cycle and has entered standby mode. Once in standby mode, simply press “Power/Standby” button to restart the projector.

3. Disconnect the power cord from the electrical outlet and the projector.
4. Do not turn on the projector immediately following a power off procedure.

Warning Indicator

- ❖ When the “LAMP” indicator lights solid red, the projector will automatically shut itself down. Please contact your local reseller or service center. See page 38.
- ❖ When the “TEMP” indicator lights solid red for about 60 seconds, it indicates the projector has been overheated. The projector will automatically shut itself down. Under normal conditions, the projector can be switched on again after it has cooled down. If the problem persists, you should contact your local dealer or our service center. See page 38.
- ❖ When the “TEMP” indicator flashes red for about 5 seconds, it indicates the fan failed. Please contact your local dealer or our service center. See page 38.



Adjusting the Projected Image

Adjusting the Projector Image Height

The projector is equipped with an elevator foot for adjusting the image height.

To raise the image:

1. Press the elevator button **1**.
2. Raise the image to the desired height angle **2**, then release the button to lock the elevator foot into position.
3. Use **3** to fine-tune the display angle.

To lower the image:

1. Press the elevator button.
2. Lower the image, then release the button to lock the elevator foot into position.
3. Use **3** to fine-tune the display angle.

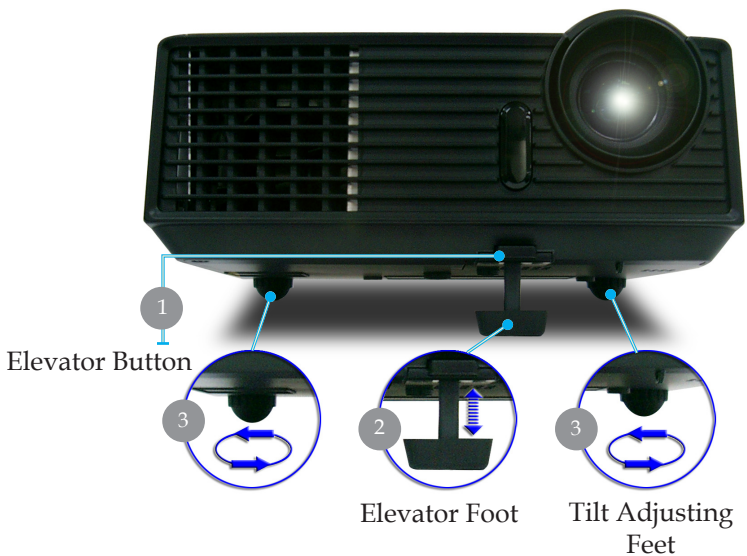

Adjusting the Projector Zoom / Focus

You may turn the zoom lever to zoom in or out. To focus the image, rotate the focus ring until the image is clear. The projector will focus at distances from 4.9 to 39.4 feet (1.5 to 12.0 meters) with mechanical travel.



Adjusting Projection Image Size

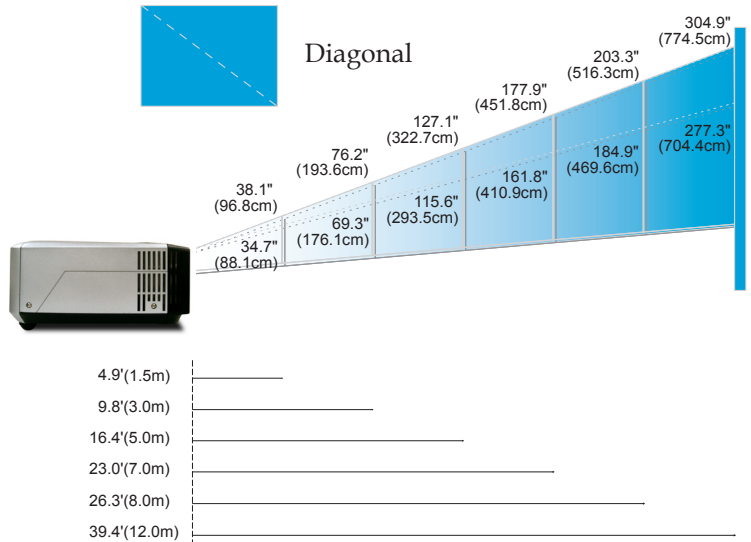

Screen (Diagonal)	Max.	38.1"(96.8cm)	76.2"(193.6cm)	127.1"(322.7cm)	177.9"(451.8cm)	203.3"(516.3cm)	304.9"(774.5cm)
	Min.	34.7"(88.1cm)	69.3"(176.1cm)	115.6"(293.5cm)	161.8"(410.9cm)	184.9"(469.6cm)	277.3"(704.4cm)
Screen Size	Max.(WxH)	30.5" x 22.9" (77.4 x 58.1cm)	61.0" x 45.7" (154.9 x 116.2cm)	101.7" x 76.3" (258.2 x 193.6cm)	142.3" x 106.7" (361.4 x 271.1cm)	162.6" x 122.0" (413.0 x 309.8cm)	243.9" x 182.9" (619.6 x 464.7cm)
	Min.(WxH)	27.8" x 20.8" (70.5 x 52.9cm)	55.4" x 41.6" (140.9 x 105.7cm)	92.5" x 69.4" (234.8 x 176.1cm)	129.4" x 97.1" (328.7 x 246.5cm)	147.9" x 110.9" (375.7 x 281.8cm)	221.8" x 166.4" (563.5 x 422.6cm)
Distance		4.9'(1.5m)	9.8'(3.0m)	16.4'(5.0m)	23.0'(7.0m)	26.3'(8.0m)	39.4'(12.0m)

❖ This graph is for user's reference only.



Control Panel & Remote Control

There are two ways for you to control the functions: Remote Control and Control Panel.

Control Panel



Using the Control Panel

Power/Standby

- ▶ Refer to the “Power On/Off the Projector” section on pages 13-14.

Source

- ▶ Press “Source” to choose RGB, Component-p, Component-i, S-Video, Composite Video and HDTV sources.

Menu

- ▶ Press “Menu” to launch the on screen display (OSD) menu. To exit OSD, press “Menu” again.

Keystone ▼/▲

- ▶ Adjusts image distortion caused by tilting the projector (± 15 degrees).

Four Directional Select Keys

- ▶ Use ▲ ▼ ◀ ▶ to select items or make adjustments to your selection.

Enter

- ▶ Confirm your selection of items.

Re-Sync

- ▶ Automatically synchronizes the projector to the input source.



Using the Remote Control

Remote Control



Power

- ▶ Refer to the “Power On/Off the Projector” section on pages 13-14.

Re-Sync

- ▶ Automatically synchronizes the projector to the input source.

Hide

- ▶ Press “Hide” to hide image, press again to restore display of the image.

Display Format

- ▶ Display the “Display Format” section of the on screen display menu to select the desired aspect ratio.

Freeze

- ▶ Press “Freeze” to pause the screen image.

Display Mode

- ▶ Select the display mode from PC, Movie, Game, sRGB and User.

Keystone ▼ / ▲

- ▶ Adjusts image distortion caused by tilting the projector (± 15 degrees).

Brightness

- ▶ Adjust the brightness of the image.

Zoom

- ▶ Press “D-Zoom” button to zoom in of an image.

Four Directional Select Keys

- ▶ Use ▲ ▼ ◀ ▶ to select items or make adjustments to your selection.

Enter

- ▶ Confirm your selection of items.

Menu

- ▶ Press “Menu” to launch the on screen display menu. To exit OSD, press “Menu” again.

Clear

- ▶ Clear your selection.

Color Setting

- ▶ Adjust the Red, Green, Blue, Yellow, Cyan and Magenta colors for advanced adjustment of the individual colors.

Source Lock

- ▶ Select auto detection all connector ports or lock current connector port.



Sleep Timer

- ▶ Sets the countdown timer interval.

VGA

- ▶ Press "VGA" to choose VGA connector.

S-Video

- ▶ Press "S-Video" to choose S-Video source.

Video









- ▶ Choose composite video source.



On Screen Display Menus

The Projector has multilingual On Screen Display menus that allow you to make image adjustments and change a variety of settings. The projector will automatically detect the source.

How to operate

1. To open the OSD menu, press “Menu   keys to select any item in the main menu. While making a selection on a particular page, press  or “Enter” key to enter sub menu.
3. Use   keys to select the desired item and adjust the settings by   key.
4. Select the next item to be adjusted in the sub menu and adjust as described above.
5. Press “Menu 

Main Menu	
Language	Management - I
Image-I	Image-II
Display mode	Presentation Bright Movie sRGB User
Brightness	<input type="text"/>
Contrast	<input type="text"/>
White intensity	<input type="text"/>
Colour temp.	<input type="text"/>
Saturation	<input type="text"/>
Sharpness	<input type="text"/>
Film mode	On off
Sub Menu	Setting



Menu Tree

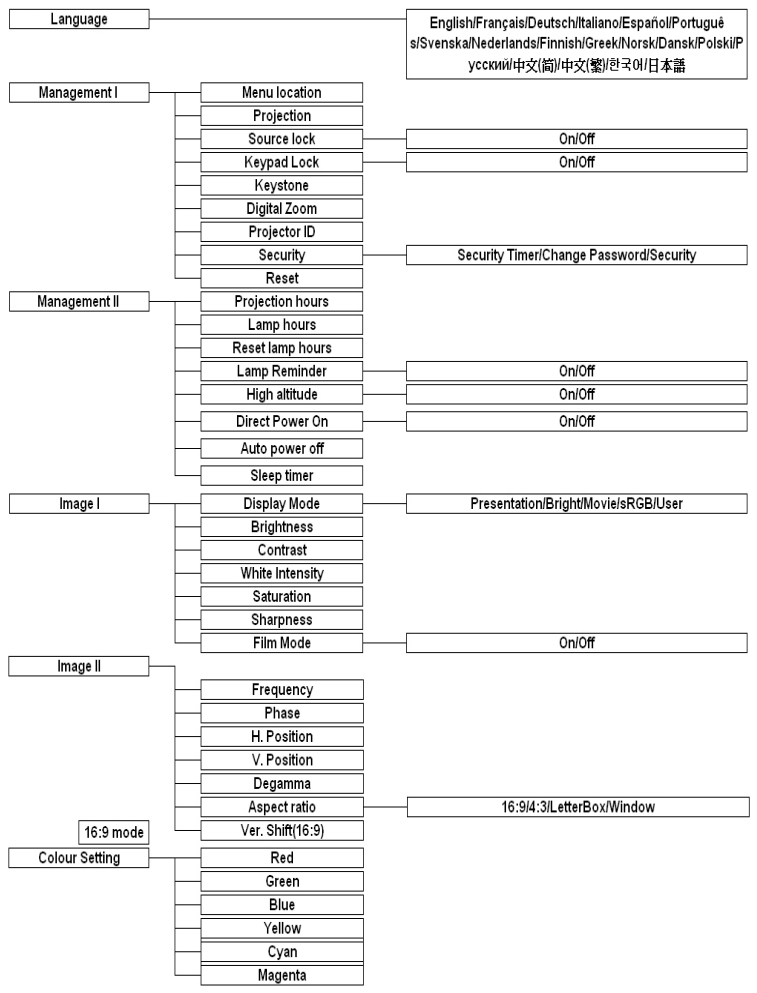



Image-I	Image-II	Colour setting
Language	Management - I	Management - II
English	Nederlands	繁體中文
Français	Finnish	简体中文
Deutsch	Greek	日本語
Italiano	Danish	한국어
Español	Norsk	
Portugués	Polski	
Svenska	Русский	

Language

Language

Choose the multilingual OSD menu . Use the ▲ or ▼ key to select your preferred language.

Press “Enter” to finalize the selection.



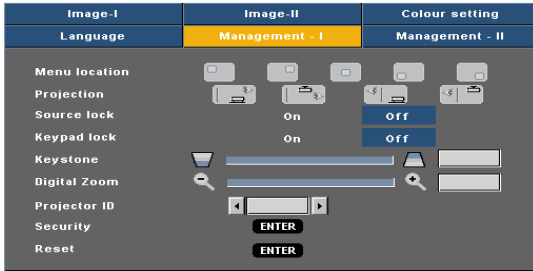

Management I

Menu Location

Choose the menu location on the display screen.

Projection

- ▶  Front-Desktop

The factory default setting.

- ▶  Rear-Desktop

When you select this function, the projector reverses the image so you can project behind a translucent screen.

- ▶  Front-Ceiling

When you select this function, the projector turns the image upside down for ceiling-mounted projection.

- ▶  Rear-Ceiling

When you select this function, the projector reverses and turns the image upside down at same time. You can project from behind a translucent screen with ceiling mounted projection.

Source Lock

When this function is turned off, the projector will search for other signals if the current input signal is lost. When this function is turned on, it will search specified connection port.

Keypad Lock

When the keypad lock function is on, the control panel will be locked, but the projector can still be operated by the remote control. If canceling this function, use the remote control or press the "Enter" key on the control panel for 3 seconds to turn it off.



User Controls

Keystone (Keystone Correction)

Adjusts image distortion caused by tilting projector. (± 15 degrees)

Digital Zoom

- ▶ Press the ◀ to reduce the size of an image.
- ▶ Press the ▶ to magnify an image on the projection screen.

Projector ID

Allows RS232 control of an individual projector. Range 01-99.

Security

- ▶ Security Timer: Can be select the time (month/day/hour) function to set the number of hours the projector can be used. Once the time has elapsed you will be requested to enter your password again.

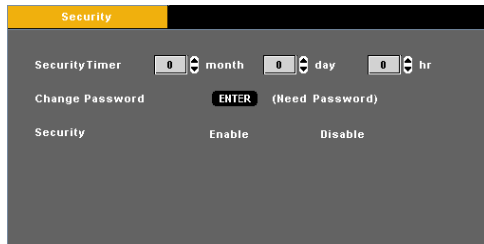

- ▶ Change Password

Use number buttons to select your password, and then press "Enter" key to confirm your selection.

1. Scroll down to highlight Change Password, and press "Enter" to input old password.
2. The Password is 4 digits, DEFAULT VALUE is "0000" (first time).
3. Enter new Password (4 digits) and press "Enter".
4. Enter new Password again to confirm and press "Enter".

- ▶ Security

- Enable: Choose "Enable" to use security verification when the turning on the projector.
- Disable: Choose "Disable" to be able to switch on the projector without password verification.

Reset

Choose "Yes" to return the display parameters on all menus to the factory default settings.

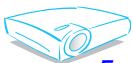
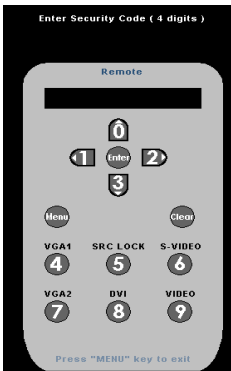

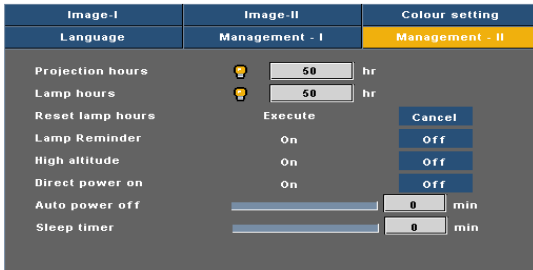

Management II

Projection Hours

Displays the projection time.

Lamp Hours

Displays the cumulative lamp operating time.

Reset Lamp Hours

Resets the lamp life hour counter after replacing the lamp.

Lamp Reminding

Choose this function to show or to hide the warning message when the changing lamp message is displayed. The message will appear 30 hours before end of life.

High Altitude

Choose "On" to turn on High Altitude mode. Operates the fans at full speed continuously to allow for proper high altitude cooling of the projector.

Direct Power On

Choose "On" to turn on Direct Power On mode. Operates the projector will automatically power on without press the "Power" key.

Auto Power Off

Sets the countdown timer interval. The countdown timer will start, when there is no signal being sent to the projector. Then projector will automatically power off when the countdown has finished.

Sleep Timer

Sets the countdown timer interval. The timer will begin, with or without a signal input. Then the projector will automatically power off then the sleep timer countdown has finished.



User Controls



Image-I (Computer Mode / Video Mode)

Display Mode

There are many factory presets optimized for various types of images.

- ▶ Presentation : For computer or notebook.
- ▶ Bright : For brightness optimization.
- ▶ Movie: For home theater.
- ▶ sRGB: For standard color.
- ▶ User: Memorize user's settings.

Brightness

Adjust the brightness of the image.

- ▶ Press the ◀ to darken image.
- ▶ Press the ▶ to lighten the image.

Contrast

The contrast controls the degree of difference between the lightest and darkest parts of the picture. Adjusting the contrast changes the amount of black and white in the image.

- ▶ Press the ◀ to decrease the contrast.
- ▶ Press the ▶ to increase the contrast.

White Peaking

Use the white peaking control to set the white peaking level of DMD chip. 0 stands for minimal peaking, and 10 stands for maximum peaking. If you prefer a brighter image, adjust towards the maximum setting. For a smooth and more natural image, adjust towards the minimum setting.

Color Temp.

Adjust the color temperature. At higher temperature, the screen looks colder; at lower temperature, the screen looks warmer.





❖ “Saturation” and “Film Mode” function are only supported under Video mode.

Saturation

Adjusts a video image from black and white to fully saturated colour.

- ▶ Press the ◀ to decrease the amount of saturation in the image.
- ▶ Press the ▶ to increase the amount of saturation in the image.

Sharpness

Adjusts the sharpness of the image.

- ▶ Press the ◀ to decrease the sharpness.
- ▶ Press the ▶ to increase the sharpness.

Film Mode

Choose “On” to turn on Film Mode to eliminate the sawtooth edge on the projected image (if any) when the DVD movie format is “film” which is at lower frame rate.





Language	Management - I	Management - II
Image-I	Image-II	Colour setting
Frequency		
Phase		
Hor. position		
Ver. position		
Degamma		
Aspect ratio	4 : 3 16 : 9 LetterBox Window	
Ver. shift (16:9)		

Image-II (Computer Mode/ Video Mode)



❖ “Frequency”, “Phase”, “H.Position” and “V.Position” function are only supported under Video mode.

Frequency

“Frequency” changes the display data frequency to match the frequency of your computer’s graphic card. If you experience a vertical flickering bar, use this function to make an adjustment.

Phase

“Phase” synchronizes the signal timing of the display with the graphic card. If you experience an unstable or flickering image, use this function to correct it.

H.Position (Horizontal Position)

- ▶ Press the ◀ to move the image left.
- ▶ Press the ▶ to move the image right.

V. Position (Vertical Position)

- ▶ Press the ◀ to move the image down.
- ▶ Press the ▶ to move the image up.

Degamma

This allows you to choose a degamma table that has been fine-tuned to bring out the best image quality for the input.

Aspect Ratio

Use this function to choose your desired aspect ratio.

- ▶ 4:3 : The input source will be scaled to fit the projection screen.
- ▶ 16:9 : The input source will be scaled to fit the width of the screen.
- ▶ LBX: This format is for non-16x9, letterbox source and for users who use external 16x9 lens to display 2.35:1 aspect ratio using full resolution.
- ▶ Window: When a 4:3 image is bigger than a 16:9 screen, select the “Window” mode to fit the image onto the screen without changing the projection distance.



User Controls

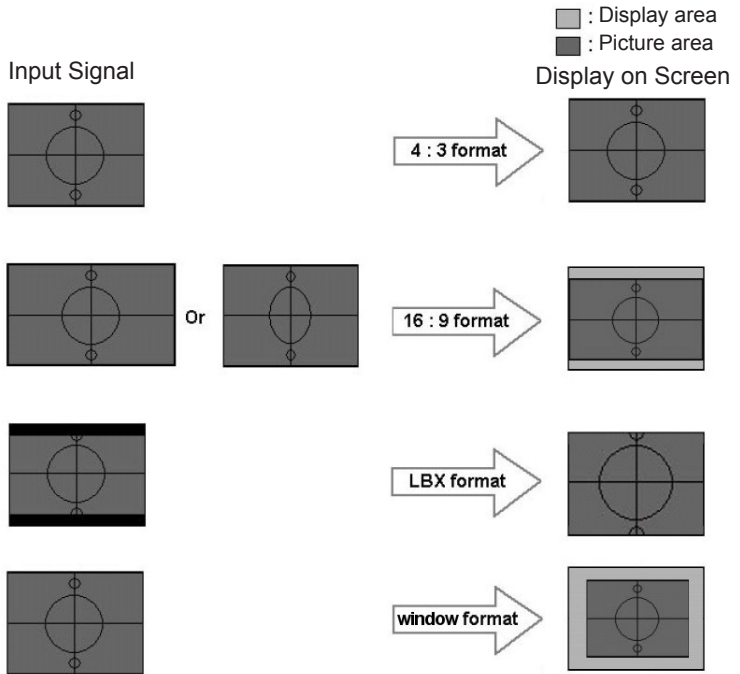

Note

- ❖ Ver. Shift (16:9): Image Position at window mode will also be moved accordingly.

Ver. Shift (16:9)

Adjust the image position up or down, when you select the aspect ratio of 16:9.

- ▶ Press the ◀ to move the image down.
- ▶ Press the ▶ to move the image up.





Colour Setting

Colour Setting

Adjust the Red, Green, Blue, Yellow, Cyan and Magenta colors for advanced adjustment of the individual colors.

- : Full range color adjustment that effects all color space.
- : Enhanced individual color adjustment that effects itself only.

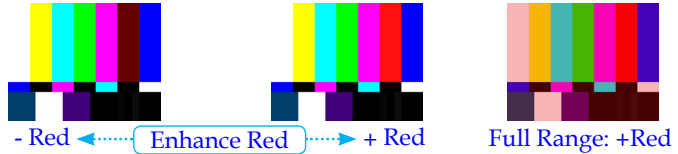

Each display mode (Present/ Bright/ Movie/ sRGB/ User) has its own color temperature and can memorize user's selection.

When you adjust the color setting item, the color temperature will be set as "User" automatically. And this set "User" is the same for all display mode.



Different color setting will be memorized at 4 different source groups. But they will be same under same source.

1. DVI / VGA.....>
2. Component-p (480p/576p/720p/1080i).....>
3. Component-i (480i/576i).....>
4. Video / S-Video.....>



When we adjust color setting the current color temperature will be memorized before it auto switch to "User". Because the memorized color temperature will be a base of "User". For example:

- 1.) Colour temp. is Low.



- 2.) User create his favorite color based on "Low" setting of colour temperature. So when user switch "Colour temp." to "User", will find the image color temperature close to "Low".



Troubleshooting

If you experience trouble with the projector, refer to the following information. If the problem persists, please contact your local reseller or service center.

Problem: No image appears on screen

- ▶ Ensure all the cables and power connections are correctly and securely connected as described in the “Installation” section.
- ▶ Ensure the pins of connectors are not crooked or broken.
- ▶ Check if the projection lamp has been securely installed. Please refer to the “Replacing the lamp” section.
- ▶ Make sure you have removed the lens cap and the projector is switched on.
- ▶ Ensure that the “Hide” feature is not turned on.

Problem: Partial, scrolling or incorrectly displayed image

- ▶ Press “Re-Sync” on the remote control or control panel.
- ▶ If you are using a PC:
 - For Windows 3.x:
 1. In the Windows Program Manager, double click the “Windows Setup” icon in the Main group.
 2. Verify that your display resolution setting is less than or equal to 1280 x 1024.

For Windows 95, 98, 2000, XP:

1. Open the “My Computer” icon, the “Control Panel” folder, and then double click on the “Display” icon.
2. Select the “Settings” tab
3. Click on the “Advanced Properties” button.

If the projector is still not projecting the whole image, you will also need to change the monitor display you are using. Refer to the following steps.

4. Verify the resolution setting is less than or equal to 1280 x 1024 resolution.



5. Select the “Change” button under the “Monitor” tab .
 6. Click on “Show all devices.” Next, select “Standard monitor types” under the SP box; choose the resolution mode you need under the “Models” box.
- ▶ If you are using a Notebook:
1. First, follow the steps above to adjust resolution of the computer.
 2. Press the toggle output settings. Example :[Fn]+[F4]

Compaq ⇒	[Fn]+[F4]	Packard	⇒	[Fn]+[F4]
Dell ⇒	[Fn]+[F8]	Hewlett	⇒	[Fn]+[F4]
Gateway ⇒	[Fn]+[F4]	NEC ⇒	[Fn]+[F3]	
IBM ⇒	[Fn]+[F7]	Toshiba ⇒	[Fn]+[F5]	

Mac Apple:

System Preference ⇒ Display ⇒ Arrangement ⇒ Mirror display

- ▶ If you experience difficulty changing resolutions or your monitor freezes, restart all equipment including the projector.

Problem: The screen of the Notebook or PowerBook computer is not displaying a presentation

- ▶ If you are using a Notebook PC:

Some Notebook PCs may deactivate their own screens when a second display device is in use. Each has a different way to be reactivated. Refer to your computer’s documentation for detailed information.

Problem: Image is unstable or flickering

- ▶ Use “Phase” to correct it.
- ▶ Change the monitor color setting from your computer.

Problem: Image has vertical flickering bar

- ▶ Use “Frequency” to make an adjustment.
- ▶ Check and reconfigure the display mode of your graphic card to make it compatible with the product.

Problem: Image is out of focus

- ▶ Adjusts the Focus Ring on the projector lens.



- ▶ Make sure the projection screen is between the required distance 4.9 to 39.4 feet (1.5 to 12.0 meters) from the projector. See page 16.

Problem: The image is stretched when displaying 16:9 DVD

The projector automatically detects 16:9 DVD and adjusts the aspect ratio by digitizing to full screen with 4:3 default setting.

If the image is still stretched, you will also need to adjust the aspect ratio by referring to the following:

- ▶ Please select 4:3 aspect ratio type on your DVD player if you are playing a 16:9 DVD.
- ▶ If you can't select 4:3 aspect ratio type on your DVD player, please select 4:3 aspect ratio in the on screen menu.

Problem: Image is reversed

- ▶ Select "Management → Projection" from the OSD and adjust the projection direction.

Problem: Lamp burns out or makes a popping sound

- ▶ When the lamp reaches its end of life, it will burn out and may make a loud popping sound. If this happens, the projector will not turn on until the lamp module has been replaced. To replace the lamp, follow the procedures in the "Replacing the Lamp".

Problem: LED lighting message

Message	Power-LED (GREEN/RED/ORANGE)	Temp-LED	Lamp-LED
Standby State (Input power cord)	Red	○	○
Lamp lighting	Flash Green	○	○
Power on	Green	○	○
Power off (Cooling)	Flash Red	○	○
Error (Lamp fail)	○	○	☀
Error (Thermal fail)	○	○	☀
Error (Fan fail)	○	○	Flashing
Error (Over Temp.)	○	☀	○
Error (Lamp Breakdown)	○	○	☀



Steady light => ☀
No light => ○



Problem: Message Reminders

- ▶ Fan failed:

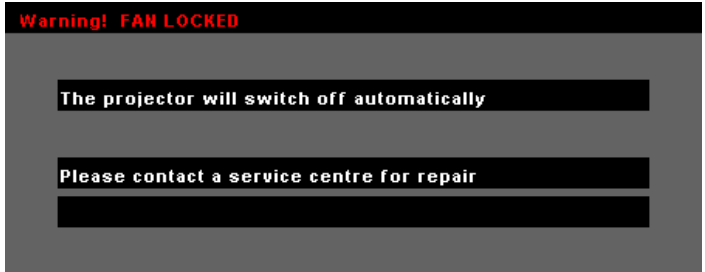

- ▶ Replacing the lamp:



- ▶ Temperature Error:

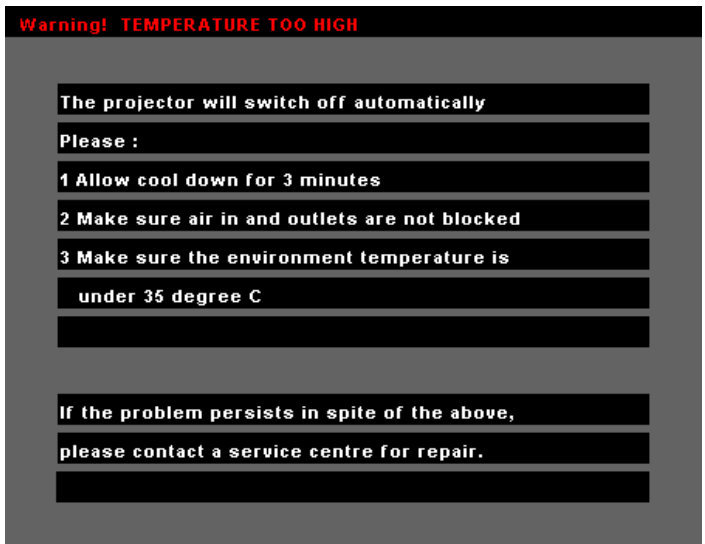

Replacing the lamp

The projector will detect the lamp life itself. It will show you a warning message

“  **Lamp life exceeded.** ” When you see this message, change the lamp as soon as possible.

Make sure the projector has been cooled down for at least 30 minutes before changing the lamp.



 Warning: Lamp compartment is hot! Allow it to cool down before changing lamp!

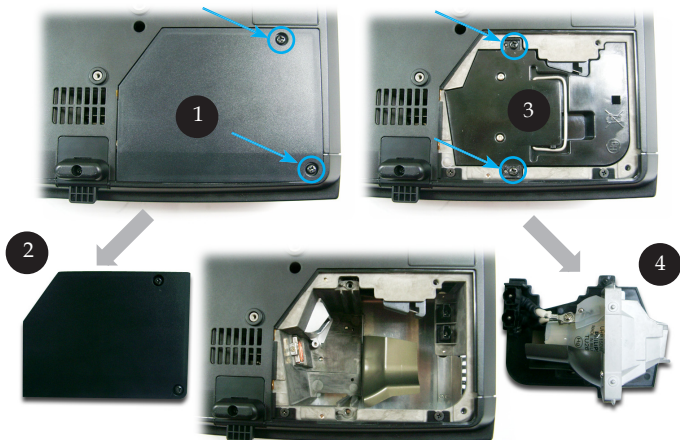

 Warning: To reduce the risk of personal injury, do not drop the lamp module or touch the lamp bulb. The bulb may shatter and cause injury if it is dropped.

Lamp Replacing Procedure:

1. Turn off the power to the projector by pressing the Power/ Standby button.
2. Allow the projector to cool down at least 30 minutes.
3. Disconnect the power cord.
4. Use a screwdriver to remove the screw from the cover. ❶
5. Push up and remove the cover. ❷
6. Remove the 2 screws from the lamp module. ❸
7. Pull out the lamp module. ❹

To replace the lamp module, reverse the previous steps.



Compatibility Modes

Mode	Resolution	(ANALOG)		(Digital)	
		V.Frequency (Hz)	H.Frequency (kHz)	V.Frequency (Hz)	H.Frequency (kHz)
VESA VGA	640 x 350	70	31.5	70	31.5
VESA VGA	640 x 350	85	37.9	85	37.9
VESA VGA	640 x 400	85	37.9	85	37.9
VESA VGA	640 x 480	60	31.5	60	31.5
VESA VGA	640 x 480	72	37.9	72	37.9
VESA VGA	640 x 480	75	37.5	75	37.5
VESA VGA	640 x 480	85	43.3	85	43.3
VESA VGA	720 x 400	70	31.5	70	31.5
VESA VGA	720 x 400	85	37.9	85	37.9
VESA SVGA	800 x 600	56	35.2	56	35.2
VESA SVGA	800 x 600	60	37.9	60	37.9
VESA SVGA	800 x 600	72	48.1	72	48.1
VESA SVGA	800 x 600	75	46.9	75	46.9
VESA SVGA	800 x 600	85	53.7	85	53.7
VESA XGA	1024 x 768	60	48.4	60	48.4
VESA XGA	1024 x 768	70	56.5	70	56.5
VESA XGA	1024 x 768	75	60.0	75	60.0
VESA XGA	1024 x 768	85	68.7	85	68.7
* VESA SXGA	1152 x 864	70	63.8	70	63.8
* VESA SXGA	1152 x 864	75	67.5	75	67.5
* VESA SXGA	1152 x 864	85	77.1	85	77.1
* VESA SXGA	1280 x 1024	60	63.98	60	63.98
MAC LC 13"	640 x 480	66.66	34.98	***	***
MAC II 13"	640 x 480	66.68	35	***	***
MAC 16"	832 x 624	74.55	49.725	***	***
MAC 19"	1024 x 768	75	60.24	***	***
* MAC	1152 x 870	75.06	68.68	***	***
MAC G4	640 x 480	60	31.35	***	***
i MAC DV	1024 x 768	75	60	***	***
* i MAC DV	1152 x 870	75	68.49	***	***
* i MAC DV	1280 x 960	60	60.0	***	***



Remark :

- 1.> "*" compressed computer image.
- 2.> The column of Digital is support DVI-D connector.



Ceiling Mount Installation

1. To prevent damaging your projector, please use the ceiling mount package for installation.
2. If you wish to use a third party ceiling mount kit, please ensure the screws used to attached a mount to the projector met the following specifications:



❖ Please note that damage resulting from incorrect installation will invalidate the warranty.



Warning:
1.> If you buy the ceiling mount from other company, please ensure that there is at least 10cm distance between the bottom cover of the projector and the ceiling.
2.> Don't install the projector near the air condition and the heater, avoid flowing into the projector directly that caused it shot down.

- ▶ **Screw type: M2.6**
- ▶ **Maximum screw length: 10mm**
- ▶ **Minimum screw length: 8mm**

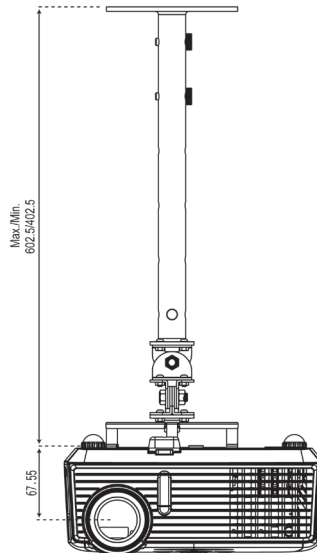
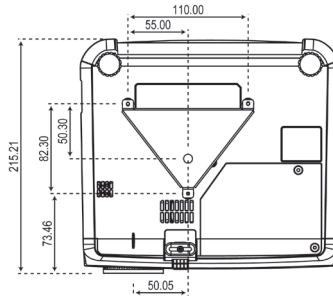



Optoma Global Offices

For service or support please contact your local office.

USA

715 Sycamore Drive
Milpitas, CA 95035, USA
www.optomausa.com

Tel : 408-383-3700
Fax: 408-383-3702
Service : service@optoma.com

Canada

120 West Beaver Creek Road Unit #9
Richmond Hill, ON L4B 1L2, Canada
Tel : 905-882-4228
www.optoma.com

Fax: 905-882-4229

Europe

42 Caxton Way, The Watford Business Park
Watford, Hertfordshire, WD18 8QZ, UK

Tel : +44 (0) 1923 691 800

Fax: +44 (0) 1923 691 888

www.optomaeurope.com

Service Tel : +44 (0)1923 691865

Service : service@tsc-europe.com

Taiwan

5F., No. 108, Minchiuan Rd.
Shindian City, Taipei Taiwan 231,
R.O.C.

Tel : +886-2-2218-2360

Fax: +886-2-2218-2313

www.optoma.com.tw

Service : services@optoma.com.tw asia.optoma.com

Hong Kong

Unit 901, 9/F., Vogue Centre, No. 696
Castle Peak Road, Kowloon, Hong Kong

Tel : +852-2396-8968

Fax: +852-2370-1222

www.optoma.com.cn

China

5F, No. 1205, Kaixuan Rd.,
Changning District
Shanghai, 200052, China

Tel : +86-21-62947376

Fax: +86-21-62947375

www.optoma.com.cn

Latin America

715 Sycamore Drive
Milpitas, CA 95035, USA
www.optoma.com.br

Tel : 408-383-3700

Fax: 408-383-3702

www.optoma.com.mx

