

EPSON®

dreamio™

Home Entertainment Projector EMP-TWD1

User's Guide

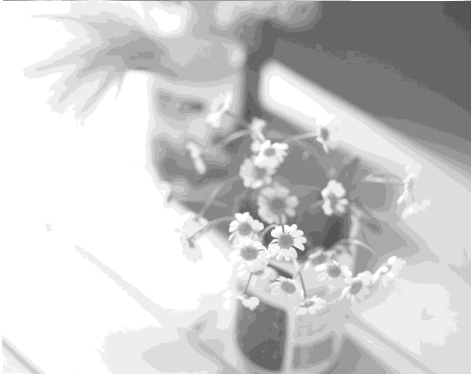
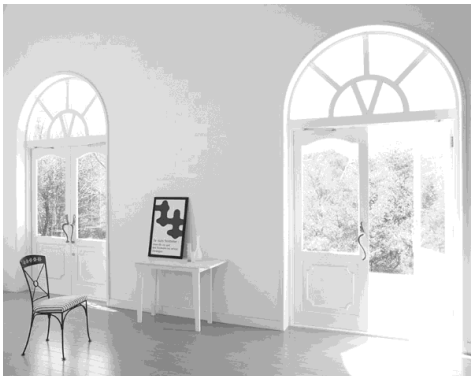

Unpacking the projector

Refer to the following checklist and make sure you have received all of the items. Contact the place of purchase if items are missing.

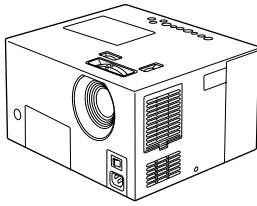

Main Unit

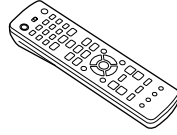

Remote Control



AA type dry cell batteries (2 pcs.)

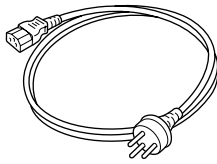

Power cable (3m)





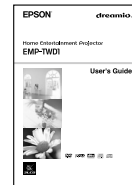





















Lens cover



User's Guide (this manual)

Notations used in this guide

	<p>Indicates content which may cause projector damage or malfunction.</p>
	<p>Indicates additional information and points which may be useful to know regarding a topic.</p>
	<p>Indicates a page where useful information regarding a topic can be found.</p>
	<p>Indicates operating methods and the order of operations. The procedure indicated should be carried out in the order of the numbered steps.</p>
	<p>Indicates remote control or main unit buttons.</p>
<p>“(Menu name)”</p>	<p>Indicates menu items and messages which are displayed on screen. Example: “Brightness”</p>
 	<p>Depending on the type of disc, the functions and operations which can be performed may be different. These marks inform you of the type of disc being used.</p> <div style="display: flex; justify-content: space-around; align-items: flex-end;"> <div style="text-align: center;"> </div> <div style="text-align: center;"> </div> <div style="text-align: center;"> </div> <div style="text-align: center;"> </div> <div style="text-align: center;"> </div> <div style="text-align: center;"> </div> <div style="text-align: center;"> </div> <div style="text-align: center;"> </div> <div style="text-align: center;"> </div> </div>

Contents

Safety Instructions	2
Use and Storage	5
About Discs	7
Part Names	8
Preparing the Remote Control	11

Quick Start

Installation	13
Projection distance and screen size	13
Connecting the power cable and turning the main power switch ON	13
Disc Playback	14
Playing a disc and projecting	14
Adjusting the projection position and volume	15
Stopping playback	16
Turning off the power	16
Basic Operations During Playback	17
Temporarily freezing playback (pause)	17
Reverse search/forward search	17
Reviewing playback from a position 10 seconds before	18
Skip	18
Frame advance	18
Slow motion playback	19
Temporarily using the projector's light as illumination (Break)	19
Selecting a picture quality to suit the conditions of the room (Color Mode)	19
Temporarily stopping the audio (Mute)	19

Advanced Operations

Becoming a playback expert	20
Changing the brightness of the display window (Dimmer)	20
Playback from a DVD menu	21
PBC (playback control) playback	22
MP3/WMA, JPEG playback	23
Playback by selecting the chapter or track number	25
Designated time playback (time search)	26
Looping playback of a favorite scene (A-B repeat playback)	27
Looping playback (repeat play)	28
Playing in the order of your choice (program play)	30
Playback at random (random play)	31
Changing the audio language	32
Changing the subtitles display	33
Changing the angle	33
Making operations from the menu bar	34
Auto-standby, goodnight timer (Sleep timer) settings	35
For better image quality (Progressive mode)	36
Tray lock	36
Becoming a Projection Expert	37
Connecting to other video equipment	37
Projecting images from external video equipment	38

Becoming an Audio Expert	39
Listening with headphones	39
Connecting to audio equipment with an optical digital input	40
Connecting a subwoofer	40
Selecting Sound Mode	41
Adjusting high pitched tones	41
Adjusting the audio playback level	42
Adjusting the audio input level of external audio equipment	42

Settings and Adjustments

Settings Menu Operation and Functions	43
Using the settings menu	43
Settings menu list	44
Language code list	46
“DIGITAL AUDIO OUTPUT” settings and output signals	46
Country (area) code list	47
Picture Quality Menu Operations and Functions	48
Using the Picture Quality menu	48
Picture Quality menu list	49
Information Menu Operation and Functions	50
Using the Information menu	50
Information menu list	51

Appendix

Troubleshooting	52
Reading the indicators	52
When the indicators provide no help	54
Maintenance	56
Cleaning	56
Consumables replacement period	57
How to replace consumables	58
Optional Accessories and Consumables	60
Projection Distance and Screen Size	60
Specifications / Compliant Resolutions	61
Glossary	64
Index	65
Address List	66

Safety Instructions

Important information

Read the following important information about your unit.

Important safety information

Warning :

To reduce the risk of fire or electric shock, do not expose this apparatus to rain or moisture.

Warning :

Never look into the projector lens when the lamp is switched on as the bright light can damage your eyes. Never let children look into the lens when it is on.

Warning :

Never open any covers on the projector except the lamp cover. Dangerous electrical voltages inside the projector can cause severe injury. Except as specifically directed in the User's Guide supplied, do not attempt to service this product yourself. Refer all servicing to qualified service personnel.

Warning :

Keep the plastic bags for the projector, accessories and optional parts out of the reach of children. Children covering their heads with bags may result in death by suffocation. Be particularly careful around small children.

Class 1 LASER Product

Caution :

Do not open the top cover. There are no user serviceable parts inside the unit.

Caution :

When you replace the lamp, never touch the new bulb with your bare hands. The invisible residue left by the oil on your hands may shorten the bulb life. Use a cloth or gloves to handle the new bulb.



Caution :

To reduce the risk of electric shock, do not remove cover (or back). No user-serviceable parts inside. Refer servicing to qualified service personnel.



This symbol is intended to alert the user to the presence of uninsulated "dangerous voltage" within the product's enclosure that may be of sufficient magnitude to constitute a risk of electric shock to persons.



This symbol is intended to alert the user to the presence of important operating and maintenance (servicing) instructions in the literature accompanying the unit.

Important safety instructions

Follow these safety instructions when setting up and using the projector :

- Read these instructions.
- Keep these instructions.
- Heed all warnings.
- Follow all instructions.
- Do not use this apparatus near water.
- Clean only with dry cloth.
- Do not block any ventilation openings. Install in accordance with the manufacturer's instructions.
- Do not install near any heat sources such as radiators, heat registers, stoves, or other apparatus (including amplifiers) that produce heat.
- Do not override the safety purpose of the polarized or grounding-type plug. A polarized plug has two blades with one wider than the other. A grounding type plug has two blades and a third grounding prong. The wide blade or the third grounding prong are provided for your safety. If the provided plug does not fit into your outlet, consult an electrician for replacement of the obsolete outlet.
- Protect the power cord from being walked on or pinched particularly at plugs, convenience receptacles, and the point where they exit from the unit.
- Only use attachments/accessories specified by the manufacturer.
- Use only with the cart stand, tripod, bracket, or table specified by the manufacturer, or sold with the unit. When a cart is used, use caution when moving the cart/unit combination to avoid injury from tip-over.



- Unplug this unit during lightning storms or when unused for long periods of time.

- Refer all servicing to qualified service personnel. Servicing is required when the unit has been damaged in any way, such as the power-supply cord or plug is damaged, liquid has been spilled or objects have fallen into the apparatus, the apparatus has been exposed to rain or moisture, does not operate normally, or has been dropped.
- Do not expose this unit to water or place objects containing liquids on this unit.
- Do not place the source of a naked flame, such as a lit candle, on this unit.
- Connect this unit to an earthed electrical outlet.
- Ensure there is at least 20 cm between the exhaust vent and any walls, and so on.
- Ensure there is at least 10 cm between the air intake vent and any walls, and so on.
- Do not project when the lens cover is on. It is possible that the lens cover may melt from the heat and cause burns or injuries. To interrupt the projection, press [Image On/Off] during projection.
- Do not leave this unit or the remote control with its batteries installed in such places as the inside of a car with the windows closed, in direct sunlight, near the intake/exhaust of an air conditioner or heater, or in places where the temperature rises above normal. This may have a negative effect upon the internal parts of this unit and cause heat deformation or fire.
- When unplugging the power plug/power connector, do not pull on the power cable. Make sure you grasp the plug or connector part, then unplug.
- Do not set the volume too high from the outset. A loud sound may be produced suddenly that may cause damage to the speaker or your hearing. As a precaution, lower the volume before you switch off this unit then raise it gradually after you switch it back on.
- When using headphones, do not turn the volume up too loudly. You may adversely affect your hearing when listening at loud volumes over extended periods of time.
- When maintaining this unit, remove the power plug/power connector from the wall outlet. If not, you run the risk of an electric shock.
- Do not place the projector on an unstable cart, stand, or table.
- Use the type of power source indicated on the projector. If you are not sure of the power available, consult your dealer or local electricity company.
- Place the projector near a wall outlet where the plug can be easily unplugged.
- Check the specifications of the power cable. Using an inappropriate power cable could result in fire or electric shock. The power cable supplied with the projector is intended to comply with power supply requirements for the country of purchase.
- Take the following precautions when handling the plug. Failure to comply with these precautions could result in fire or electric shock.
 - Do not insert the plug into an outlet with dust present.
 - Insert the plug firmly into the outlet.
 - Do not handle the plug with wet hands.
- Do not overload wall outlets, extension cables, or integral convenience receptacles. This can cause fire or electric shock.
- Do not place the projector where the cable can be stepped on. It may result in fraying or damage to the plug.
- Unplug the projector from the wall outlet before cleaning. Use a damp cloth for cleaning. Do not use liquid or aerosol cleaners.
- Do not block the slots and opening in the projector case. They provide ventilation and prevent the projector from overheating. Do not place the projector on a sofa, rug, or other soft surface, or in a closed-in cabinet unless proper ventilation is provided.
- Never push objects of any kind through cabinet slots. Never spill liquid of any kind into the projector.
- Unplug the projector from the wall outlet and refer servicing to qualified service personnel under the following conditions:
 - When the power cable or plug is damaged or frayed.
 - If liquid has been spilled into the projector, or it has been exposed to rain or water.
 - If it does not operate normally when you follow the operating instructions, or if it exhibits a distinct change in performance, indicating a need for service.
 - If it has been dropped or the housing has been damaged.

- The internal projector components consist of many glass parts such as the lens and projection lamp. The lamp is fragile, and can easily break. If the lamp breaks, handle the projector with extreme care to avoid injury from broken glass, and contact your dealer or the nearest address provided on page 66 for repairs. Particular care should be taken when the projector is installed to a ceiling, as small pieces of glass may fall down when the lamp cover is removed. Be very careful not to allow such pieces of glass to get into the eyes or mouth.
- Material or paper may get stuck against the air filter underneath the projector while it is in use. Remove anything from underneath the projector that might get stuck against the air filter in this way.
- Never try to remove the lamp immediately after use. Doing so will result in serious burns. Before removing the lamp, turn off the power supply and wait the time specified on page 58 to allow the lamp to cool completely.
- A mercury lamp with high internal pressure is used as the projector's light source. Mercury lamps may make a loud noise when they break. Handle the lamp with extreme care while observing the following. If the following points are not observed, injury or poisoning may result.
 - Do not damage the lamp or subject it to any impacts.
 - Do not use the lamp after the lamp replacement period has elapsed. Once the lamp replacement period has elapsed, the possibility of the lamp breaking becomes greater. When the lamp replacement message appears, replace the lamp with a new one as soon as possible.
 - The gases inside mercury lamps contain mercury vapor. If the lamp breaks, immediately ventilate the room to prevent the gases that are released when the lamp breaks from being inhaled or coming into contact with the eyes or mouth.
 - Do not bring your face close to the projector while it is in use, in order to prevent the gases that are released when the lamp breaks from being inhaled or coming into contact with the eyes or mouth.
 - If the lamp breaks and needs to be replaced with a new lamp, contact the place of purchase or the nearest address provided on page 66 to carry out the replacement. If the lamp breaks, pieces of broken glass may get scattered around inside the projector.
- Particular care should be taken when the projector is installed to a ceiling, as small pieces of glass may fall down when the lamp cover is removed. If cleaning the projector or replacing the lamp yourself, be very careful not to allow such pieces of glass to get into the eyes or mouth. If the lamp breaks and gas from the lamp or fragments of broken glass are inhaled or get into the eyes or mouth, or if any other ill effects are noticed, immediately seek medical advice. In addition, consult your local regulations regarding proper disposal and do not place in the trash.
- If there is an electrical storm, do not touch the power plug, otherwise you may receive an electric shock.
- Clean the inside of the projector periodically. If the inside of the projector has not been cleaned for a long time, dust may build up and cause fire or electric shocks. Contact your dealer or the nearest address provided on page 66 to clean inside the projector at least once a year. A charge will be levied for this service.
- If using a remote control that takes batteries, keep these batteries out of the reach of children. Batteries are choking hazards and can be very dangerous if swallowed. If the batteries are swallowed, seek medical assistance immediately.
- When replacing batteries, take the following precautions.
 - Replace the batteries as soon as they run out.
 - If the batteries leak, wipe away battery fluid with a soft cloth. If fluid gets on your hands, wash immediately.
 - Do not expose batteries to heat or flame.
 - Dispose of used batteries according to local regulations.
 - Remove the batteries if you won't be using the projector for a long period of time.
- Do not stand on the projector or place heavy objects on it.

Use and Storage

Take note of the following advice in order to prevent malfunction and damage.

Notes on handling and storage

- Use and store this unit within the operating temperature range and storage temperature range as specified in this manual.
- Do not install the unit in a place prone to vibration or shock.
- Do not install the unit close to television, radio or video equipment that generates magnetic fields. This may have a negative effect when projecting the playback of audio and image with this unit, and may cause this unit to malfunction. In the event that such symptoms occur, move the unit further away from any television, radio and video equipment.
- Do not install this machine on an incline.
- Do not move this unit during playback. This may damage the disc or cause malfunction.
- Avoid using or storing this unit in cigarette or other smoke filled places, or in rooms containing a large amount of dust. This may cause degradation of the image quality.
- Do not touch the projection lens with your bare hands. If fingerprints or marks are left on the face of the lens, the image will not be projected clearly. Make sure the lens cover is securely in place when not in use.
- EPSON will not be held responsible for damage arising from projector or lamp failure outside the range of that which is covered in your warranty terms.

Condensation

If you move this unit from a cold place into a warm room, or, if the room in which this unit is installed is heated rapidly, condensation (moisture) may form internally or on the lens surface. If condensation forms, it may not only cause incorrect operation such as weakening of the image, but also damage the disc and/or parts. In order to prevent against condensation, setup this unit in the room approximately one hour before it is to be used. If by some chance condensation does form, turn on the main power switch then wait one to two hours before use. Do not use the lamp during this time.

Lamp

This machine uses a mercury lamp with a high internal pressure as its light source. Mercury lamps have the following characteristics.

- Lamp brightness decreases once the rated lamp usage time has passed.
- When the lamp reaches the end of its life, it may enter a state where it will no longer light, or it may explode with a loud noise due to impact, deterioration, or the expiration of its usage time.
- Depending on the individual difference of each lamp and the conditions of use, there is a considerable difference in the time it takes for the lamp to reach the end of its life. To provide against contingencies, prepare a replacement lamp in advance.
- The potential for the lamp to explode increases once the lamp usage time has been exceeded. When the lamp replacement message appears, promptly replace the lamp with a new one.

LCD panel

- Although the liquid crystal panel is made using very precise high technology, you may see some black pixels, or pixels that are always lit red, blue, or green. You may also be able to see lines with irregular brightness or color. These are normal characteristics of liquid crystal panels, and are not indicative of any malfunction. Be aware of this fact.
- Do not leave this unit projecting a still image over a long period of time. It is possible that remnants of the image may remain (screen burn). You may be able to avoid screen burn by switching off the power and leaving the projector for a while. If the screen burn does not disappear, contact your dealer for advice.  p. 66

When moving this unit

- Make sure the lens cover is securely in place.
- Remove the disc and close the disc tray.
- Move the projector, holding it as shown in the following illustration.

Be careful not to damage the mesh covering the speaker with your hands.

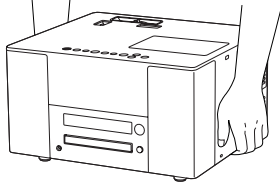

Transportation cautions

- Many glass and precision parts are used within this unit. In order to prevent impact during transportation, re-use the box and protective packaging you received at the time of purchase.

If you no longer have the original packing, protect the outside of this unit with shock absorbing material to protect it from impact, place it inside a strong box and make sure it is clearly labeled for the transportation of precision equipment.

- Take off the lense cap and wrap it.
- If using a courier service for transportation, inform them that this unit contains precision equipment and should be handled accordingly.

* Your warranty does not cover any damages that may occur to this product during transportation.





Copyright

- This unit is equipped with Macrovision copy protection. The intellectual property rights to the patent of this copy protection technology are owned by the Macrovision company of America, and others. When employing this technology, a license is required from the Macrovision company. The Macrovision company does not authorize the use of this technology except for a limited range of intended purposes, including home use. Further, remodeling, disassembly, and reverse engineering are prohibited.
- Reproduction of a disc for the purposes of broadcast, projection in public, public musical performance, or rental (regardless of compensation, remuneration, or lack thereof) without the permission of the copyright owner, is strictly prohibited.

About Discs

Readable disc types

The following discs can be played.

DVD video	Audio CD
	
Video CD/SVCD (Super Video CD)	
	 Video CD
PBC (Playback control) equipped Video CD (version 2.0 compliant).	
CD-R/CD-RW	
Only discs recorded in the following formats can be reproduced. <ul style="list-style-type: none"> • Audio format (finalized) • Video CD format • SVCD format • MP3/WMA, JPEG discs recorded in accordance with ISO9660 standard 	
DVD-R/DVD-RW	
Only discs recorded in the DVD video format (finalized) can be reproduced.	

- You cannot play DVD videos if the disc region code does not correspond to the region code label on the side of this unit.
- The performance and tonal quality of copy-control CD discs that do not conform to the compact disc (CD) standard cannot be guaranteed with this unit. CDs that conform to the CD standard will bear the following compact disc logo mark. Check what is displayed on the packaging of the audio disc.



- This unit conforms to the NTSC, PAL, and SECAM television signal formats.
- In the case of DVD video, SVCD, and Video CD, playback functions may be limited by the intentions of the software producers. As this unit plays back the contents of a disc according to the intentions of the software producers, certain functions may not work if performed. Refer to the attached user information of the disc being played.

- Depending on how a DVD-R, DVD-RW, CD-R, or CD-RW has been recorded, or if a disc is dirty, smeared, scratched, or warped, some discs may not be readable, or playback may take some time.
- Only the audio of the following discs can be reproduced.
 - MIX-MODE CD ·CD-G ·CD-EXTRA
 - CD TEXT

Unreadable disc types

- The following discs cannot be played. It is possible to damage the speaker with the noise generated if these discs are played back by mistake.
 - DVD-R/DVD-RW recorded in the VR format
 - DVD-ROM ·CD-ROM ·PHOTO CD
 - DVD+R ·DVD+RW ·DVD-RAM
 - DVD audio ·SACD ·DVD-R DL
- Round discs with a diameter other than 8 cm or 12 cm
- Specially made non-circular (heart, polygon shaped, and so on) discs

Disc Handling

- Avoid touching the playback side with your bare hands.
- Make sure you store discs in their cases when not in use.
- Avoid storing your discs in places with high humidity or in direct sunlight.
- If the playback surface of the disc is dirty with dust or fingerprints, the image and audio quality may deteriorate. When the playback surface is dirty, gently wipe the disc clean with a soft dry cloth, starting from the center of the disc then moving outwards.

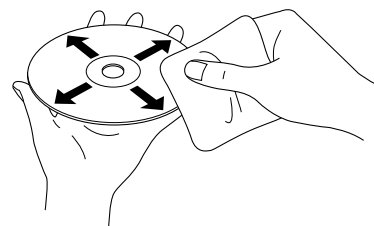

- Do not use cleaning products such as benzine, or anti-static products designed for analog records.
- Do not glue paper or stickers on to a disc.

Part Names

Front

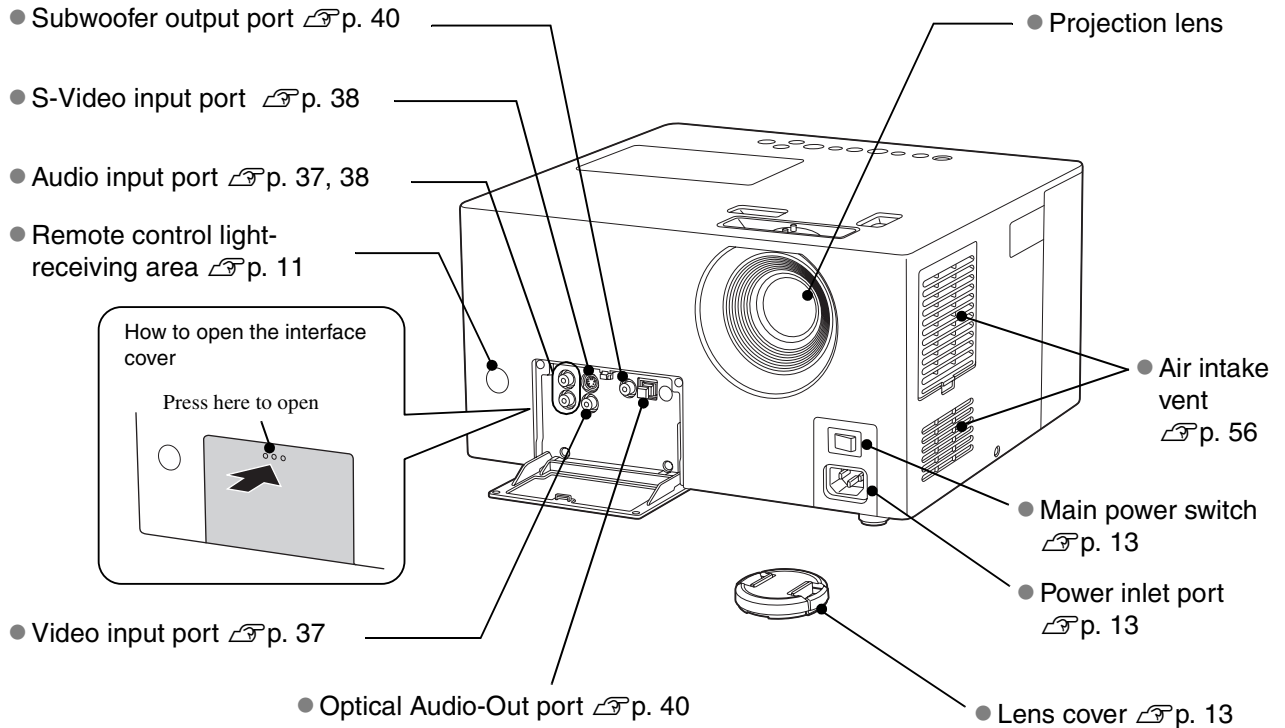

Rear

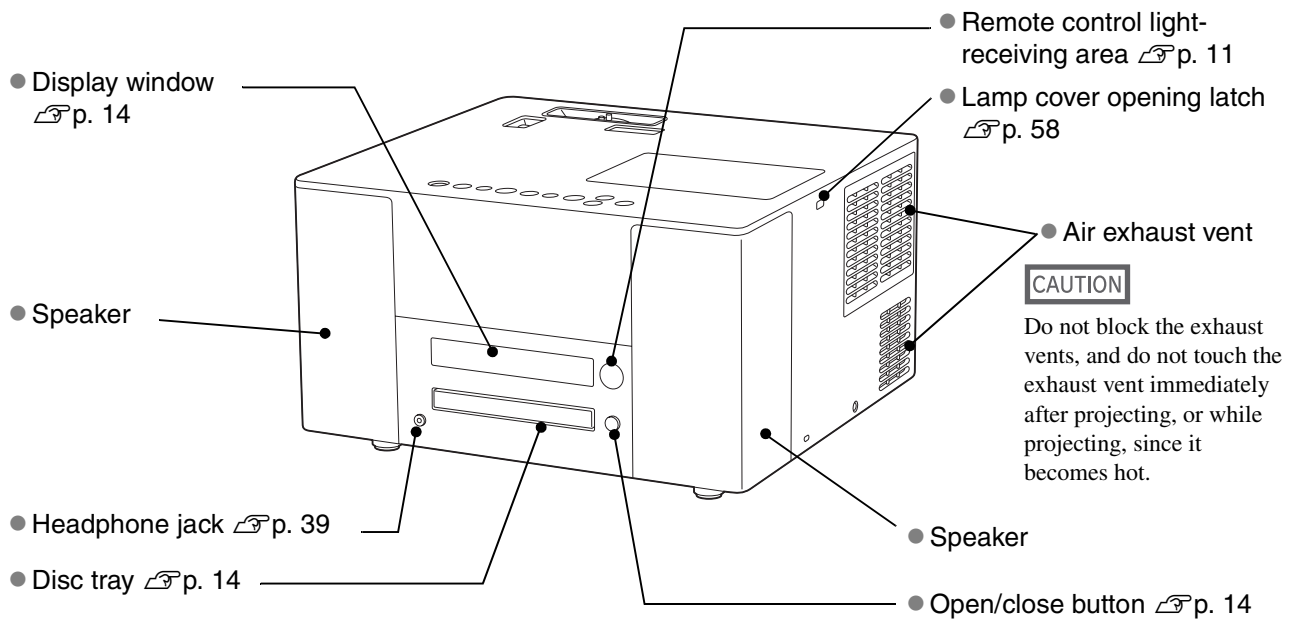

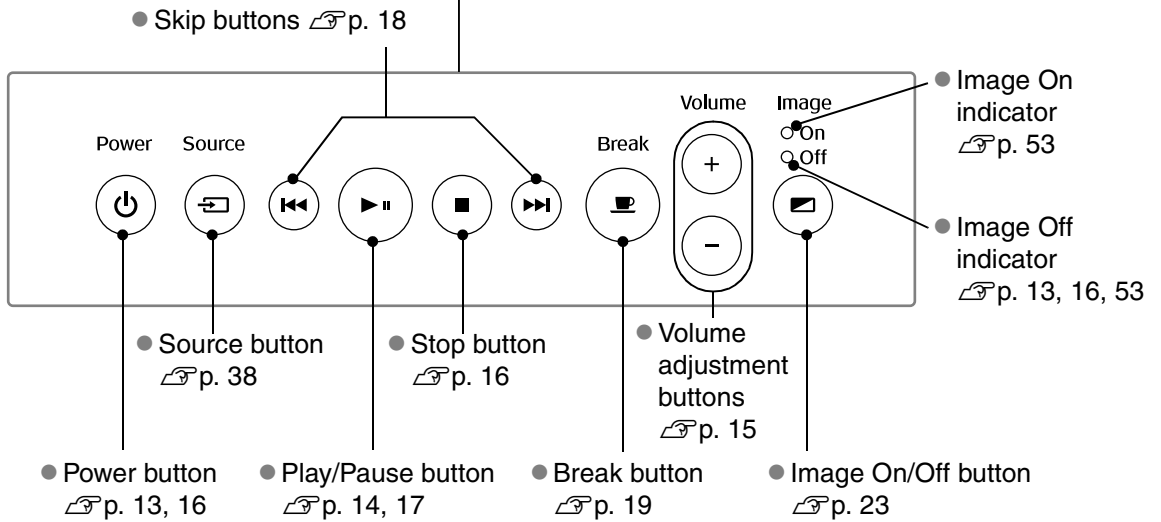
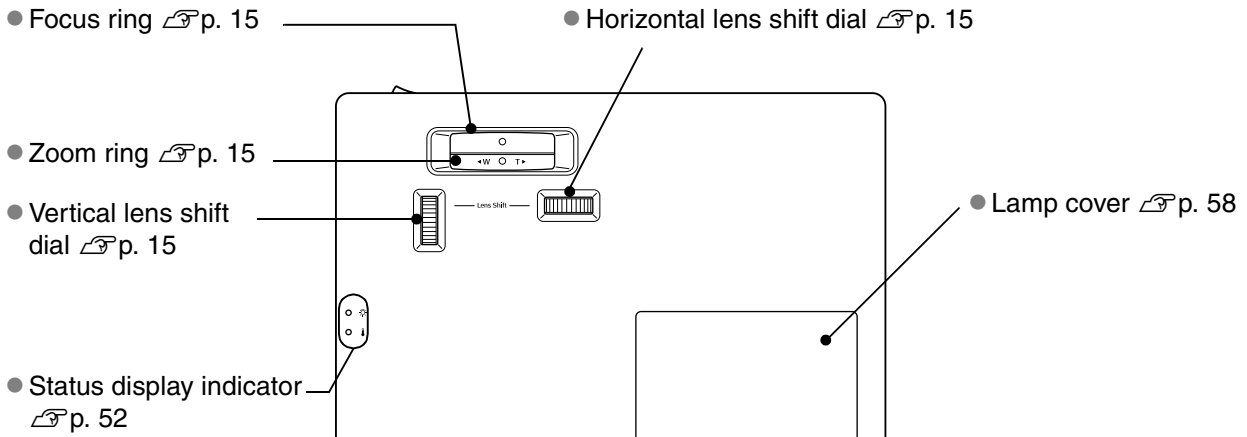

Remote control













● Remote control light-emitting area

● Function/numerics toggle switch p. 17, 21



Power  p. 16

Open/Close  p. 14

















Handy functions

On Screen  p. 34	Sleep  p. 35
Wide/Normal  p. 55	Color Mode  p. 19
Dimmer  p. 20	Repeat  p. 28
Sound Mode  p. 41	DVD Level  p. 42
Cancel  p. 48, 50	Play Mode  p. 30, 31
Progressive  p. 36	Playback  p. 18



Useful functions

Source  p. 38
Break  p. 19
Image On/Off  p. 23



Buttons used during playback

 p. 14, 16	 p. 17, 18
 p. 17	 p. 17
 p. 18	 p. 18
 p. 16	
Top Menu  p. 21, 22	Menu  p. 21, 22
Setup  p. 43	Return  p. 22, 44
Enter  p. 21	
    p. 21	





Buttons used when adjusting audio

Treble  p. 41	Volume  p. 15
Mute  p. 19	

Buttons used when adjusting DVD video

Audio  p. 32
Subtitle  p. 33
Angle  p. 33

Buttons used when adjusting or checking the projection

Visual Info.  p. 50
Visual Adjust  p. 48
  p. 48, 50

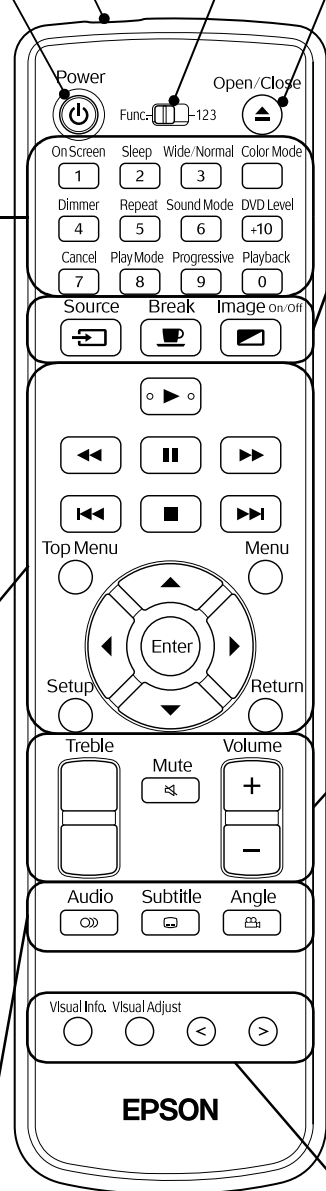

Preparing the Remote Control

Inserting the batteries

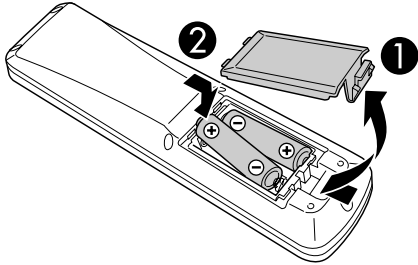

At the time of purchase, the batteries are not installed into the remote control. Insert the batteries provided with this unit, before use.

- 1** Push in the catch on the rear of the remote control, then lift it upwards.
- 2** Insert the batteries in their correct polarity.
- 3** Close the battery cover.



TIP

If delays in the responsiveness of the remote control occur, or if it does not operate after it has been used for some time, it probably means that the batteries are becoming flat. Replace the batteries. Have two spare AA-size (SUM-3) batteries ready to use when required.

Remote control usage range

Operable range (horizontal)

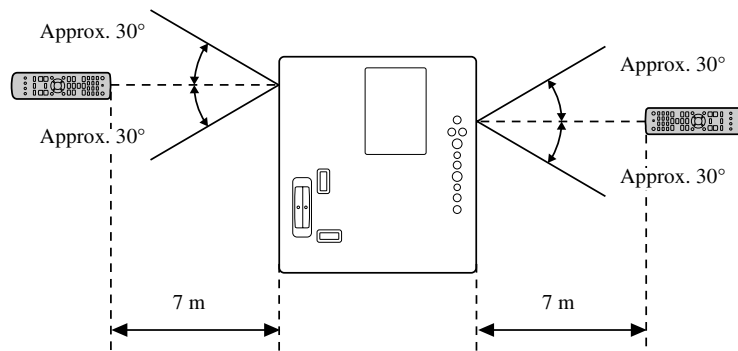

Operable range (vertical)

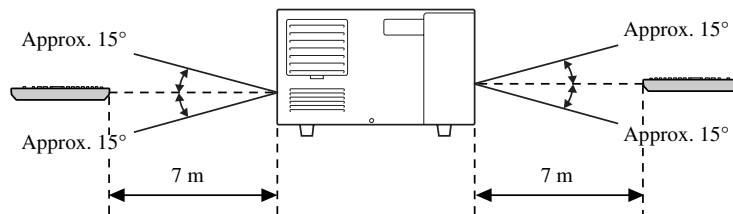

TIP

Avoid allowing direct sunlight or fluorescent light to fall on the remote control light-receiving area of this unit. The signal from the remote control may not be able to be received.

Quick Start

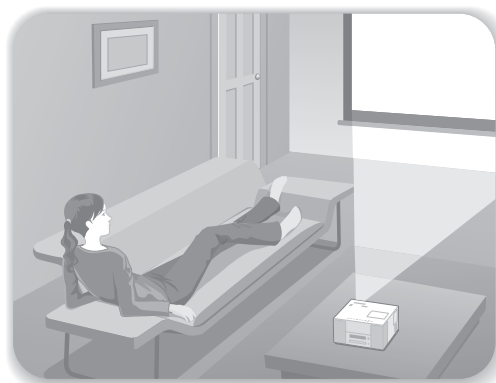
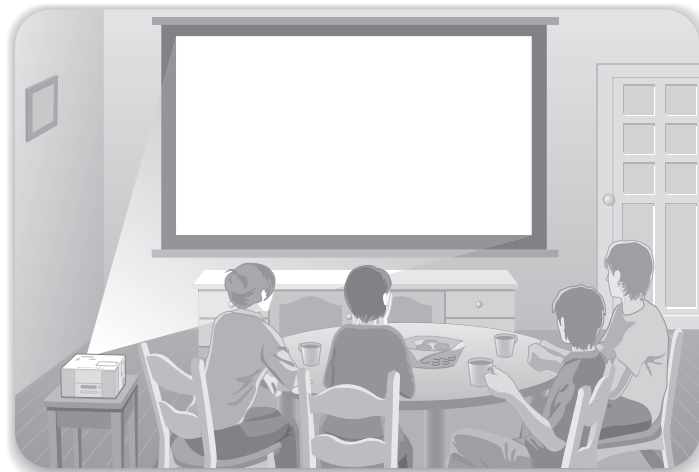

Playback procedure

No complicated connections are necessary. You don't even need to select the television type or change the input. You can enjoy your DVD's on the big screen by following these four easy steps.

There is also a JVC original sound system compliant speaker built-in so you can appreciate natural, sweeter sounding audio.

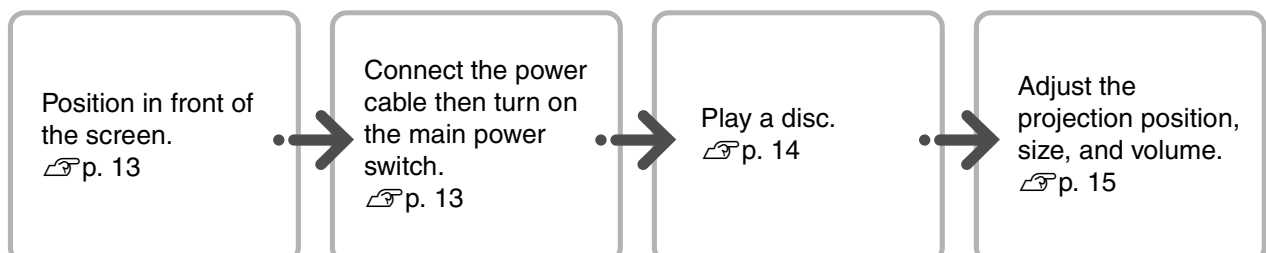

Installation

Projection distance and screen size

- 1 Place the unit in a position to project the best size image onto the screen.

The further this unit is moved away from the screen, the larger the projected image becomes.

For detailed projection distance values [p. 60](#)

You can adjust the position of the projected image vertically and horizontally, by using the lens shift dial. [p. 15](#)

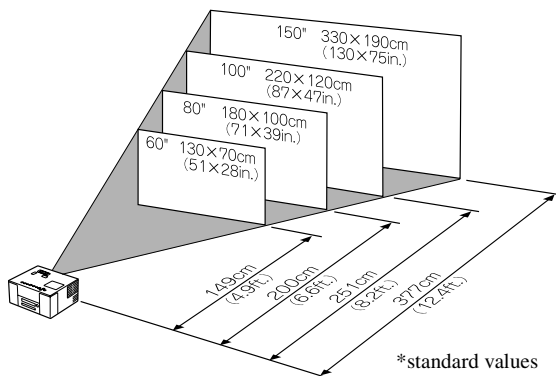

- 2 Position this unit so that it is parallel to the screen.

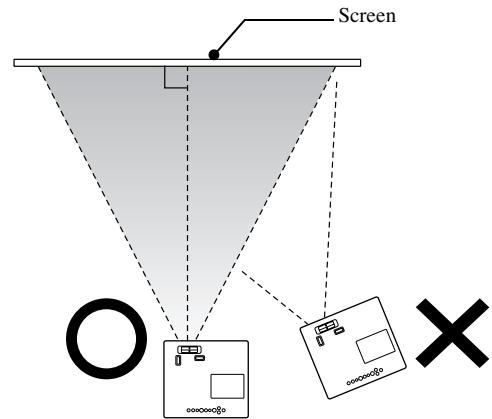

If this unit is not placed parallel to the screen, the projected image is distorted in the shape of a keystone.

Connecting the power cable and turning the main power switch ON

- 1 Remove the lens cover.

At the time of purchase, the lens cover is not attached to the projector.

- 3 Turn on the main power switch.

and the Image Off indicator lights orange.

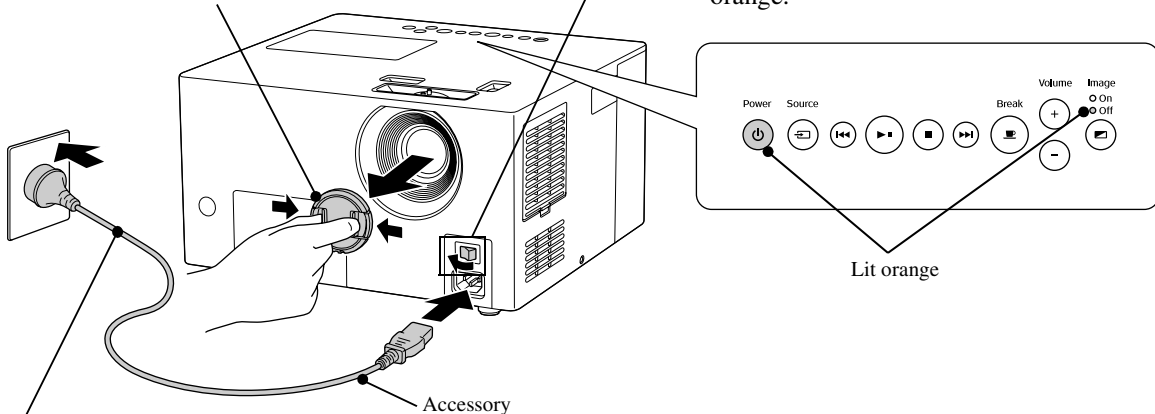

Lit orange

- 2 Connect the power cable.

Disc Playback

Playing a disc and projecting

DVD VIDEO VIDEO CD SVCD AUDIO CD MP3/WMA JPEG

- 1 Press  to open the disc tray.

A beep sounds and the power comes on.

The same operation can be performed using  on the remote control.



- 2 Place the disc in the disc tray with the label facing upwards.

When using 8 cm discs, place the disc in the hollow in the center of the disc tray.

- 3 Press  to close the disc tray.

Depending on the disc inserted, operation is as follows.

Excluding **AUDIO CD**: The projection lamp lights automatically, and projection begins. It takes a few seconds from when the lamp lights up until the projected image is brightly projected.

AUDIO CD: Press  to commence audio playback. The projection lamp does not light. The same operation can be performed using  on the remote control.

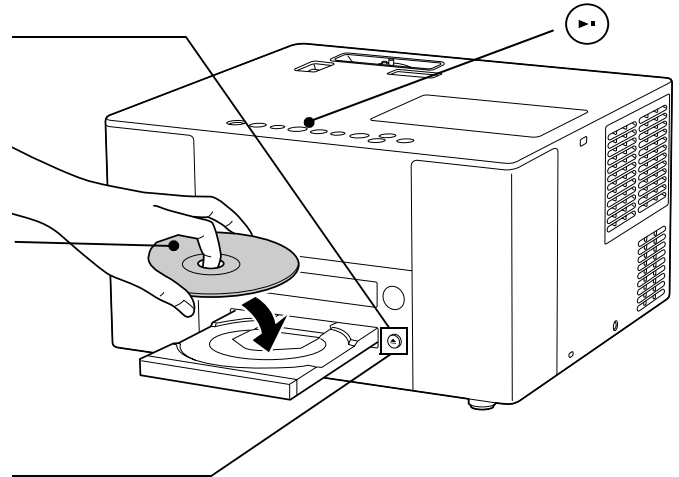

The display window during playback

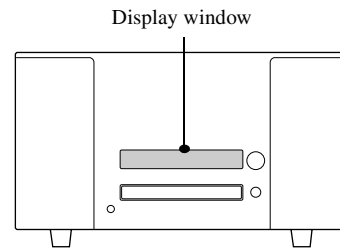

When playing **DVD VIDEO**

C 1 0:00:05

Chapter number Elapsed playback time

When playing **SVCD VIDEO CD**

VCD 1 PBC

Track number

When playing **AUDIO CD**

CD 1 0:05

Track number Elapsed playback time

When playing **MP3/WMA**

TR 1 00:05

Track number Elapsed playback time

When playing **JPEG**

JPG G 1F 1

Group number File number

When a menu is displayed

DVD VIDEO  p. 21

VIDEO CD SVCD  p. 22

MP3/WMA JPEG  p. 23



TIP When using in high altitude areas of above 1500 m, set the "High Altitude Mode" to "ON".  p. 51

Adjusting the projection position and volume

Adjust the volume and image being projected.

Adjusting the size of the projected image (Zoom ring)

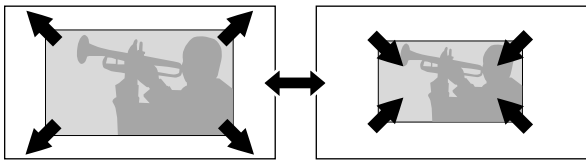

To decrease the size, turn towards "T".

To increase the size, turn towards "W".

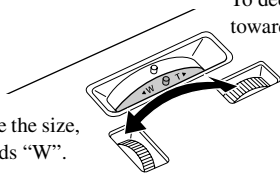

Setting the focus (Focus ring)

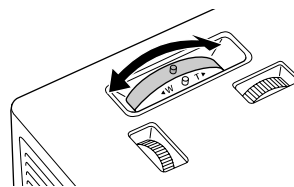
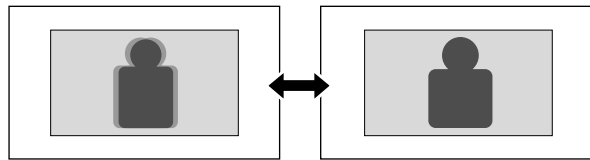

Adjusting the volume (Volume)

Using the control panel

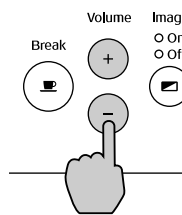

Using the remote control

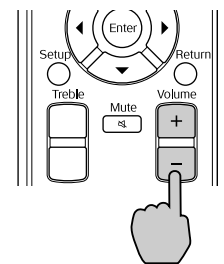

Adjusting the image position (lens shift)

You can move the position of the projected image up, down, left and right, using the lens shift. The range of movement is shown in the diagram on the right.

Standard projection position (when the lens shift dial is centered)

From the standard projection position the adjustable image shift range

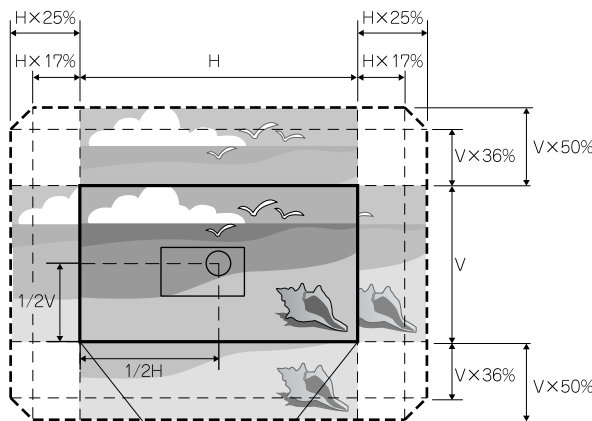

* The image cannot be shifted beyond the horizontal and vertical limits.

Example)

When shifting the maximum amount to the left or right on the horizontal plane, the vertical range of the shift is up to 36% of the height of the image.
When shifting the maximum amount up or down on the vertical plane, the horizontal range of the shift is up to 17% of the width of the image.

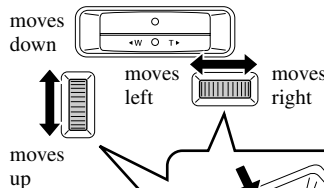

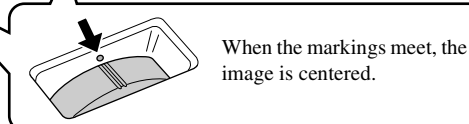

* The clearest image is obtained when both the horizontal and vertical planes of the lens shift dial are centered.

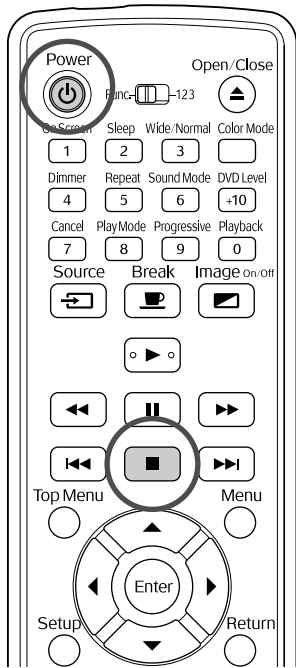



Turning off the power

- 1 Remove the disc from the disc tray.
- 2 Press .
- 3 If the lamp was on, the lamp turns off and the Image Off indicator on the main unit flashes orange (during cool-down).
“Now Cooling” is displayed in the display window.
- 4 The confirmation buzzer beeps twice to indicate that cool-down has completed. Turn off the main power switch.

If you only press  to turn off the power, electricity continues to be consumed.

- 5 Replace the lamp cover.

Keep the lens cover in place when the projector is not being used to protect the lens from dirt and damage.





Stopping playback



Press .

DVD VIDEO VIDEO CD SVCD After stopping, when you press , playback is resumed from the interrupted scene (resume).

Things to note when using resume

- Even if you press  and turn off the power, playback resumes when you press .
- Resume cannot be used in the following situations.
 - The disc is removed from the disc tray.
 - After pressing  to turn off the power and pressing  to turn the power back on.
 -  is pressed twice.
 - If the main power switch is turned off.
- Resume cannot be used during program playback or random playback.
- The position from where playback resumes may be slightly different to where playback was stopped.
- The audio language, subtitle language, and angle settings are memorized along with the stopping position.
- It is possible that resume cannot be used if the disc is stopped when the disc menu is displayed.



The Image Off indicator flashes orange to indicate that the internal lamp cooling function (cool-down) is taking place. The buttons on the remote control and the main unit are disabled when cool-down is taking place (approx. 9 seconds).

CAUTION

Do not turn off the power or unplug the unit during cool-down as this may reduce the lifespan of the lamp.

Basic Operations During Playback

From here on, operations are explained primarily using the buttons of the remote control. Where there is a button with the same marking on the main unit, that button can be used to the same effect.

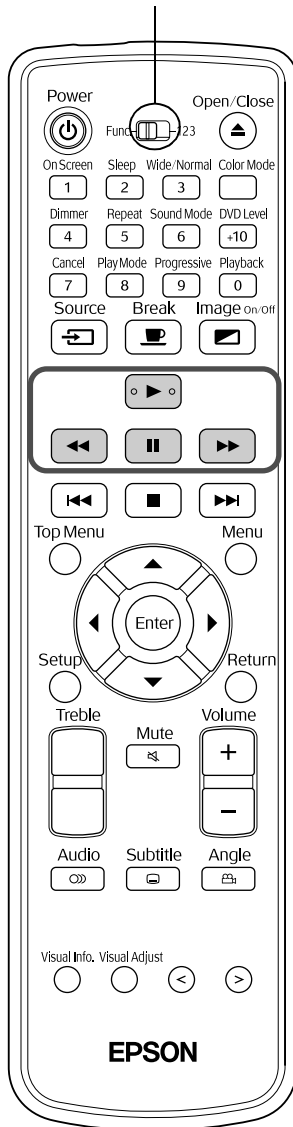

Set to the [Function] position before performing operations



Temporarily freezing playback (pause)

DVD VIDEO VIDEO CD SVCD AUDIO CD MP3/WMA JPEG



Press  during playback.

- For the projector unit, press .
- To resume playback, press .
- Selects play/pause each time you press .



Note the following points when pausing during a





JPEG slideshow.

- When you press  after pausing, playback restarts from the beginning of the next file.
- You cannot pause using  on the main unit.

Reverse search/forward search

DVD VIDEO VIDEO CD SVCD AUDIO CD

Press  or  during playback.

- There are five levels of reverse/forward search speed that change each time the buttons are pressed.
- Press  to return to normal playback.
- For the main unit, keep pressing  or . If you keep pressing  or  the reverse/forward search speed advances from 5x to 20x.



DVD VIDEO VIDEO CD SVCD During forward/reverse, sound is not output.

AUDIO CD During forward/reverse search, sound is output intermittently.

Set to the [Function] position before performing operations

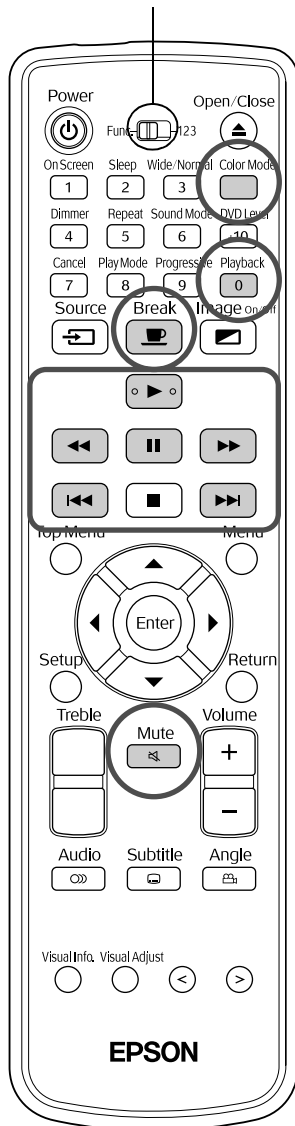

Reviewing playback from a position 10 seconds before

DVD VIDEO

Press during playback.



- Depending on the type of disc, this operation may not be possible.
- You cannot return to the previous title.

Skip

DVD VIDEO VIDEO CD SVCD AUDIO CD MP3/WMA JPEG

Press or during playback.

If you press once during chapter/track playback, playback returns to the start of the chapter or track being played. After this, playback returns to the start of the previous chapter/track each time you press (Except for **JPEG**). After this, playback returns to the start of the previous chapter/track each time you press .



- **DVD VIDEO** You can perform skip operations during playback.
- **VIDEO CD** **SVCD** You can only perform skip operations during playback with the PBC function off.
- **JPEG** You can also use the buttons to skip during playback.
- Depending on the disc, certain operations may not be possible.

Frame advance

DVD VIDEO VIDEO CD SVCD

Press during paused playback.





- A single frame is advanced each time you press . This unit does not have a frame return function.
- Press to return to normal playback.

Slow motion playback

DVD VIDEO VIDEO CD SVCD

1 Press  at the point where you want to begin slow motion playback. The image will pause.

2 Press .



- There are 5 levels of playback speed which change each time  is pressed.
- **DVD VIDEO** Slow motion review can be performed by pressing . There are 5 levels of review speed which change each time  is pressed.
- Press  to return to normal playback.
- Sound is not output during slow motion playback.

Temporarily using the projector light as illumination (Break)

DVD VIDEO VIDEO CD SVCD AUDIO CD MP3/WMA JPEG EXT. VIDEO

The break function is useful if, in the middle of a movie, you want to get up or move around carrying a drink, or some food, and so on. By simply pressing the  button you can pause the disc being played until you can get up to turn the lights on in the room.

Press  during playback.

- The projection lamp remains lit, whilst the projected image disappears.  flashes in the lower right of the screen.
- The lamp darkens after about five minutes if the projector is left in break mode without any operations being made. Additionally, when about 30 minutes have elapsed, the projector power automatically switches off.
- Press  to return to the state before break was pressed. If the power has switched off, press  to switch the power back on.



TIP

- Operations cannot be performed when the disc menu is displayed.
- When you press any of the following buttons, break mode is cancelled and the function of the button you pressed is performed.



Selecting a picture quality to suit the conditions of the room (Color Mode)

DVD VIDEO VIDEO CD SVCD AUDIO CD MP3/WMA JPEG EXT. VIDEO

You can select a picture quality to correspond to the brightness and other conditions of your room.

1 Press .

The currently selected color mode name is displayed on the screen.



2 While the color mode name is displayed, press  repeatedly until the desired color mode name appears.

After waiting a few seconds, the color mode name disappears and the picture quality changes.

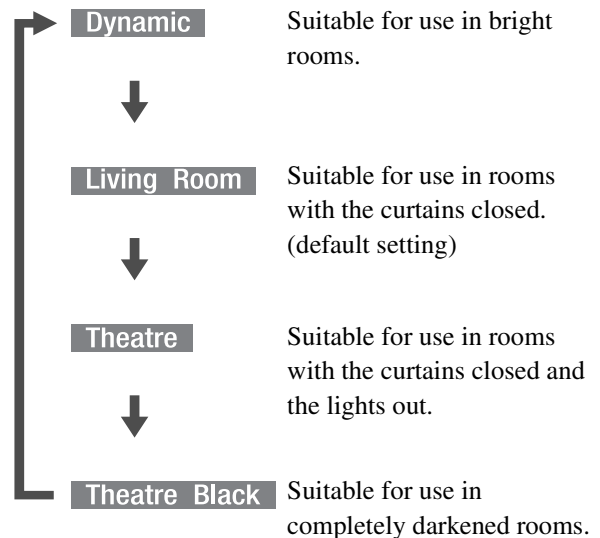

- When theater or theater black are selected, the EPSON cinema filter operates automatically and character's skin color takes on a more natural tone across the whole image.

Temporarily stopping the audio (Mute)

Press  during playback.

- Sound stops coming from the speakers, headphones, and the subwoofer.
- Press  to return to normal playback. The former volume is also restored when the projector power is next switched on,

Advanced Operations

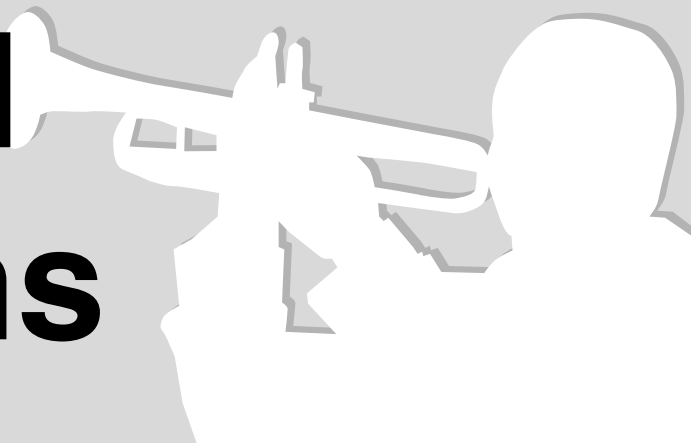

Becoming a playback expert

Changing the brightness of the display window (Dimmer)

Set to the [Function] position before performing operations

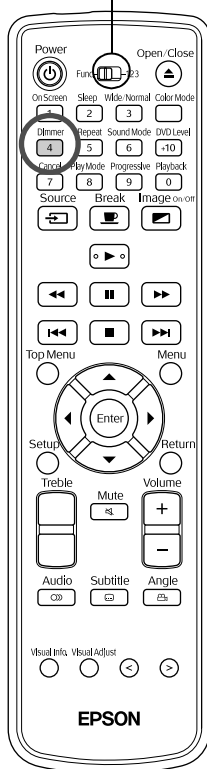

Press ^{Dimmer} 4 .

Whenever you press ^{Dimmer} 4 the display window display changes as follows. The brightness of the display window and the brightness of the indicators on the main unit change accordingly.

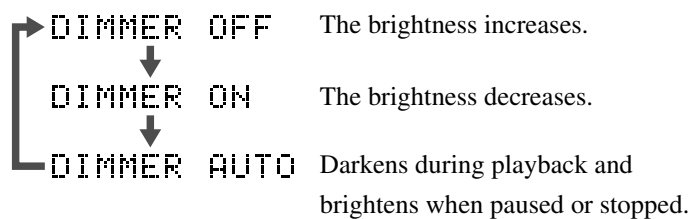

TIP

- When an **AUDIO CD** is inserted, this function is not available, even when “DIMMER AUTO” is set. It changes to “DIMMER OFF”.
- When in stand-by mode, the brightness cannot be changed, even if ^{Dimmer} 4 is pressed.
- Once the brightness is changed, it is remembered even after the main power switch is turned off.

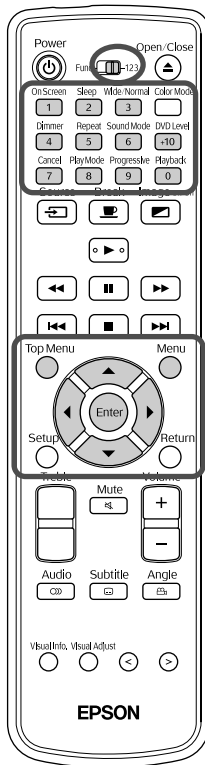

Some **DVD VIDEO** have the following kind of original menu saved onto them.

- **Top menu:** When multiple titles (image and audio) have been recorded, this integrated disc information is displayed.
- **Menu:** Title specific playback data (chapter, angle, audio, and subtitle menus) is displayed.

1 Press or during playback or when stopped.

2 Press and select the item you want to see.

You can also select the title number or chapter number directly using the numeric buttons.

When using the numeric buttons

With the function/numerics toggle switch in the [123] position, press the following buttons.

Example)

5: 10: →
 15: → 20: → →
 25: → →

Once you have finished entering numbers, return the function/numerics toggle switch back to the [Function] position.

3 Press .



- Certain discs may not contain a menu. If a menu is not recorded, these operations cannot be made.
- Depending on the disc, playback may begin automatically, even if is not pressed.

PBC (playback control) playback

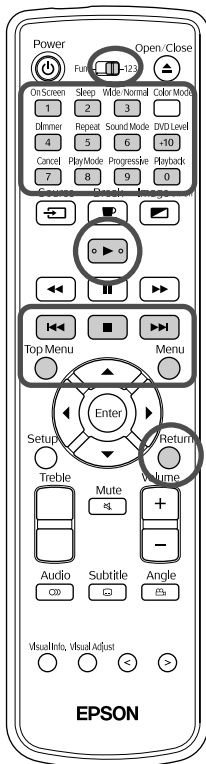

If a Video CD with “PBC (playback control) enabled” specified on the disc or jacket is inserted in the disc tray, a menu screen is displayed. You can select the scene or information you wish to see interactively from this menu.

- 1 When playing a Video CD that contains PBC, the following kind of menu is displayed.

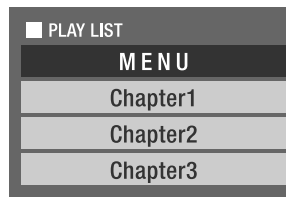

- 2 Select the item you want to see using the numeric buttons. [p. 21](#)

The selected contents are played.

To turn to the previous/next page of the menu screen

Press / when the menu screen is displayed.

To call the menu screen during playback

Each time is pressed, the menu goes back by one step. Press repeatedly until the menu is displayed.

To play without using the menu (playback without PBC)

Playback using either of the following methods.

- When stopped, specify the track number that you want to see using the numeric buttons.
- When stopped, select the track number using / then press .

Calling the menu screen when playing back without PBC

Press or .

After pressing twice to stop playback, press .

Set to the [Function] position before performing operations

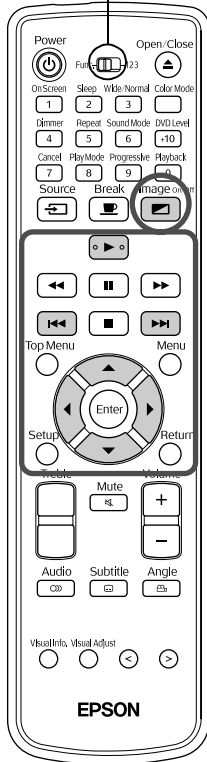

- 1 When playing back a disc that contains both MP3/WMA files and JPEG files, the following kind of group/track (file) name list is displayed.

FILE	PROGRAM REPEAT TRACK TIME
Group : XX / XXX	Track :XXX/XXXX (Total XXXX)
Group A	5. Track 5
Group B	6. Track 6
Group C	7. Track 7
Group D	8. Track 8
Group E	9. Track 9
Track Information	10. Track 10
Title	11. Track 11
XXXXXXXXXXXXXXXX	12. Track 12
Artist	13. Track 13
XXXXXXXXXXXXXXXX	14. Track 14
Album	15. Track 15
XXXXXXXXXXXXXXXX	16. Track 16

- 2 Press and select the group.
- 3 When you press the pointer moves to the track (file) name list. When you press the pointer returns to the group name list.

- 4 Press and select the track.

You can also make the same selection using .

- 5 Press or to begin playback.

When you press for a **JPEG**, continuous playback begins from the selected file (slideshow playback*). When you press , only the selected file is played.

- * During slideshow playback, each file is displayed for approximately 3 seconds then the next file is displayed. Once playback of all files is completed, the slideshow stops automatically.
- Track selection can also be made by entering the track number with the numeric keys. In this case, steps 3-5 are unnecessary.



TIP

When playing back a disc on which a mixture of different file types (MP3/WMA files and JPEG files) has been saved, select the file type to be played from the "FILE TYPE" PICTURE settings menu. p. 44

When playing MP3/WMA audio (Image Off)

Once menu selection is complete and the audio begins, press . This unit beeps and the projection lamp turns off so you can enjoy just the music being played.

Press to turn the lamp back on. Once the lamp has been turned off and when the Image Off indicator is flashing orange, the lamp does not come back on even if you press . Wait until the Image Off indicator goes out.

Set to the [Function] position before performing operations

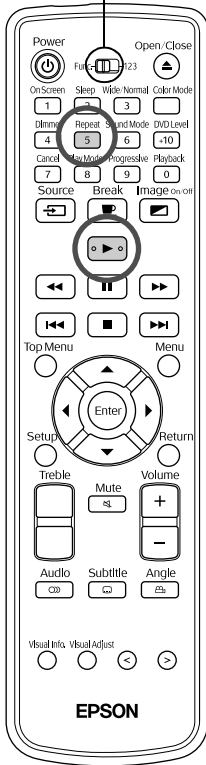

When you want to repeat playback

1 Press ^{Repeat} **5** during playback or when stopped.

Each time you press ^{Repeat} **5**, the repeat mode changes as shown in the following table.

2 Press .

Repeat play position

Repeat mode	Disc				Screen display	Display window display
	Group 1		Group 2			
	Track 1	Track 2	Track A	Track B		
Track repeat*					REPEAT TRACK	
Group repeat					REPEAT GROUP	
Disc repeat					REPEAT ALL	
Repeat OFF					not displayed	not displayed

*MP3/WMA files only

When MP3/WMA files are recorded on the disc, repeat play can be performed even during program play and random play.

Repeat mode	Screen display	Display window display
Repeats the track chosen when repeat play was selected	REPEAT STEP	
Repeats all tracks set during program play, or repeats all tracks in random play	REPEAT ALL	
Repeat OFF	not displayed	not displayed

Notes on playback

- Depending on the recording and the characteristics of the disc it is possible that the disc may not be readable, or that reading the disc may take some time.
- The time it takes to read a disc differs depending on the number of groups or tracks (files) recorded on the disc.
- The order of the group/track (file) name list display and the order displayed on a PC screen may be different.
- When playing commercially available MP3 discs, it is possible that playback will be in a different order to the order described on the disc.
- It may take some time to play still pictures containing MP3 files. The time-elapsed is not displayed until playback has commenced. Further, there are times when an accurate elapsed time is not displayed, even once playback has commenced.
- It is possible that data that has been processed, edited, or saved using computer image editing software might not play.

Specifications of files that can be played

To playback a CD-R or CD-RW containing MP3/WMA or JPEG files with this unit, the contents of the disc must conform to the following criteria.

MP3/WMA

File system: ISO9660 level 1 or level 2

Discs that have been recorded in the packet write (UDF) format cannot be read.

Bitrate: MP3: 32 kbps - 320 kbps

WMA: 64 kbps - 160 kbps

Sampling frequency: 16 kHz, 22.05 kHz, 24 kHz, 32 kHz, 44.1 kHz, 48 kHz

Filename: Half width English characters only. Must bear the “.mp3” or “.wma” file extension. Distinction between upper and lowercase characters is not performed.

Group (folder) count: up to 99

Track (file) count: up to 1000

Other: It is possible to playback multi-session recorded discs.

This unit is not compatible with Multiple Bit Rate (MBR : a file that contains the same content encoded at several different bit rates).

JPEG

File system: ISO9660 level 1 or level 2

Discs that have been recorded in the packet write (UDF) format cannot be read.

Filename: Half width English characters only. Must bear the “.jpg” or “.jpeg” file extension. Distinction between upper and lowercase characters is not performed.

Total number of pixels: Images containing up to 8192 x 7680 pixels can be read.

However, because it takes time to reproduce files with a resolution exceeding 640 x 480 pixels, it is recommended that images be saved at 640 x 480 pixels.

Group (folder) count: up to 99

Track (file) count: up to 1000

Other: It is possible to playback multi-session recorded discs.

Only baseline JPEG is supported.

Monochrome JPEG files cannot be read.

Progressive JPEG and motion JPEG are not supported.

JPEG data created by a digital camera and conforming to the DCF (Design rule for Camera File system) standard is supported. When certain digital camera functions such as automatic rotation have been used, it is likely that the data will not comply to the DCF standard. If this is the case, playback may not be possible.

Playback by selecting the chapter or track number



During playback, select the chapter or track number you wish to play by pressing the numeric buttons.

“When using the numeric buttons” p. 21



TIP

- **VIDEO CD** **SVCD** Can be used when stopped or when playing back with PBC off.
- **AUDIO CD** **MP3/WMA** **JPEG** Can also be used when stopped.
- Depending on the disc, certain operations may not be possible.

Designated time playback (time search)

DVD VIDEO VIDEO CD SVCD AUDIO CD

Set to the [Function] position before performing operations

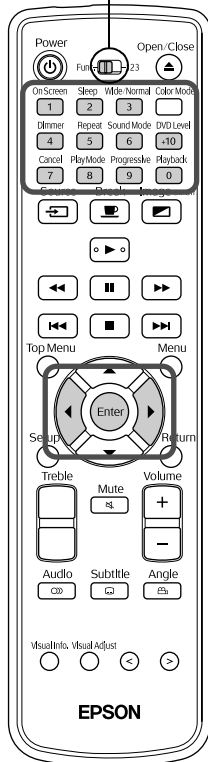

You can playback from a specified time position. Depending on the disc, the start point position varies as follows.

DVD VIDEO Time elapsed from the start of the title

VIDEO CD **SVCD** **AUDIO CD** When executing from stopped: Time elapsed from the start of the disc

When executing during playback: Elapsed time from the start of the current track being played

1 Press **OnScreen** **1** twice during playback or when stopped.

The following menu bar is projected.



- **DVD VIDEO** This function can only be used during playback.
- **VIDEO CD** **SVCD** Cannot be used when playing back using the PBC function.

2 Press **Left Arrow** **Right Arrow** until the pointer reaches **TIME**.

3 Press **Enter**.

4 Enter the time using the numeric buttons.

- **DVD VIDEO** The start position is specified in hours/minutes/seconds. You can leave out the minutes/seconds if desired.
- **VIDEO CD** **SVCD** **AUDIO CD** The start position is specified in minutes/seconds.

Entering the time

Example)

To playback from 0 hours, 23 minutes, and 45 seconds

Set the Function/Numerics toggle switch to the [123] position.

Press the numeric buttons in the order of **0** → **2** → **3** →

4 → **5**.

If you make a mistake, press **Left Arrow** and delete the incorrect number, then re-enter the correct number.

Once you have finished entering the time, return the function/numerics toggle switch back to the [Function] position.

5 Press **Enter**.

6 Press ^{OnScreen} **1** once and the menu bar disappears.



TIP

- If the elapsed time is not displayed in the display window during playback with **DVD VIDEO**, this function will not work.
- **DVD VIDEO** It is also possible that some discs may prohibit time searching.
- The status bar is not displayed when playing back cinemascope (letterbox) **DVD VIDEO**. Although functions can be set in this state, when it is necessary to display the status bar, press ^{Wide/Normal} **3** to return the aspect ratio to normal. Press ^{Wide/Normal} **3** to return to the former aspect ratio.
- When playing back in program play or random play modes, this function will not work.

Looping playback of a favorite scene (A-B repeat playback)



Set to the [Function] position before performing operations

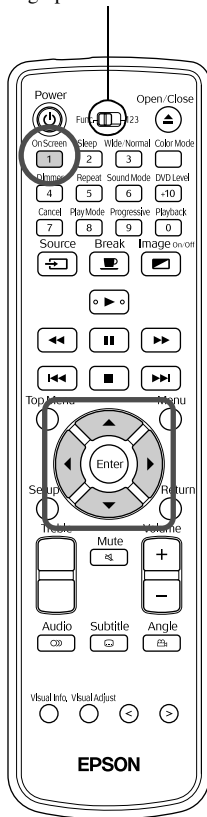

Set the playback range (start point to end point) from the menu bar during playback.

1 Press ^{OnScreen} **1** twice during playback.
The following menu bar is projected.



- **DVD VIDEO** Where possible, this function can be used during playback.
- **VIDEO CD** **SVCD** Cannot be used when playing back using the PBC function.

2 Press until the pointer reaches **OFF**.

3 Press **Enter**.

4 Press then select **A-B**.

You can also select other repeat modes from here. Other repeat modes
 p. 28

5 When you reach the scene or track to be the starting point of the loop range, press **Enter**.

The menu bar icon changes to **A-**.



6 When you reach the scene or track to be the end point of the loop range, press **Enter**.

The menu bar icon changes to **A-B** and **A-B** is displayed in the display window of the main unit. A to B playback begins.

7 Press  once and the menu bar disappears.



To cancel A to B playback

To cancel A to B playback, do one of the following operations.

- Display the menu bar, select  then press  twice.
- Press .
- Turn off the power switch on the main unit.



TIP

- You cannot specify a range which includes multiple titles or tracks.
- “A-B repeat” cannot be performed at the following times.
 - During program play
 - During random play
 - During repeat play
 - During PBC
- The status bar is not displayed when playing back cinemascop (letterbox) **DVD VIDEO**. Although functions can be set in this state, when it is necessary to display the status bar, press  to return the aspect ratio to normal. Press  to return to the former aspect ratio.

Looping playback (repeat play)

DVD VIDEO **VIDEO CD** **SVCD** **AUDIO CD**

Set to the [Function] position before performing operations

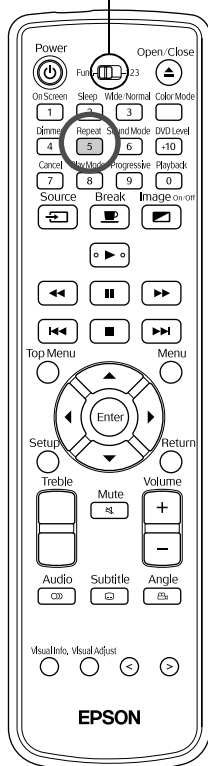

Depending on the type of disc, you can loop playback within a range of titles, chapters, or tracks, as in the following table.

Press  during playback.







The repeat mode changes whenever you press  and the repeat mode name and icon are displayed on the projected screen and in the display window.

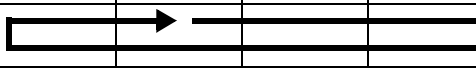

- **DVD VIDEO** Where possible, this function can be used during playback.
- **VIDEO CD** **SVCD** Cannot be used when playing back using the PBC function.

DVD VIDEO

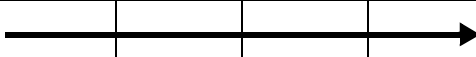
Repeat play position

Repeat mode	Title				Screen display	Display window display
	Chapter 1	Chapter 2	Chapter 3	Chapter 4		
Chapter repeat						
Title repeat						
Repeat OFF						not displayed

Repeat mode	Track 1	Track 2	Track 3	Track 4	Screen display	Display window display
Track repeat						
Repeat all tracks						
Repeat OFF						not displayed

Canceling repeat play

- Press repeatedly until “OFF” is displayed on the screen.
- Turn off the power switch on the main unit.



TIP

- **DVD VIDEO** You cannot use the “Title repeat” function with some DVDs.
- **DVD VIDEO** To cancel repeat, press .
- Display the menu bar and move the pointer to to select repeat play. p. 34

Repeat modes available during program play and random play

Repeat mode	Screen display	Display window display
Repeats the chapter/track designated when repeat play was selected		
Repeats all tracks set during program play, or repeats all tracks in random play		
Repeat OFF		not displayed

Playing in the order of your choice (program play)



Set to the [Function] position before performing operations

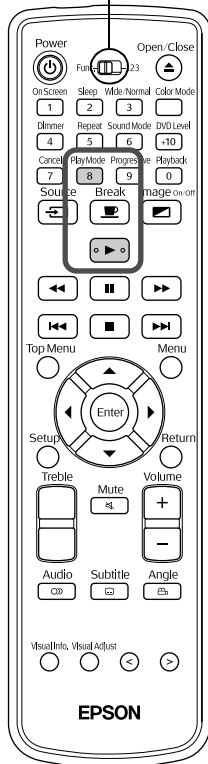

You can set titles, chapters, and tracks to playback in the order of your preference.

1 Press **PlayMode 8** when stopped.

Each time you press **PlayMode 8**, the display window on the main unit changes as follows. Press repeatedly until “PRGM” is displayed.

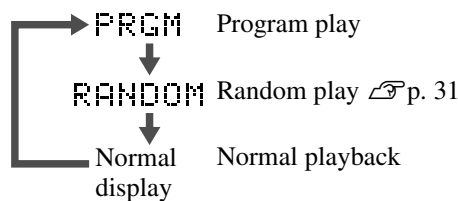

2 Set the order according to the following screen explanations.

☞ “When using the numeric buttons” p. 21

3 Press **Play**.

- Playback begins according to the order you set.
- Once the set playback is fully complete, playback ceases and “Program” is displayed.

Canceling set items on the program screen individually

Set numbers are deleted one by one each time **Cancel 7** is pressed.

Canceling all set items on the program screen

Press **Stop**.

Also cancelled when the power to this unit is switched off.

Resuming normal playback

When stopped, press **PlayMode 8** repeatedly until the display window of the main unit returns to its normal display state.

In this case, the contents entered in the program screen remain in memory. Program play can be executed by pressing **PlayMode 8** again and selecting “PRGM”.



- A maximum of 99 titles, chapters or tracks can be selected. If you try to enter more than 99, “FULL” is displayed.
- **AUDIO CD VIDEO CD SVCD** If the total of the set playback time exceeds 9 hours, 59 minutes and 59 seconds, “--:--” is displayed in the display window of the main unit, however, you can continue to perform the set order as it is.
- **DVD VIDEO** If you press **Enter**, instead of setting the chapter or track number, “ALL” is displayed and all of the chapters and tracks contained in that title/group are set.
- If stopped during program play mode, resume play cannot be used.
- Depending on the type of disc, you may not be able to use program play.

Playback at random (random play)

DVD VIDEO VIDEO CD SVCD AUDIO CD MP3/WMA

Set to the [Function] position before performing operations

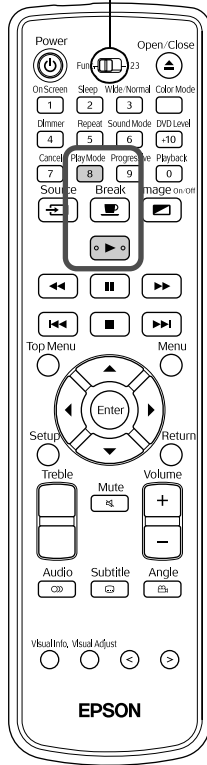

You can choose to play titles or chapters/tracks at random with this unit. The playback order always changes when using random play.

1 Press **PlayMode** **8** when stopped.

Whenever you press **PlayMode** **8** the display window display changes in the following way. Keep pressing until “RANDOM” is displayed.

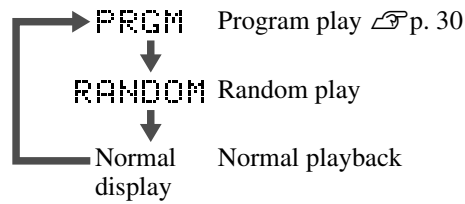

2 Press **Play**.

Once one title or track has finished, another title or track is played randomly.

Resuming normal playback

When stopped, press **PlayMode** **8** repeatedly until the display window of the main unit returns to its normal display state.



TIP

- Random play is cancelled if the following operations are performed.
 - The disc tray is opened.
 - Power to this unit is switched off.
- Even if you press **Play** repeatedly during random play, you cannot skip to the previously played content. It only returns to the start of the current chapter/track.
- If stopped during random play mode, resume play cannot be used.

Changing the audio language

DVD VIDEO VIDEO CD SVCD

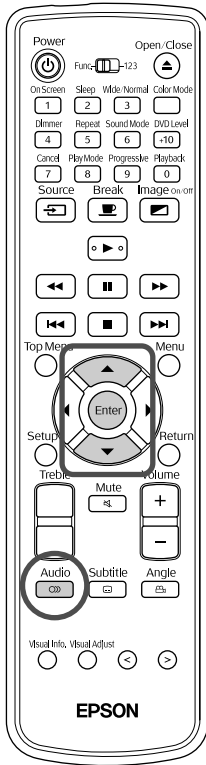

When a disc has been recorded with multiple audio signals or languages, you can switch to the available audio signal or language of your preference.

1 Press **Audio** during playback.

The current audio settings are displayed.



2 While the audio settings are displayed, press **Audio** repeatedly and select the desired setting.

Press to change the setting.

3 Wait a few seconds, or press **Enter**.



TIP

- You can also use the menu bar to change the setting. [p. 34](#)
- If a language code (for example AA) is displayed [p. 46](#)
- **VIDEO CD** **SVCD** The meaning of the characters displayed during playback is as follows.
 - ST: Stereo
 - L: Left channel audio
 - R: Right channel audio

Changing the subtitles display

DVD VIDEO SVCD

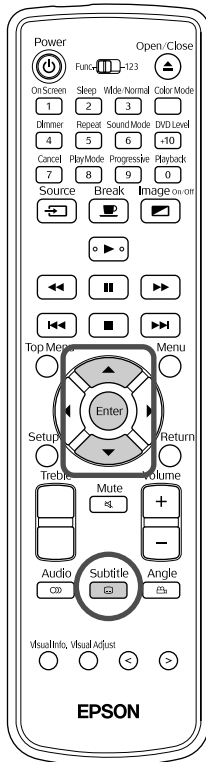





You can choose whether or not to display subtitles for discs that have been recorded with subtitles. When a disc has been recorded with multiple language subtitles, you can switch to the available language of your preference.

- 1 Press  during playback.

The current subtitle settings are displayed.



- 2 While the subtitle settings are displayed, press  repeatedly and select your language/OFF. Press   and select the subtitle language.

SVCD If you press  repeatedly, you can select the subtitle type and subtitles display on/off.

- 3 Wait a few seconds, or press .

Changing the angle

DVD VIDEO

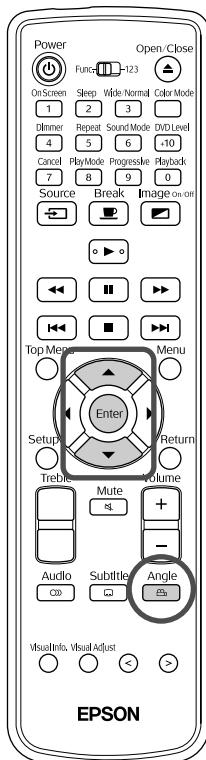



For discs that have been recorded with multiple camera angles, you can switch from the main angle to a different camera angle of your preference, such as from above, or from the right, during playback.

- 1 Press  during playback.

The current angle is displayed.



- 2 While the angle is displayed, press  repeatedly and select the desired angle.

Press   to change the setting.

- 3 Wait a few seconds, or press .

Making operations from the menu bar



Set to the [Function] position before performing operations

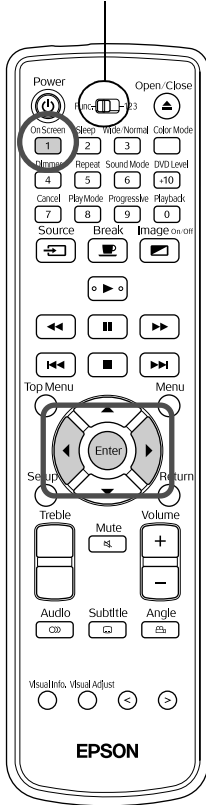

1 Press **OnScreen** **1** twice during playback.

The following status bar and menu bar is projected.



2 Press **Left/Right Arrow** until the pointer reaches the item you wish to use.

3 Press **Enter**.

- Press **OnScreen** **1** once and the menu bar disappears.
- When stopped, some functions may not work.
- The status bar is not displayed when playing back cinemascope (letterbox) **DVD VIDEO**. Although functions can be set in this state, when it is necessary to display the status bar, press **Wide/Normal** **3** to return the aspect ratio to normal. Press **Wide/Normal** **3** to return to the former aspect ratio.

Menu bar function list

OFF	Select the repeat mode. p. 28, 29
→	Set a time based start point. p. 26
CHAP. →	DVD VIDEO only. During playback, select the chapter number you wish to play using the numeric buttons. With the function/numerics toggle switch in the [123] position, enter the number in the following way. Example) 5: 5 10: 1 → 0 20: 2 → 0 If you make a mistake, enter the correct number once again. Press Enter .
1/1	Select the audio language/type. p. 32
1/1	Select to change the subtitles display. p. 33
1/1	Select the angle. p. 33

Auto-standby, goodnight timer (Sleep timer) settings



Set to the [Function] position before performing operations

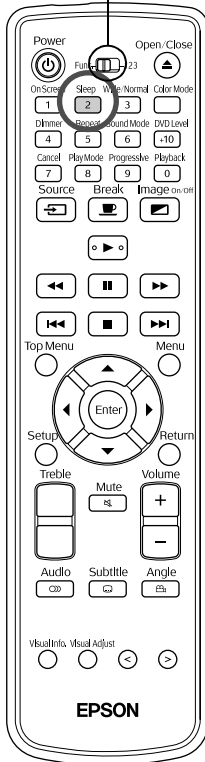

Auto stand-by: When playback has finished or been stopped, or an operation has not been performed for around 3 minutes, the power switches off automatically.

Sleep timer: Once the set time has elapsed, the power switches off automatically. You can prevent unnecessary power being consumed if you fall asleep while watching a movie.

You cannot use auto stand-by and sleep timer at the same time.

Press .

- Each time you press , the display window display changes as follows. Press repeatedly until the desired item is displayed.

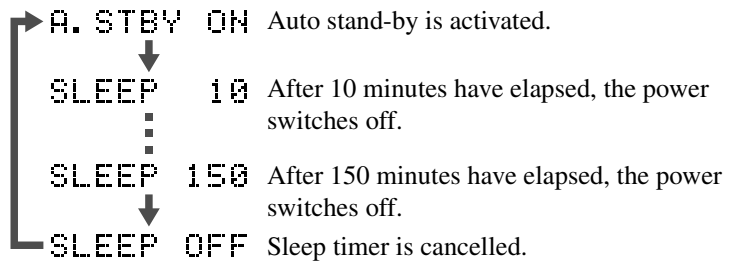

- If you select something other than “A.STBY ON”, auto stand-by is cancelled.

Setting auto stand-by

“A.STBY” flashes approximately 20 seconds before the power switches off.

Changing the sleep timer

Press  repeatedly and select the new time.

Checking the sleep timer setting

Once the sleep timer has been set, if you press  once, the set time is displayed in the display window.

Canceling the sleep timer

Perform either of the following operations.

Press .

Press  repeatedly until “SLEEP OFF” is displayed in the display window.



- Sleep timer settings are not memorized. If the power is switched off, the sleep timer is canceled.
- When in external video mode, video is switched off automatically if no signal is input and no operations are performed for 30 minutes. This function is performed regardless of the sleep timer settings.
- Auto stand-by cannot be used when in external video mode.
- Auto stand-by does not work with discs that return to the menu once playback has completed.

For better image quality (Progressive mode)

DVD
VIDEO

Set to the [Function] position before performing operations

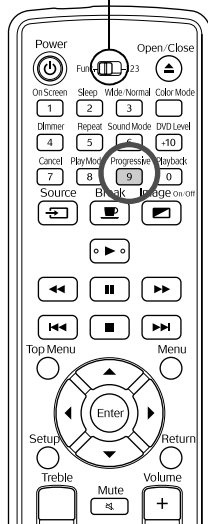

To enjoy clearer images, enable Progressive mode.

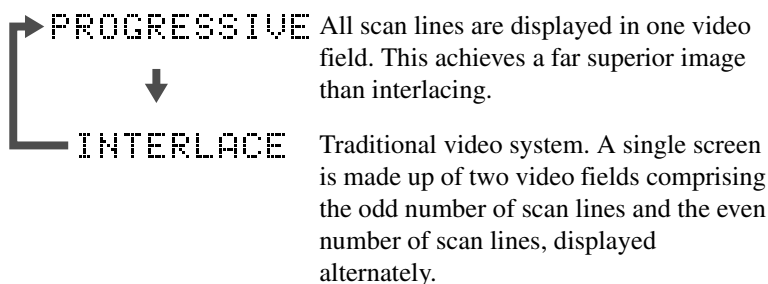

When stopped, or when there is no disc loaded in the disc tray, press ^{Progressive} 9 .

Whenever you press ^{Progressive} 9 the display window display changes in the following way. Press until “PROGRESSIVE” is displayed.



Tray lock

You can lock the disc tray so that small children cannot interfere with it. The disc lock allows you to lock the tray when a disc has been inserted.

With the power turned on (( is lit green) press and hold  on the main unit, then press .

- “LOCKED” is displayed in the display window on the main unit, and the disc tray is locked.
- To cancel the disc lock, follow the same procedure. “UNLOCKED” is displayed in the display window on the main unit, and the disc tray becomes unlocked.

Becoming a Projection Expert

Connecting to other video equipment

Aside from the built-in DVD player, this unit can project images by connecting to the following kind of equipment with a video output port.

- Video recorder
- Game machine
- Video camera and so on

When the video equipment you are connecting conforms to both the S-Video format and the composite video format, you can enjoy higher quality images by connecting with S-Video.

The composite video format, is also simply referred to as "Video Out".



TIP If the equipment you are connecting has a unique connector shape, connect using the cable that came with your equipment, or an optional cable.

CAUTION

- Turn off connected equipment. Damage may result if you try to connect when the power is on.
- Do not try to force a cable connector to fit a port with a different shape. This may damage the unit or the equipment.
- Close the interface cover when you are not connecting to external video equipment.

Composite video format

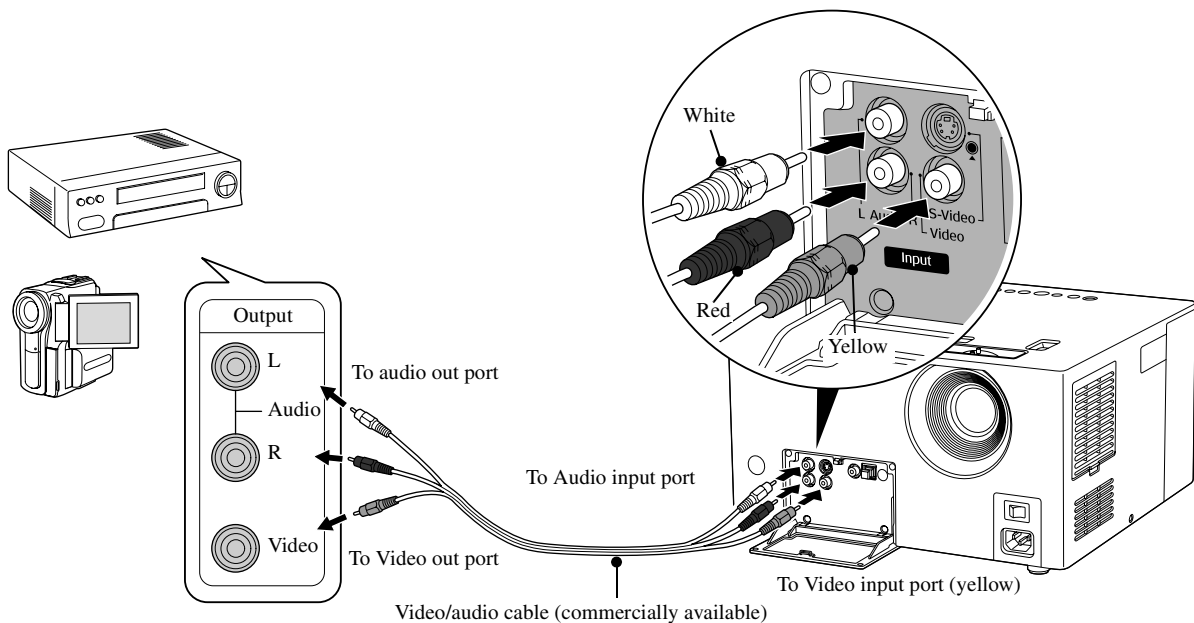

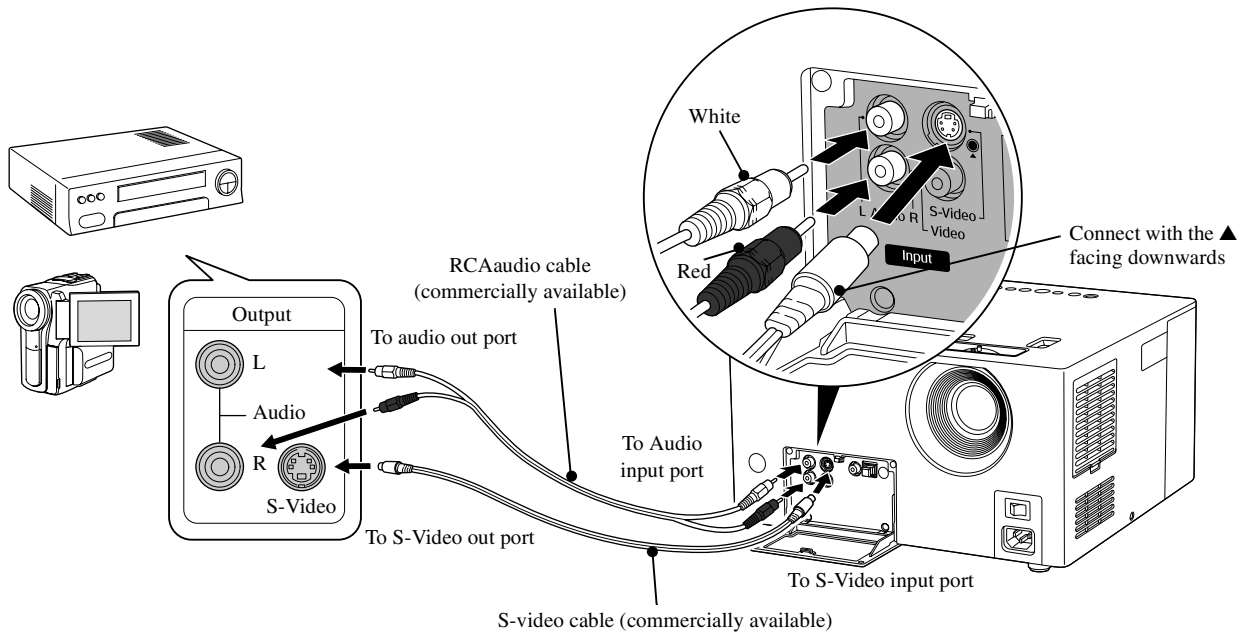

S-Video format

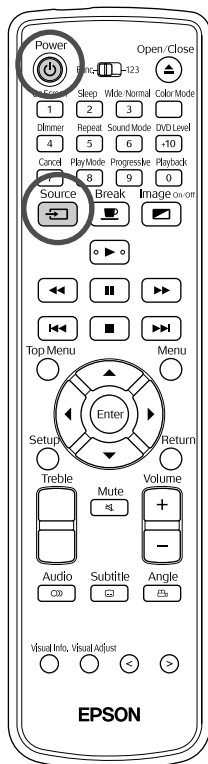

Projecting images from external video equipment



- 1 Remove the lens cover if it is in place.
- 2 Turn on the power switch on the main unit then press .
- 3 Press .

"VIDEO" is displayed in the display window and this unit switches to external video mode.
- 4 Switch on the power to the connected video equipment then start playback.

If the lamp was off, it comes on.













After a moment, the image is projected.

To return to the standard built-in DVD player

Press . "DVD/CD" is displayed in the display window and this unit switches back to DVD mode.

Functions available when in external video mode

The functions available when in external video mode are as follows.

- Color Mode  p. 19
- Sound Mode  p. 41
- Image On/Off  p. 23
- Volume  p. 15
- Select button  p. 48, 50
- Wide/Normal  p. 55
- DVD level  p. 42
- Adjusting high pitched tones  p. 41
- Information  p. 50
- Sleep  p. 35
- Break  p. 19
- Mute  p. 19
- Picture Quality  p. 48

Becoming an Audio Expert

Listening with headphones

CAUTION

- When listening with headphones, make sure the volume is not too high. You may affect your hearing in an adverse way when listening to sounds at high volume over an extended period of time.
- Don't set the volume too high from the outset. A loud sound may be produced suddenly that may cause damage to your headphones or your hearing. As a precaution, lower the volume before you switch off this unit then raise it gradually after you switch it back on.

Connecting commercially available headphones.

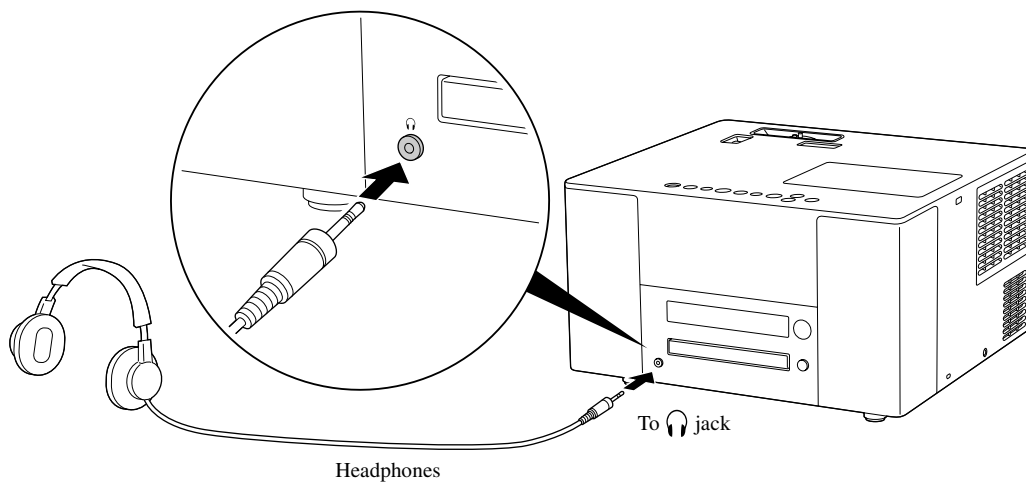

Once you have connected your headphones to the headphone jack, sound does not come from the speakers. When connected to a subwoofer, sound also stops coming from the subwoofer.

Connecting to audio equipment with an optical digital input

You can connect to AV amplifiers and equipment capable of making digital recordings (MD recorders, and so-on) when they are equipped with a digital audio input port. When connecting, use a commercially available optical digital audio cable.

When connecting the cable, remove the cap, align the shape, and insert firmly. Apply the cap when not in use to prevent dust from entering the port.

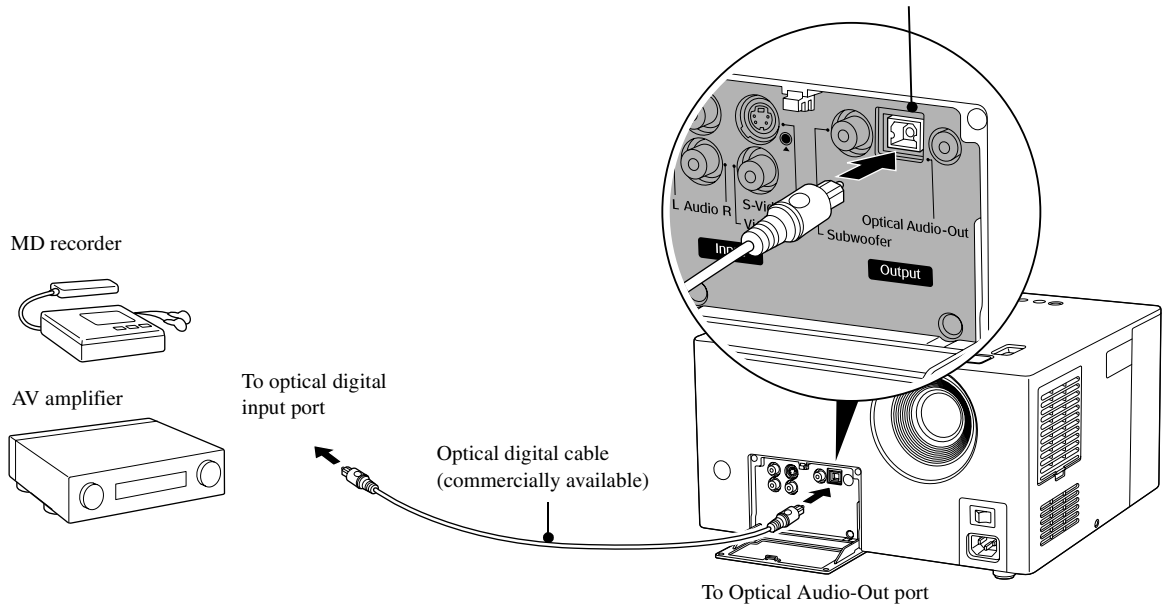

- The signal being output from the Optical Audio-Out port is changed with the “DIGITAL AUDIO OUTPUT” setting in the settings menu. For detailed output signal information [↗](#) p. 46
- The settings menu “D. RANGE COMPRESSION” setting is invalid when connecting to an amplifier with a built-in Dolby Digital decoder. [↗](#) p. 45

Connecting a subwoofer

You can enjoy richer more powerful bass, by connecting to the optional subwoofer.

For connection and usage instructions, refer to the “User’s Guide” provided with your subwoofer.

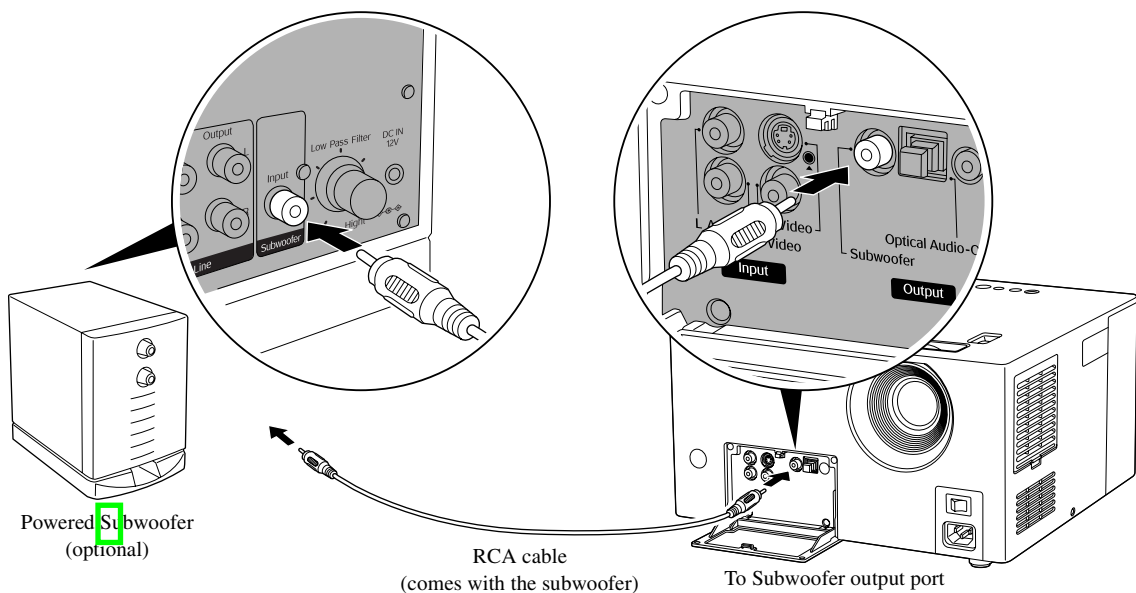

Selecting Sound Mode

Set to the [Function] position before performing operations

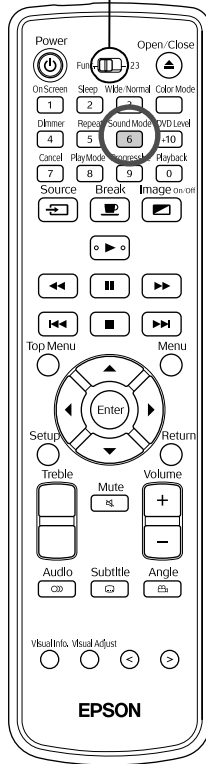

You can obtain broader more natural audio from the speakers of this unit by activating the JVC original sound system function.

Press **Sound Mode** **6**.

Each time you press **Sound Mode** **6**, the display window display changes as follows. Press **Sound Mode** **6** repeatedly until the desired mode name is displayed.

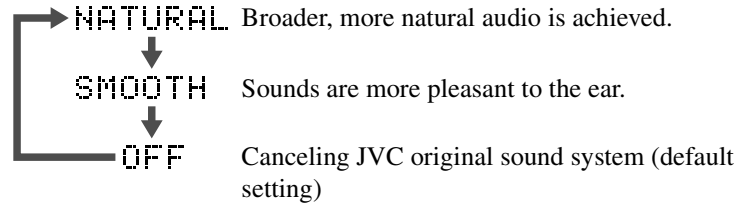

About JVC original sound system

Alpha waves are said to be the brain waves which are generated when a person is relaxing. JVC original sound system is the alpha wave frequency fluctuation given to the necessary variation between the left and right signals in a sound circuit (the indirect sounds between L-R). This is called LFO modulation. The aim is to correct the audio signal to fall easily within this median region, to produce natural sounding audio that relaxes you simply by listening to it.

Adjusting high pitched tones

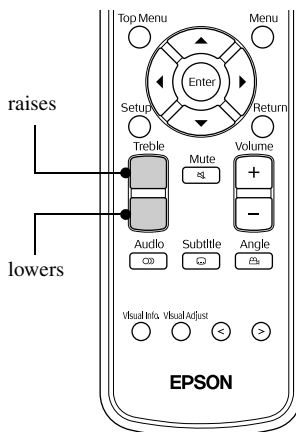

Adjusts the volume of high pitched tones.

Available when audio is being input from external video equipment.

Adjusting the audio playback level

DVD VIDEO

Set to the [Function] position before performing operations

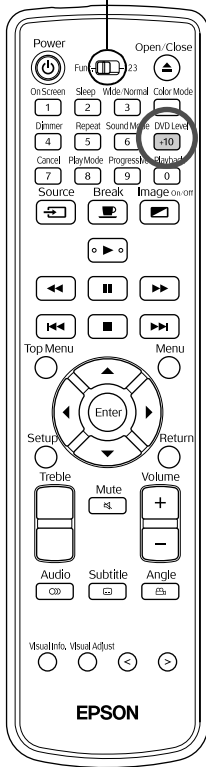

The audio of a DVD video may be recorded at a level (volume) which is lower than other kinds of disc. The unit's default setting recognises and plays DVDs at a higher volume. Make the following settings if this difference bothers you.

Press **DVD Level** **+10** during playback.

Each time you press **DVD Level** **+10**, the display window display changes as follows. As you listen to the audio being played, press repeatedly until the setting you want is displayed.

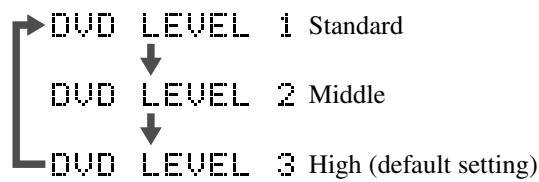

- The setting is only effective when **DVD VIDEO** is played. Even if this setting is changed, the output level from the Optical Audio-Out port does not change.
- This operation can also be performed when stopped or paused.

Adjusting the audio input level of external audio equipment

EXT. VIDEO

Set to the [Function] position before performing operations

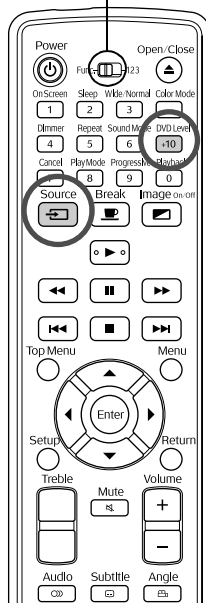

You can adjust the audio input level of equipment connected to the Audio port.

1 Press **Source** and switch to the external video mode.



2 Press and hold **DVD Level** **+10** for approximately 2 seconds.

Each time you press and hold **DVD Level** **+10**, the display window display changes as follows.

LEVEL 1 For normal use (default setting)



LEVEL 2 Use this setting when the input level from external equipment is too low and the audio is difficult to hear.

Settings and Adjustments

Settings Menu Operation and Functions

The settings of this unit can be adjusted to suit the environment in which it is used.

Using the settings menu

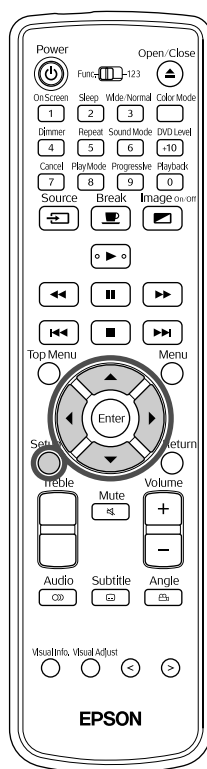



You can select your language from the “ON SCREEN LANGUAGE” list.

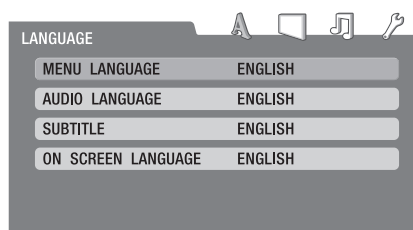

- 1 When stopped, or when there is no disc loaded in the disc tray, press .

The following settings menu is displayed.



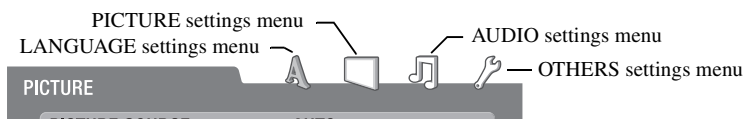

- 2 When you press   the pointer moves to the icons at the top right, from where you can select the menu group.



- 3 Press   and select the item to be set.

- 4 When you press  the setting contents are displayed in a pull-down menu.

5 Press   and select the item, then press .

When in a settings menu, to return to the previous state by one step,

Press .

Settings menu list

Boldface is the default.

LANGUAGE settings menu

Setting Item	Setting Contents
MENU LANGUAGE Select the language for the DVD video menu.	For “AA” and other language codes, see the “Language code list”. ℓp. 46
AUDIO LANGUAGE Select the language for the DVD video soundtrack.	These settings become available when settings have been recorded on the disc itself. When settings have not been recorded, the setting contents become available. If the language selected has not been recorded on the disc, the default language for that disc is used.
SUBTITLE Select the language for the DVD video subtitles.	
ON SCREEN LANGUAGE Select the language for displaying the menus (Settings, Picture Quality, Information).	

PICTURE settings menu

Setting Item	Setting Contents
PICTURE SOURCE	AUTO: The image source (video/film) is determined automatically. FILM: Suitable for film, or video images that have been recorded with the progressive scan method. VIDEO: Suitable for video images.
SCREEN SAVER Select whether or not to fade out the projected screen after a still picture has been displayed for around 5 minutes and no operation has been performed.	ON: Fades out. OFF: Does not fade.
FILE TYPE Select which format to play when a disc containing both MP3/WMA and JPEG files is inserted.	AUDIO: Plays only MP3/WMA files. STILL PICTURE: Plays only JPEG files. Once you have changed this setting, open and close the disc tray, or switch the power off and then back on again. The change then becomes effective.

AUDIO settings menu

Setting Item	Setting Contents
DIGITAL AUDIO OUTPUT Select the kind of output signal according to the equipment connected to the Optical Audio-Out port. For detailed signal information  p. 46	PCM ONLY: Use when connected to equipment that is only compliant with Linear PCM. DOLBY DIGITAL/PCM: Use when connected to a Dolby Digital Decoder or when connected to equipment with this function. STREAM/PCM: Use when connected to a DTS/Dolby Digital Decoder, or when connected to equipment with these functions.
DOWN MIX Toggles the signal from the Optical Audio-Out port, between “DIGITAL AUDIO OUTPUT” and “PCM ONLY”. The audio signal from the built-in speaker and the headphone jack is also changed.	DOLBY SURROUND: Use when connecting to equipment with built-in Dolby Pro-Logic decoder. STEREO: Use when connecting to standard equipment.
D. RANGE COMPRESSION Corrects the variation in the way we hear loud and quiet sounds when playing back at low volume. Only available for DVD videos that have been recorded in Dolby Digital.	AUTO: D. Range Compression is performed automatically. ON: D. Range Compression is always on.

OTHERS settings menu

Setting Item	Setting Contents
RESUME Selects whether or not to use the resume play feature when commencing playback again after playback has been stopped.	ON: Activates resume play. OFF: Playback starts from the beginning.
ON SCREEN GUIDE Selects whether or not to display the on-screen guide.	ON: Displayed. OFF: Not displayed.
PARENTAL LOCK Sets the parental lock that cuts extreme scenes from the DVD video and replaces them with other scenes.	COUNTRY CODE: Under normal circumstances, select GB.  p. 47 SET LEVEL: The smaller the numerical value, the greater the restriction. When “NONE” is selected, restriction is not performed. PASSWORD *: Make sure you set the password. The four digit password is set using the remote control numeric buttons (1-9,0). The password set here is input upon playback or at the next time you make changes to settings. If by any chance you forget the password, input 8888. EXIT: Exits the parental lock settings.

* The settings menu closes automatically if the password is incorrect 3 times.

Language code list

Code	Language	Code	Language	Code	Language	Code	Language
AA	Afar	GD	Scots Gaelic	MK	Macedonian	SN	Shona
AB	Abkhazian	GL	Galician	ML	Malayalam	SO	Somali
AF	Afrikaans	GN	Guarani	MN	Mongolian	SQ	Albanian
AM	Ameharic	GU	Gujarati	MO	Moldavian	SR	Serbian
AR	Arabic	HA	Hausa	MR	Marathi	SS	Siswati
AS	Assamese	HI	Hindi	MS	Malay (MAY)	ST	Sesotho
AY	Aymara	HR	Croatian	MT	Maltese	SU	Sundanese
AZ	Azerbaijani	HU	Hungarian	MY	Burmese	SV	Swedish
BA	Bashkir	HY	Armenian	NA	Nauru	SW	Swahili
BE	Byelorussian	IA	Interlingua	NE	Nepali	TA	Tamil
BG	Bulgarian	IE	Interlingue	NL	Dutch	TE	Telugu
BH	Bihari	IK	Inupiak	NO	Norwegian	TG	Tajik
BI	Bislama	IN	Indonesian	OC	Occitan	TH	Thai
BN	Bengali Bangla	IS	Icelandic	OM	(Afan) Oromo	TI	Tigrinya
		IW	Hebrew	OR	Oriya	TK	Turkmen
BO	Tibetan	JI	Yiddish	PA	Punjabi	TL	Tagalog
BR	Breton	JW	Javanese	PL	Polish	TN	Setswana
CA	Catalan	KA	Georgian	PS	Pashto, Pushto	TO	Tongan
CO	Corsican	KK	Kazakh	PT	Portuguese	TR	Turkish
CS	Czech	KL	Greenlandic	QU	Quechua	TS	Tsonga
CY	Welsh	KM	Cambodian	RM	Rhaeto-Romance	TT	Tatar
DA	Danish	KN	Kannada	RN	Kirundi	TW	Twi
DZ	Bhutani	KO	Korean (KOR)	RO	Rumanian	UK	Ukranian
EL	Greek	KS	Kashmiri	RU	Russian	UR	Urdu
EO	Esperanto	KU	Kurdish	RW	Kinyarwanda	UZ	Uzbek
ET	Estonian	KY	Kirghiz	SA	Sanskrit	VI	Vietnamese
EU	Basque	LA	Latin	SD	Sindhi	VO	Volapuk
FA	Persian	LN	Lingala	SG	Sangho	WO	Wolof
FI	Finnish	LO	Lao	SH	Serbo-Croatian	XH	Xhosa
FJ	Fijian	LT	Lithuanian	SI	Singhalese	YO	Yoruba
FO	Faroese	LV	Latvian, Lettish	SK	Slovak	ZU	Zulu
FY	Frisian	MG	Malagasy	SL	Slovenian		
GA	Irish	MI	Maori	SM	Samoan		

“DIGITAL AUDIO OUTPUT” settings and output signals

Playback Disc	“DIGITAL AUDIO OUTPUT” Settings		
	Stream/PCM	Dolby Digital/PCM	PCM Only
48 kHz, 16/20/24 bit Linear PCM DVD video 96 kHz Linear PCM DVD video	48 kHz, 16 bit stereo linear PCM		
DTS DVD video	DTS bit stream	48 kHz 16 bit linear PCM	
Dolby digital DVD video	Dolby digital bit stream		48 kHz, 16 bit stereo linear PCM
Audio CD Video CD SVCD	44.1 kHz, 16 bit stereo linear PCM/48 kHz, 16 bit linear PCM		
DTS Audio CD	DTS bit stream	44.1 kHz, 16 bit linear PCM	
MP3/WMA disc	32/44.1/48 KHz, 16 bit linear PCM		

Country (area) code list

AD	Andorra
AE	United Arab Emirates
AF	Afghanistan
AG	Antigua and Barbuda
AI	Anguilla
AL	Albania
AM	Armenia
AN	Netherlands Antilles
AO	Angola
AQ	Antarctica
AR	Argentina
AS	American Samoa
AT	Austria
AU	Australia
AW	Aruba
AZ	Azerbaijan
BA	Bosnia and Herzegovina
BB	Barbados
BD	Bangladesh
BE	Belgium
BF	Burkina Faso
BG	Bulgaria
BH	Bahrain
BI	Burundi
BJ	Benin
BM	Bermuda
BN	Brunei Darussalam
BO	Bolivia
BR	Brazil
BS	Bahamas
BT	Bhutan
BV	Bouvet Island
BW	Botswana
BY	Belarus
BZ	Belize
CA	Canada
CC	Cocos (Keeling) Islands
CF	Central African Republic
CG	Congo
CH	Switzerland
CI	Cote d'Ivoire
CK	Cook Islands
CL	Chile
CM	Cameroon
CN	China
CO	Colombia
CR	Costa Rica
CU	Cuba
CV	Cape Verde
CX	Christmas Island
CY	Cyprus
CZ	Czech Republic
DE	Germany
DJ	Djibouti
DK	Denmark
DM	Dominica
DO	Dominican Republic
DZ	Algeria
EC	Ecuador
EE	Estonia
EG	Egypt
EH	Western Sahara
ER	Eritrea
ES	Spain
ET	Ethiopia
FI	Finland
FJ	Fiji
FK	Falkland Islands (Malvinas)
FM	Micronesia (Federated States of)
FO	Faroe Islands
FR	France
FX	France, Metropolitan
GA	Gabon
GB	United Kingdom
GD	Grenada
GE	Georgia
GF	French Guiana
GH	Ghana
GI	Gibraltar
GL	Greenland
GM	Gambia
GN	Guinea
GP	Guadeloupe
GQ	Equatorial Guinea
GR	Greece
GS	South Georgia and the South Sandwich Islands
GT	Guatemala
GU	Guam
GW	Guinea-Bissau
GY	Guyana
HK	Hong Kong
HM	Heard Island and McDonald Islands
HN	Honduras
HR	Croatia
HT	Haiti
HU	Hungary
ID	Indonesia
IE	Ireland
IL	Israel
IN	India
IO	British Indian Ocean Territory
IQ	Iraq
IR	Iran (Islamic Republic of)
IS	Iceland
IT	Italy
JM	Jamaica
JO	Jordan
JP	Japan
KE	Kenya
KG	Kyrgyzstan
KH	Cambodia
KI	Kiribati
KM	Comoros
KN	Saint Kitts and Nevis
KP	Korea, Democratic People's Republic of
KR	Korea, Republic of
KW	Kuwait
KY	Cayman Islands
KZ	Kazakhstan
LA	Lao People's Democratic Republic
LB	Lebanon
LC	Saint Lucia
LI	Liechtenstein
LK	Sri Lanka
LR	Liberia
LS	Lesotho
LT	Lithuania
LU	Luxembourg
LV	Latvia
LY	Libyan Arab Jamahiriya
MA	Morocco
MC	Monaco
MD	Moldova, Republic of
MG	Madagascar
MH	Marshall Islands
ML	Mali
MM	Myanmar
MN	Mongolia
MO	Macau
MP	Northern Mariana Islands
MQ	Martinique
MR	Mauritania
MS	Montserrat
MT	Malta
MU	Mauritius
MV	Maldives
MW	Malawi
MX	Mexico
MY	Malaysia
MZ	Mozambique
NA	Namibia
NC	New Caledonia
NE	Niger
NF	Norfolk Island
NG	Nigeria
NI	Nicaragua
NL	Netherlands
NO	Norway
NP	Nepal
NR	Nauru
NU	Niue
NZ	New Zealand
OM	Oman
PA	Panama
PE	Peru
PF	French Polynesia
PG	Papua New Guinea
PH	Philippines
PK	Pakistan
PL	Poland
PM	Saint Pierre and Miquelon
PN	Pitcairn
PR	Puerto Rico
PT	Portugal
PW	Palau
PY	Paraguay
QA	Qatar
RE	Réunion
RO	Romania
RU	Russian Federation
RW	Rwanda
SA	Saudi Arabia
SB	Solomon Islands
SC	Seychelles
SD	Sudan
SE	Sweden
SG	Singapore
SH	Saint Helena
SI	Slovenia
SJ	Svalbard and Jan Mayen
SK	Slovakia
SL	Sierra Leone
SM	San Marino
SN	Senegal
SO	Somalia
SR	Suriname
ST	Sao Tome and Principe
SV	El Salvador
SY	Syrian Arab Republic
SZ	Swaziland
TC	Turks and Caicos Islands
TD	Chad
TF	French Southern Territories
TG	Togo
TH	Thailand
TJ	Tajikistan
TK	Tokelau
TM	Turkmenistan
TN	Tunisia
TO	Tonga
TP	East Timor
TR	Turkey
TT	Trinidad and Tobago
TV	Tuvalu
TW	Taiwan
TZ	Tanzania, United Republic of
UA	Ukraine
UG	Uganda
UM	United States Minor Outlying Islands
US	United States
UY	Uruguay
UZ	Uzbekistan
VA	Vatican City State (Holy See)
VC	Saint Vincent and the Grenadines
VE	Venezuela
VG	Virgin Islands (British)
VI	Virgin Islands (U.S.)
VN	Viet Nam
VU	Vanuatu
WF	Wallis and Futuna Islands
WS	Samoa
YE	Yemen
YT	Mayotte
YU	Yugoslavia
ZA	South Africa
ZM	Zambia
ZR	Zaire
ZW	Zimbabwe

Picture Quality Menu Operations and Functions

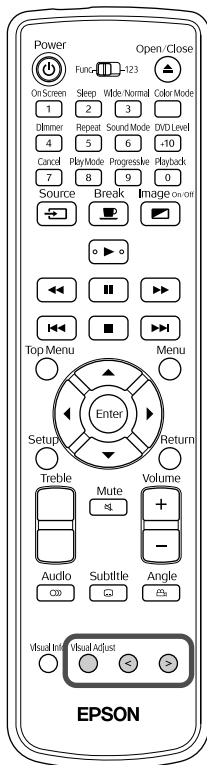

You can perform adjustments on the brightness, contrast, and other values of the projected image.

Using the Picture Quality menu





- 1 Press  during projection.
The following menu is displayed.



- 2 The menu item changes as follows whenever  is pressed. Press  repeatedly until the item that you want to change is displayed.

Brightness → Contrast → Color Saturation → Tint → Sharpness →
Keystone → Exit Picture Quality menu

- 3 Press   to make your adjustments.

- 4 When left in an unchanged state for a period of time, the adjustment closes and the Picture Quality menu disappears.
 - After making the adjustment, press , the adjustment closes and the Picture Quality menu disappears.

When in a settings menu, to return to the previous setting,

Press .

Picture Quality menu list

Setting Item	Setting Contents
Brightness	Adjusts the image brightness.
Contrast	Adjusts the difference between light and shade in the images.
Color Saturation	Adjusts the color saturation for the images.
Tint	Only displayed when an NTSC signal is being input. Adjusts the image tint.
Sharpness	Adjusts the image sharpness.
Keystone	<p>If the screen is not positioned vertically, the projected image is distorted in the shape of a keystone. You can correct keystone distortion in the following way.</p> 

Information Menu Operation and Functions

You can set the “Information” for checking the status of this unit, “Video Signal”, “High Altitude Mode”, and “Lamp-Hours Reset”.

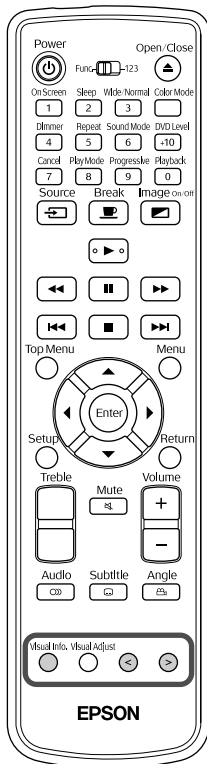

Using the Information menu



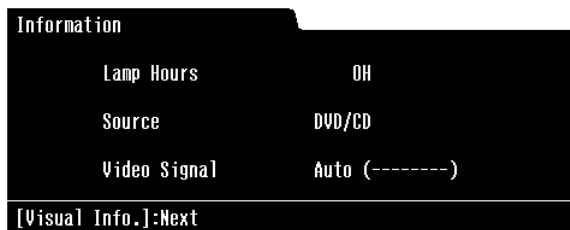

1 Press  during projection.

The following Information is displayed.



2 The menu item changes as follows whenever  is pressed. Press  repeatedly until the item that you want to confirm or change is displayed.

Information → Video Signal → High Altitude Mode → Lamp-Hours Reset → Exit Information menu

3 Press   to make your adjustments.

4 When left in an unchanged state for a period of time, the adjustment closes and the Information menu disappears.

- After making the adjustment, press , the adjustment closes and the Information menu disappears.

When in a settings menu, to return to the previous setting,

Press .

Information menu list

Setting Item	Setting Contents
Information Displays the current status.	<p>Lamp Hours: Accumulated usage time of the lamp. 0H is displayed for 0-10 hours. Displayed in units of 1 hour for 10 hours and above. The display changes to yellow text when it is time to change the lamp.</p> <p>Source: Displays whether standard DVD images are being projected, or images from external video equipment are being projected.</p> <p>Video Signal: Displays the format of the video signal being input.</p>
Video Signal	Sets the signal format of the video equipment connected to the Video input port or the S-Video input port. At the time of purchase, this is set to "Auto" so the video signal is recognized automatically. If interference appears in the projected images or no images appear when you select "Auto", select the appropriate signal manually.
High Altitude Mode	When using this unit in high altitude areas above 1500 m, select "ON".
Lamp-Hours Reset	If the lamp has been replaced, make sure you initialize this setting. The accumulated lamp operating time is cleared.

Appendix



Troubleshooting

Reading the indicators

You can check the status of this unit using the indicators on the top panel.



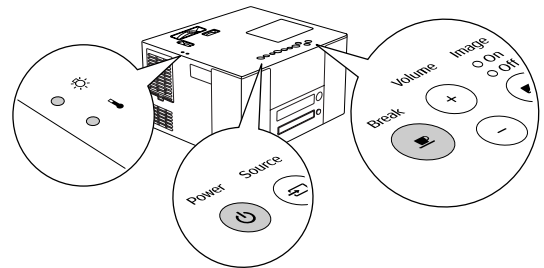

Check each condition in the following table and follow the steps to remedy the problem.































* If all indicators are switched off, check that the power cable is connected correctly and whether or not the main power switch is turned on.



When flashes green / orange alternately











Error

 : flashing green/orange alternately
 : lit  : flashing  : off

<p>Red  </p> <p>Red  </p> <p> </p>	<p>Internal error Turn the main power switch off then on. If the indicator status does not change once  has been pressed and the power switched on</p>	<p>Disconnect the power cable from the electrical outlet and contact your dealer.  p. 66</p>
<p> </p> <p>Red  </p> <p> </p>	<p>Fan related error/Sensor error</p>	
<p> </p> <p>Red  </p> <p> </p>	<p>High temperature error (overheating) The lamp turns off automatically and projection stops. After being in this state for around 40 seconds and then entering stand-by mode, check the 2 items listed to the right. If the power was turned off, turn the main power switch back on again.</p>	<p> p. 56</p> <p>If the indicator status does not change once  has been pressed and the power turned on</p>
<p>Red  </p> <p> </p> <p> </p>	<p>Lamp error/Lamp fails to light up/Lamp cuts out /Lamp cover open Check if the lamp is broken.  p. 58</p> <p>The lamp is not broken</p> <p>The lamp is broken</p>	<p>Reinsert the lamp then turn on the main power switch on the main unit and press  .</p> <p>If the condition is not fixed once the lamp is re-inserted</p> <p>Contact your dealer.  p. 66</p>

















When the or indicators flash orange **Warning**

● : lit  : flashing ○ : off

<p>Orange  </p> <p>Green </p>	<p>High-speed cooling in progress</p> <p>You can continue projecting in this state. Projection stops automatically if subsequent high temperatures are registered.</p>	<p>Check the 2 items listed to the right.</p> <ul style="list-style-type: none"> • Move this unit away from the wall by at least 20 cm. • Clean the air filter. <p> p. 56</p>	<p>If there is no improvement when you press  and switch the power on, discontinue use and disconnect the power cable from the electrical outlet. Contact your dealer.</p> <p> p. 66</p>
<p>Orange  </p> <p>Green </p>	<p>Lamp replacement notification</p> <p>It is time to replace the lamp. Replace the lamp with a new one as soon as possible. If you continue use when in this state, it is possible that the lamp may explode.  p. 58</p>		



When the or indicators are off **Normal**

● : lit  : flashing ○ : off









<p>  </p> <p>Orange Orange</p>	<p>Standing-by</p> <p>Shows that this unit is ready to be used.</p>	
<p>  </p> <p>Green Green Green</p>	<p>Warming up (approx. 20 seconds)</p> <p>In warm-up mode pressing  or  has no effect. Do not turn off the power or unplug the unit during warm-up, as this may reduce the lifespan of the lamp.</p>	
<p>  </p> <p>Green Green Green</p>	<p>Projection in Progress</p>	
<p> </p> <p>Green Orange</p>	<p>Cooling down (approx. 9 seconds)</p> <p>The operation of all remote control and main unit buttons is suspended during cool-down. Enters stand-by mode once cool-down has completed. Do not turn off the power or unplug the unit during cool-down, as this may reduce the lifespan of the lamp.</p>	
<p>  </p> <p>Green Green Green</p>	<p>Break</p> <p>Press  to return to normal playback.</p>	

When the indicators provide no help

If this unit is not functioning normally, check the following notes before requesting repairs. However, if the unit fails to improve, contact your dealer for advice.

At these times	Check here.	Reference page
Power does not turn on	• Is the main power switch in the on position?	☞ p. 13
	• Disconnect and reconnect the power cable.	☞ p. 13
	• Is the projector cooling down ?	☞ p. 53
	• If the indicator goes on and off when you touch the power cable, turn off the main power switch then disconnect and reconnect the power cable. If the unit fails to improve, it is possible that the power cable has been damaged. Stop using the projector, disconnect the power cable from the electrical outlet, and contact your dealer.	☞ p. 66
No images appear	• Is the Image Off indicator lit orange ?	☞ p. 23
	• You cannot play DVD videos if the disc region code does not correspond to the region code label on the side of this unit.	☞ p. 7
	• Press  to switch to DVD.	☞ p. 38
	• Is the lamp spent?	☞ p. 52
Images are fuzzy or out of focus	• Has the focus been adjusted ?	☞ p. 15
	• Is the lens cover in place ?	☞ p. 13
	• Is the projector at the correct distance?	☞ p. 60
	• Could there be condensation ?	☞ p. 5
Images appear dark	• Is the color mode appropriate to the usage environment ?	☞ p. 19
	• Is the lamp due for replacement?	☞ p. 57
	• Is the screensaver running ?	☞ p. 44
The remote control does not work	• Is the Function/Numerics toggle switch in the [1 2 3] (numerical input) position ?	☞ p. 21
	• Depending on the disc, certain operations are prohibited.	-
	• Are the batteries dead, or have the batteries been inserted correctly?	☞ p. 11
No sound can be heard or the sound is faint.	• Has the volume been adjusted to the minimum setting?	☞ p. 15
	• Is mute mode active? Press  .	-
	• Is the DVD level setting set to "DVD LEVEL 1" ?	☞ p. 42
The audio distorts	Is the volume too loud ?	☞ p. 15
The audio/subtitle language cannot be changed	If multiple languages are not recorded on the disc, they cannot be changed.	-
Subtitles do not appear	• If there are no subtitles on the disc, they are not displayed.	-
	• Is the subtitle language set to "OFF" ?	☞ p. 33
	• When using A-B repeat, subtitles may not be displayed before and after point A and point B.	-

When using external video modes

At these times	Check here.	Reference page
No images appear	<ul style="list-style-type: none"> • Is the power for the connected equipment turned on? Switch on the power to the connected equipment, or start playback depending on the playback method for the connected equipment. 	 p. 38
	<ul style="list-style-type: none"> • When signals have been connected to both the S-Video input port and the Video input port, only the S-Video signal is available. If you want to watch the image from the equipment connected to the Video input port, disconnect the cable from the S-Video input port. 	-
“Signal not supported” is displayed	If you cannot project even when the “Video Signal” is set to “Auto” in the Information menu, set to the signal format appropriate to the equipment.	 p. 51
“No signal.” is displayed	<ul style="list-style-type: none"> • Are the cables connected correctly? 	 p. 37, 38
	<ul style="list-style-type: none"> • Is the power to the connected equipment turned on ? Switch on the power to the connected equipment, or start playback depending on the playback method for the connected equipment. 	 p. 38
	<ul style="list-style-type: none"> • Press  to switch to DVD. 	 p. 38
The signal is distorted	If an extension cable is used, electrical interference may affect the signals. Connect amplification equipment and check.	-
Image is truncated (large) or small	The unit automatically recognizes and projects the aspect ratio for the input signal. If the aspect ratio is not projected correctly, press  and select the aspect ratio appropriate to the input signal.	-
Image colors are not right	In the Information menu, set the “Video Signal” to the signal format appropriate to the equipment.	 p. 51

Maintenance

This section describes maintenance tasks such as cleaning the projector and replacing consumable parts.

Cleaning

Cleaning the air filter

When dust builds up on the air filter, or the message “The projector is overheating. Make sure nothing is blocking the air vents, and clean or replace the air filter” is displayed, remove any dust from the air filter using a vacuum cleaner.

CAUTION

If dust collects on the air filter, it can cause the internal temperature of the projector to rise, and this can lead to problems with operation and shortening of the optical engine’s service life. It is recommended that you clean these parts at least once every three months. Clean them more often than this if using the projector in particularly dusty environments.

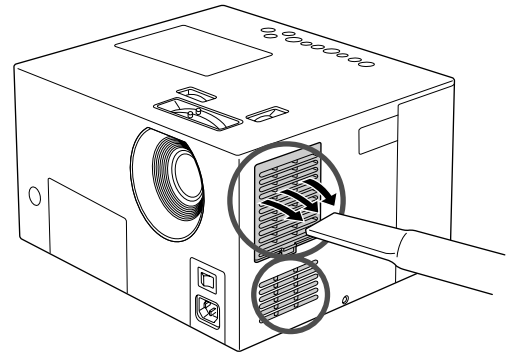

Cleaning the main unit

Clean the surface by wiping it gently with a soft cloth. If the projector is particularly dirty, moisten the cloth with water containing a small amount of neutral detergent, and then firmly wring the cloth dry before using it to wipe the projector’s surface. Then wipe it again with a soft, dry cloth.

CAUTION

Do not use volatile substances such as wax, alcohol, or thinner to clean the projector’s surface. These can cause the projector to warp and make the coating finish peel off.

Cleaning the projection lens

Use a commercially available air blower, or use a lens cleaning paper to gently wipe the lens.

CAUTION

Do not rub the lens with harsh materials or subject the lens to shocks, as it can easily become damaged.

Consumables replacement period

Air filter replacement period

When the air filter gets dirty or is broken

Replace it with the optional air filter.  "Optional Accessories and Consumables" p. 60

Lamp replacement period

- The message "Replace the lamp" appears on the screen when projection starts.
- The projected image gets darker or starts to deteriorate.



TIP

- In order to maintain the initial brightness and image quality, the lamp replacement message is displayed after about 1900 hours of use has passed. The time at which this message is displayed will vary depending on the color mode settings and the conditions under which this unit has been used.
- If you continue to use the lamp after this period, the possibility of the lamp breaking becomes greater. When the lamp replacement message appears, replace the lamp with a new one as soon as possible, even if it is still working.
- Depending on the characteristics of the lamp and on the way it has been used, the lamp may become darker or stop working before the lamp warning message appears. You should always have a spare lamp ready in case it is needed.
- Contact your dealer for a spare lamp.

How to replace consumables

Replacing the air filter



TIP

Dispose of used air filters properly in accordance with your local regulations.
Filter: Polypropylene

1 Once the power has turned off, cool-down has completed, and the projector has beeped twice, turn off the main power switch.

2 Remove the air filter cover.

Place your finger in the hollow and lift upwards.

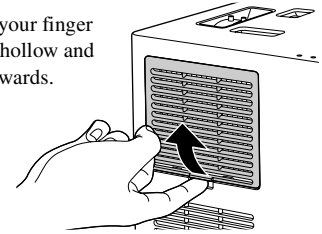

Replacing the lamp

CAUTION

The lamp is hot immediately after use. Once the power has been switched off, allow approximately one hour to pass before replacing the lamp to allow it to cool thoroughly.

1 Once the power has turned off, cool-down has completed, and the projector has beeped twice, turn off the main power switch.

2 Remove the lamp cover by inserting the screwdriver that came with the replacement lamp into the lamp cover opening latch.

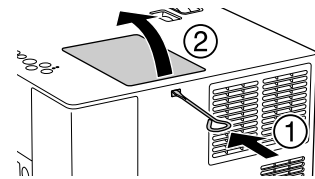

6 Tighten the lamp attachment screws firmly.

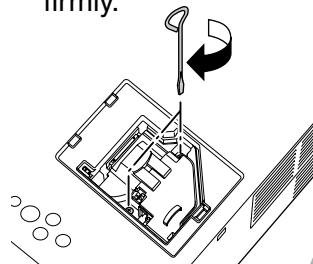

7 Install the lamp cover.

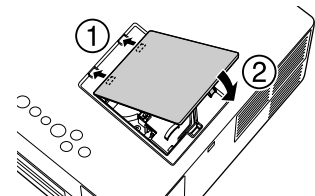

Resetting the lamp operating time

After the lamp has been replaced, make sure you initialize the Lamp Hours setting.

The projector has a built-in counter that keeps track of the lamp operating time and the lamp replacement message is displayed based on this counter.

1 Turn on the main power switch on the main unit then press . If the lamp is not lit, press



2 If you press  repeatedly during projection, "Lamp-Hours Reset" is displayed.



3 Take out the old air filter.

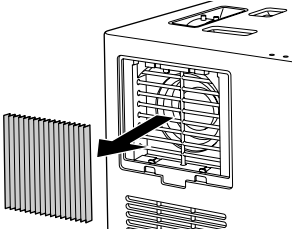

4 Install the new air filter.

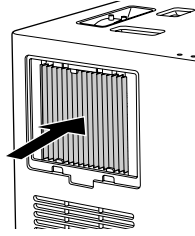

5 Install the filter cover.

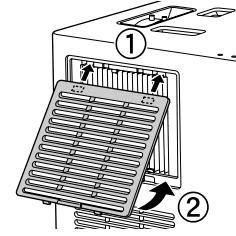

3 Loosen the lamp attachment screws.

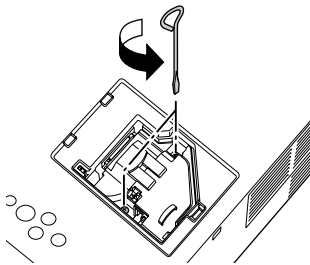

4 Take out the old lamp. If replacing the lamp yourself, be careful to avoid pieces of broken glass.



5 Install the new lamp.

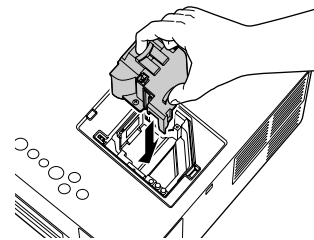

CAUTION

- Install the lamp and the lamp cover securely. For the safety of this unit, the lamp will not turn on if the lamp or the lamp cover is not installed correctly.
- The lamp contains mercury. Dispose of used lamps properly in accordance with your local regulations.

3 Press and select "Yes". Reset is performed when you press .

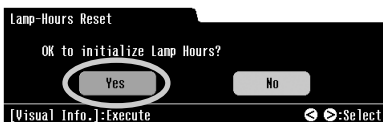

Optional Accessories and Consumables

The following optional accessories and consumables are available for purchase if required. This list of optional accessories is current as of August, 2005. Details of accessories are subject to change without notice.

Consumables

Lamp unit ELPLP33 (Lamp x1) Use as a replacement for used lamps.	Air filter set ELPAF09 (Air filter x1) Use as a replacement for used air filters.
--	---

Optional accessories

50" Portable screen ELPSC06 60" Portable screen ELPSC07 80" Portable screen ELPSC08 A compact screen which can be carried easily. (Aspect ratio 4:3)	Powered subwoofer ELPSP01 Enjoy richer, more powerful bass.
--	--

Projection Distance and Screen Size

Refer to the following table and place the unit in a position which allows the best possible projection for the size of the screen.

Units: cm (in.)

Units: cm (fit.)

16:9 Screen Size		Projection Distance	
		Minimum (Zoom Adjustment Wide)	Maximum (Zoom Adjustment Tele)
30"	66 x 37 (26 x 15)	73 - 111 (2.4 - 3.7)	
40"	89 x 50 (35 x 20)	99 - 149 (3.2 - 4.9)	
60"	130 x 70 (51 x 28)	149 - 225 (4.9 - 7.4)	
80"	180 x 100 (71 x 39)	200 - 301 (6.6 - 9.9)	
100"	220 x 120 (87 x 47)	251 - 377 (8.2 - 12.4)	
120"	270 x 150 (106 x 59)	301 - 453 (9.9 - 14.9)	
150"	330 x 190 (130 x 75)	377 - 567 (12.4 - 18.6)	

Units: cm (in.)

Units: cm (fit.)

4:3 Screen Size		Projection Distance	
		Minimum (Zoom Adjustment Wide)	Maximum (Zoom Adjustment Tele)
30"	61 x 46 (24 x 18)	90 - 136 (2.9 - 4.5)	
40"	81 x 61 (32 x 24)	121 - 183 (4.0 - 6.0)	
60"	120 x 90 (47 x 35)	183 - 276 (6.0 - 9.0)	
80"	160 x 120 (63 x 47)	245 - 369 (8.0 - 12.1)	
100"	200 x 150 (79 x 59)	307 - 462 (10.1 - 15.2)	
120"	240 x 180 (94 x 71)	369 - 555 (12.1 - 18.2)	
150"	300 x 230 (118 x 91)	462 - 694 (15.1 - 22.8)	

Specifications / Compliant Resolutions

Product name	EMP-TWD1			
Dimensions	340(W) x 180(H) x 310(D) mm (excluding feet)			
Panel size	0.55-inch wide			
Display method	Polysilicon TFT active matrix			
Resolution	409,920 pixels (854 (W) x 480 (H)dots) x 3			
Focus adjustment	Manual			
Zoom adjustment	Manual (approx. 1:1.5)			
Lens shift	Manual (vertical maximum approx. 50%, horizontal maximum approx. 25%)			
Lamp (light source)	UHE lamp, 135 W, Model No.: ELPLP33			
Power supply	100-240VAC 50/60 Hz 2.6 - 1.2 A			
	Power Consumption Operating: 230 W (100 - 120 V area), 220 W (220 - 240 V area) Standby: 6 W (100 - 120 V area), 9 W (220 - 240 V area)			
Operating temperature	+5° - +35°C (No condensation)			
Storage temperature	-10° - +60°C (No condensation)			
Weight	Approximately 7.0kg			
Connectors	Input	Audio port	1	RCA pin jack
		S-Video port	1	Mini DIN 4-pin
		Video port	1	RCA pin jack
	Output	Subwoofer port	1	RCA pin jack
		Optical Audio-Out port	1	Square optical jack
		Headphone jack	1	3.5mm mini-jack
Speaker	Output sound wave pressure level 79 dB/Wm Maximum input (JIS) 10W Rated impedance 4Ω			
Audio output	Analog audio output	1 speaker system: Practical, maximum output 10W + 10W (10% THD JEITA/4Ω)		
		1 headphone system: 12 mW/32Ω Acceptable impedance 16Ω - 1kΩ		
		1 subwoofer system (L+R): 0.25 Vrms/27 kΩ		
		Dynamic range 70 dB (JEITA) or more		
		Total harmonic distortion rate 0.5% (JEITA) or less		
	Digital audio output	Light: -21dBm to -15 dBm		
Readable disc types	DVD video, Video CD, SVCD, Audio CD, CD-R/RW (Audio CD, Video CD, SVCD, MP3/WMA, JPEG format), DVD-R/RW (DVD video format)			



Pixelworks DNX™ IC is installed in this unit.

Composite Video/S-Video

Signal	Resolution	Aspect Mode	
		Normal	Wide
TV (NTSC)	640 × 480	640 × 480 (4:3)	854 × 480 (16:9)
TV(PAL, SECAM)	768 × 576	640 × 480 (4:3)	854 × 480 (16:9)

Safety

USA

UL60950 3rd Edition

UL60065 7th Edition

Canada

CSA C22.2 No.60950

CSA C22.2 No.60065

European Community

The Low Voltage Directive

(73/23/EEC)

IEC60950 3rd Edition

IEC60065 7th Edition

EMC

USA

FCC Part 15B Class B (DoC)

Canada

ICES-003 Class B

European Community

The EMC Directive

(89/336/EEC)

EN55022 Class B

EN55024

IEC/EN61000-3-2

IEC/EN61000-3-3

EN55013: 2001+AI: 2003

EN55020: 2002+AI: 2003

EN61000-4-2

EN61000-4-3

EN61000-4-4

Australia/New Zealand

AS/NZS CISPR 22:2002 Class B

AS/NZS CISPR 13

DECLARATION of CONFORMITY

According to 47CFR, Part 2 and 15
Class B Personal Computers and Peripherals; and/or
CPU Boards and Power Supplies used with Class B
Personal Computers

We : EPSON AMERICA, INC.
Located at : 3840 Kilroy Airport Way
MS: 3-13
Long Beach, CA 90806
Tel : 562-290-5254

Declare under sole responsibility that the product identified herein, complies with 47CFR Part 2 and 15 of the FCC rules as a Class B digital device. Each product marketed, is identical to the representative unit tested and found to be compliant with the standards. Records maintained continue to reflect the equipment being produced can be expected to be within the variation accepted, due to quantity production and testing on a statistical basis as required by 47CFR 2.909. Operation is subject to the following two conditions : (1) this device may not cause harmful interference, and (2) this device must accept any interference received, including interference that may cause undesired operation.

Trade Name : EPSON
Type of Product : Projector
Model : EMP-TWD1

FCC Compliance Statement For United States Users

This equipment has been tested and found to comply with the limits for a Class B digital device, pursuant to Part 15 of the FCC Rules. These limits are designed to provide reasonable protection against harmful interference in a residential installation. This equipment generates, uses, and can radiate radio frequency energy and, if not installed and used in accordance with the instructions, may cause harmful interference to radio or television reception. However, there is no guarantee that interference will not occur in a particular installation. If this equipment does cause interference to radio and television reception, which can be determined by turning the equipment off and on, the user is encouraged to try to correct the interference by one or more of the following measures.

- Reorient or relocate the receiving antenna.
- Increase the separation between the equipment and receiver.
- Connect the equipment into an outlet on a circuit different from that to which the receiver is connected.
- Consult the dealer or an experienced radio/TV technician for help.

WARNING

The connection of a non-shielded equipment interface cable to this equipment will invalidate the FCC Certification or Declaration of this device and may cause interference levels which exceed the limits established by the FCC for this equipment. It is the responsibility of the user to obtain and use a shielded equipment interface cable with this device. If this equipment has more than one interface connector, do not leave cables connected to unused interfaces. Changes or modifications not expressly approved by the manufacturer could void the user's authority to operate the equipment.

Glossary

JPEG

A file format used for saving image files. Most photographs taken with digital cameras are saved in the JPEG format.

MP3

The abbreviated form of “MPEG1 Audio Layer-3”, a standard for audio compression. It enables the size of the data to be greatly reduced, whilst maintaining a high sound quality.

NTSC

The abbreviated form of the “National Television Standards Committee”, and given to one of the analog color television wave transmission systems. This system is used in Japan, the USA and Latin America.

PAL

The abbreviated form of “Phase Alteration by Line”, and given to one of the analog color television wave transmission systems. This system is used in China, Western Europe, with the exception of France, and in other African and Asian countries.

SECAM

The abbreviated form of “SEquential Couleur A Memoire”, and given to one of the analog color television wave transmission systems. This system is used in France, Eastern Europe, the former Soviet Union, the Middle East and some African nations.

WMA

The abbreviated form of “Windows Media Audio”, an audio compression technology developed by the Microsoft Corporation of America. You can encode WMA data using Windows Media Player Ver.7, 7.1, Windows Media Player for Windows XP, or the Windows Media Player 9 Series.

Windows Media and the Windows logo, are trademarks or registered trademarks of the Microsoft Corporation of America, in America and in other countries.

When encoding WMA files, please use applications that have been certified by the Microsoft Corporation of America. If you use an application that has not been certified, it is possible that it may not operate correctly.

Aspect ratio

The ratio between an image's length and its height. HDTV images have an aspect ratio of 16:9 and appear elongated. The aspect ratio for standard images is 4:3.

Cool-down

A process to enable the lamp to cool down from the high temperatures attained during projection. Performed automatically when this unit is turned off. Do not remove the power plug during cool-down. If cool-down is not performed correctly, the lamp or internal structure of the main unit can overheat which may reduce the lifespan of the lamp or cause damage to this unit. Cool-down is complete once the main unit beeps twice.

Parental Lock

For age restriction. There are also display level settings for when a DVD video contains material which is undesirable for viewers of a young age.

Dynamic Range

Shows the ratio of minimum and maximum audio level values recorded to a disc in decibels (dB). The dynamic range values indicate what detailed signals can be reproduced by various equipment.

Optical digital out

Converts the audio signal into a digital signal and enables it to be transmitted along optical fiber. An advantage is that interference is not produced, unlike conventional means, where external interference is picked up by the cable.

Playback control (PBC)

A method for playing back Video CDs. You can select the screen or information you want to see from the menu screen displayed.

Disc related terms

Title/Chapter/Track

One movie on a DVD is divided into units called titles, which may contain any number of chapters. Video and Audio CDs are divided into units called tracks.

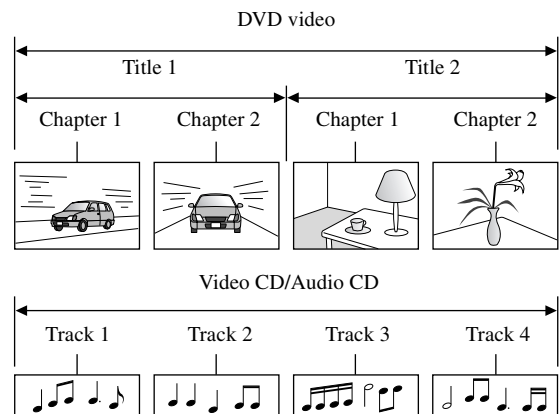

Index

A

A.STBY	35
Air exhaust vent	8
Air intake vent	8
Angle	33
Aspect ratio	55, 64
Audio input level	42
AUDIO settings menu	45

B

Break	19
Brightness	49

C

Chapter	64
Cleaning the air filter	56
Cleaning the lens	56
Cleaning the main unit	56
Color Mode	19
Color Saturation	49
Consumables	60
Contrast	49

D

D. RANGE COMPRESSION	45
DIGITAL AUDIO OUTPUT	45
Dimmer	20
Display window	14
Dolby Digital	45
DOWN MIX	45
DVD level	42

F

File	23
FILE TYPE	44
Focus adjustment	15

G

Group (folder)	23
----------------------	----

H

Headphones	39
High Altitude Mode	51
How to replace the batteries	11

I

Image On/Off	23
Indicator	52
Information	51
Input Signal	51

J

JPEG	23
------------	----

K

Keystone	49
----------------	----

L

Lamp replacement period	57
Lamp-Hours	51
LANGUAGE settings menu	44
Lens shift	15

M

Main power switch	13
Menu	21
Menu bar	34
MP3	23
Mute	19

O

ON SCREEN GUIDE	45
ON SCREEN LANGUAGE	44
Optional accessories	60
OTHERS settings menu	45
Overheating	52

P

PARENTAL LOCK	45
PBC (playback control)	22
PICTURE settings menu	44
PICTURE SOURCE	44
Power inlet port	8

R

Remote control	10
Replacing the air filter	58
Replacing the lamp	58
Resetting the lamp operating time	58
RESUME	45

S

SCREEN SAVER	44
Sharpness	49
Slideshow playback	23
Source	51
Standing-by	53
Status bar	26
SVCD	7
S-Video input port	38

T

Tint	49
Title	64
Track	64
Tray lock	36

V

Video input port	37
Video Signal	51
Volume	15

Z

Zoom adjustment	15
-----------------------	----

Address List

This address list is current as of the 6th of December 2004.

A more up-to-date contact address can be obtained from the corresponding website listed here. If you do not find what you need on any of these pages, please visit the main EPSON home page at www.epson.com.

< EUROPE >

AUSTRIA :

EPSON Support Center Austria

Tech. Help Desk:
00491805 235470
Web Address:
<http://www.epson.at>

BELGIUM :

EPSON Support Center BeNeLux

Tech. Help Desk:
032 702 22082
Web Address:
<http://www.epson.be>

BULGARIA :

PROSOFT

6. AIJendov Str. BG-1113 Sofia
Tel: 00359.2.730.231
Fax: 00359.2.9711049
E-mail: Prosoft@internet-BG.BG

CROATIA :

Recro d.d.

Trg. Sportova 11
HR-10000 Zagreb
Tel: 00385.1.6350.777
Fax: 00385.1.6350.716
E-mail: recro@recro.hr
Web Address:
<http://Www.recro.hr>

CYPRUS :

CTC- INFOCOM

6a. Ionos Str., Engomi
P. O. Box 1744
2406 Nicosia, Cyprus
Tel: 00357.2.458477
Fax: 00357.2.668490

CZECH :

EPRINT s.r.o.

Stresovicka 49
CZ-16200 Praha 6
Tel: 00420.2.20180610
Fax: 00420.2.20180611
E-mail: eprint@mbx.vol.cz

DENMARK :

Tech. Help Desk: 70 279 273
Web Address:
<http://www.epson.dk>

FINLAND :

Tech. Help Desk: 0201 552090
(note. Some geographical areas
excluded)
Web Address:
<http://www.epson.fi>

FRANCE :

EPSON France,

68 bis rue Marjolin, F-92300
Levallois,
Tech. Help Desk: 0.821.017.017
Web Address:
<http://www.epson.fr>

GERMANY :

EPSON Deutschland GmbH

Zulpicher StraBe 6 40549 Dusseldorf
Tech. Help Desk: 01805 235470
Web Address:
<http://www.epson.de>

GREECE :

Pouliadis Ass. Corp.

Aristotelous St. 3
GR-19674 Athens
Tel: 0030.1.9242072
Fax: 0030.1.9441066

HUNGARY :

R.A. Trade Kft.

Petofi Sandor u. 64
H-2040 Budaor
Tel: 0036.23.415.317
Fax: 0036.23.417.310

IRELAND :

Tech. Help Desk: 01 679 9015
Web Address:
<http://www.epson.ie>

ITALY :

EPSON Italia s.p.a.

Assistenza e Servizio Clienti Viale F.
Lli Casiragi, 427 20099 Sesto San
Giovanni (MI)
Tech. Help Desk: 02.29400341
Web Address:
<http://www.epson.it>

LUXEMBURG :

EPSON Support Center BeNeLux

Tech. Help Desk: 0032 70 222082
Web Address:
<http://www.epson.be>

MACEDONIA :

Rema Kompjuteri d.o.o.

St. Naroden Front 19a lok 16
91000 Skopje/ Macedonia
Tel: 00389.91.118159
Fax: 00389.91.118159

NETHERLANDS :

EPSON Support Center BeNeLux

Tech. Help Desk: 043 3515752
Web Address:
<http://www.epson.nl>

NORWAY :

Tech. Help Desk: 815 35 180
Web Address:
<http://www.epson.no>

POLAND :

FOR EVER Sp. z.o.o.

Ul. Frankciska Kawy 44 PL- 01-496
Warszawa
Tel: 0048.22.638.9782
Fax: 0048.22.638.9786
E-mail: office@for-ever.com.pl

PORTUGAL :

EPSON Portugal, S.A.

Rua do Progresso, 471-1
Perafita- Apartado 5132
Tech. Help Desk: 0808 200015
Web Address:
<http://www.epson.pt>

ROMANIA :

MB Distribution S.R. L.

162, Barbu Vacarescu Blvd. Sector 2
RO- 71422 Bucharest
Tel: 0040.1.2300314
Fax: 0040.1.2300313
E-mail: office@mbd-epson.ro

SLOVAKIA :**Print Trade spol. s.r.o.**

Cajkovskeho 8
SK-98401 Lucenec
Tel: 00421.863.4331517
Fax: 00421.863.4325656
E-mail: Prntrd@lc.psg.SK
Web Address:
<http://www.printtrade.sk>

SLOVENIA :**Repro Ljubljana d.o.o.**

Smartinska 106
SLO-1001 Ljubljana
Tel: 00386.61.1853411
Fax: 00386.61.1400126

SPAIN :**EPSON IBERICA, S.A.**

Avda. Roma 18-26,
08290 Cerdanyola del Valles,
Barcelona, SPAIN
Tech. Help Desk: 902.404142
E-mail: soporte@epson.es
Web Address:
<http://www.epson.es>

SWEDEN :

Tech. Help Desk: 077 140 01 34
Web Address:
<http://www.epson.se>

SWITZERLAND :**EXCOM Service AG**

Moosacher Str. 6
CH-8820 Wadenswil
Tel: 01.7822111
Fax: 01.7822349
Web Address:
<http://www.excom.ch>

TURKEY :**Romar Pazarlama Sanayi ve TIC. A.S.**

Rihtim Cad. No. 201
Tahir Han
TR-Karakoy-Istanbul
Tel: 0090.212.2520809
Fax: 0090.212.2580804

UNITED KINGDOM :**EPSON (UK) Ltd.**

Campus 100, Maylands Avenue
Hemel Hempstead, Herts, HP2 7TJ
Tech. Help Desk: 0990 133640
Web Address:
<http://www.epson.co.uk>

YUGOSLAVIA :**BS Procesor d.o.o.**

Hadzi Nikole Zivkovicica 2
11000 Beograd
Tel: 00381.11.639610
Fax: 00381.11.639610

< OCEANIA >**AUSTRALIA :****EPSON AUSTRALIA
PTYLIMITED**

3, Talavera Road,
N.Ryde NSW 2113,
AUSTRALIA
Tel: 1300 361 054
Web Address:
<http://www.epson.com.au>

All rights reserved. No part of this publication may be reproduced, stored in a retrieval system, or transmitted in any form or by any means, electronic, mechanical, photocopying, recording, or otherwise, without the prior written permission of SEIKO EPSON CORPORATION. No patent liability is assumed with respect to the use of the information contained herein. Neither is any liability assumed for damages resulting from the use of the information contained herein.

Neither SEIKO EPSON CORPORATION nor its affiliates shall be liable to the purchaser of this product or third parties for damages, losses, costs, or expenses incurred by purchaser or third parties as a result of: accident, misuse, or abuse of this product or unauthorised modifications, repairs, or alterations to this product, or (excluding the U.S.) failure to strictly comply with SEIKO EPSON CORPORATION's operating and maintenance instructions.

SEIKO EPSON CORPORATION shall not be liable against any damages or problems arising from the use of any options or any consumable products other than those designated as Original EPSON Products or EPSON Approved Products by SEIKO EPSON CORPORATION.

General Notice:

EPSON is a registered trademark of SEIKO EPSON CORPORATION.

Manufactured under license from Dolby Laboratories. "Dolby" and the double-D symbol are trademarks of Dolby Laboratories.

Manufactured under license from Digital Theater Systems, Inc. , "DTS" and "DTS 2.0 + Digital Out" are trademarks of Digital Theater Systems, Inc.

3LCD logo is a trademark of SEIKO EPSON CORPORATION.

Windows Media and the Windows logo are trademarks or registered trademarks of the Microsoft Corporation of America in America and in other countries.

Pixelworks and DNX are trademarks of Pixelworks, Inc.

The DVD video logo is a trademark.

Other product names used herein are also for identification purposes only and may be trademarks of their respective owners. EPSON disclaims any and all rights in those marks.

EPSON®

