

EPSON® PowerLite® 500c/700c/710c Multimedia Projector



User's Guide ***Supplement***

Important Safety Information

WARNING: Never look into the projector lens when the lamp is turned on; the bright light can damage your eyes. Never let children look into the lens when it is on. Never open any cover on the projector, except the lamp and filter covers. Dangerous electrical voltages inside the projector can severely injure you. Except as specifically explained in the User's Guide or this Supplement, do not attempt to service this product yourself. Refer all servicing to qualified service personnel.

WARNING: The projector and its accessories come packaged in plastic bags. Keep plastic bags away from small children to avoid any risk of suffocation.

Caution: When you replace the lamp, never touch the new lamp with your bare hands; the invisible residue left by the oil on your hands may shorten the lamp life. Use a cloth or glove to handle the new lamp.

Copyright Notice

All rights reserved. No part of this publication may be reproduced, stored in a retrieval system, or transmitted in any form or by any means, electronic, mechanical, photocopying, recording, or otherwise, without the prior written permission of SEIKO EPSON CORPORATION. The information contained herein is designed only for use with this EPSON printer. EPSON is not responsible for any use of this information as applied to other printers.

Neither SEIKO EPSON CORPORATION nor its affiliates shall be liable to the purchaser of this product or third parties for damages, losses, costs, or expenses incurred by purchaser or third parties as a result of: accident, misuse, or abuse of this product or unauthorized modifications, repairs, or alterations to this product, or (excluding the U.S.) failure to strictly comply with SEIKO EPSON CORPORATION's operating and maintenance instructions.

SEIKO EPSON CORPORATION shall not be liable for any damages or problems arising from the use of any options or any consumable products other than those designated as Original EPSON Products or EPSON Approved Products by SEIKO EPSON CORPORATION.

EPSON is a registered trademark of SEIKO EPSON CORPORATION.

PowerLite is a registered trademark of Epson America, Inc.

General Notice: Other product names used herein are for identification purposes only and may be trademarks of their respective owners. EPSON disclaims any and all rights in those marks.

C

Contents

Connecting to a Desktop Computer

Positioning the Projector	5
Identifying the Projector Ports	7
Connecting to a PC Desktop Computer	7
Connecting the Computer Cable	8
Connecting the Audio Cable	9
Connecting the Cable for Remote Mouse Control	9
Connecting to a Desktop Macintosh	10
Connecting the Computer Cable	11
Connecting the Audio Cable	13
Connecting the Cable for Remote Mouse Control	13
Turning the Projector On and Off	14
Turning On Other Equipment	16

Using the Projector Menus

Changing Menu Settings	18
Video Menu (Computer Image Source)	20
Video Menu (Video Image Source)	22
Audio Menu	23
Effect Menu	24
Setting Menu	25
User's Logo Feature	26
Capturing the Image	26
Assigning the Image to the No-Signal Message and/or A/V Mute Button	29
Advanced Menu	30
About Menu (Computer Image Source)	31
About Menu (Video Image Source)	32
Reset All Feature	32

*Technical
Specifications*

General33
Projection Lamp34
Remote Control34
Mouse Compatibility34
Remote IR Receiver34
Mechanical34
Electrical34
Environmental34
Safety35
CE Marking35
Supported Monitor Displays35
Computer Connector Pin Assignments37

Index

A Appendix A: Connecting to a Desktop Computer

note

*For instructions on connecting to a laptop computer or to external speakers, see your *User's Guide*.*

This appendix describes how to connect the projector to your desktop computer and turn everything on. The projector must be connected to a computer or a video source such as a VCR, camcorder, digital camera, DVD player, or laser disc player before it can project any images. You may also want to set up the projector for one or more of the following:

- Connect the mouse cable to use the remote control as a wireless mouse. Except for some laptops, this disables your computer's mouse. You use the remote control's pointer to control the screen cursor.
- Provide audio for one or both image sources. The audio source can be the computer, video source, or another device such as a stereo.
- Connect to an external speaker or PA system to amplify the audio (see your *User's Guide* for instructions).

Positioning the Projector

Before you can set up the projector, you need to decide where to place it. Keep the following in mind:

- Place the projector on a sturdy, level surface.
- Make sure the projector is within 10 feet of a grounded electrical outlet or extension cord.
- Place the computer and/or video source within 5 feet of the projector.
- Make sure the projector is at right angles to the screen. Otherwise, your image will be distorted.

note

It is easier to position the projector when the screen is directly in front of the room. If the screen is placed diagonally in a corner, it is much more difficult to position the projector perpendicular to the screen and get a non-distorted image.

Most presenters find it convenient to place the projector (and computer) in the front of the room. With this arrangement, the projector is placed close to the screen. You need to raise the front of the projector (by extending the legs) in order to position the image high enough on the screen. Then you can use the projector's keystone control to correct the distortion caused by tilting up the front of the projector.

The distance between the projector and the screen determines the actual image size. Use the general guidelines in the table below to determine the proper distance.

Image size (diagonal)	Horizontal distance from projector to screen	
	Minimum (lens set to W)	Maximum (lens set to T)
2.2 feet (0.7 meter)	—	3.6 feet (1.1 meters)
2.5 feet (0.8 meter)	3.6 feet (1.1 meters)	4.3 feet (1.3 meter)
3.3 feet (1.0 meter)	4.8 feet (1.5 meters)	5.6 feet (1.7 meters)
5.0 feet (1.5 meters)	7.5 feet (2.3 meters)	8.9 feet (2.7 meters)
6.7 feet (2.0 meters)	9.8 feet (3.0 meters)	11.8 feet (3.6 meters)
8.3 feet (2.5 meters)	12.5 feet (3.8 meters)	14.8 feet (4.5 meters)
12.5 feet (3.8 meters)	18.7 feet (5.7 meters)	22.6 feet (6.9 meters)
16.7 feet (5.1 meters)	25.3 feet (7.7 meters)	30.2 feet (9.2 meters)
25 feet (7.6 meters)	37.7 feet (11.5 meters)	45.3 feet (13.8 meters)

Identifying the Projector Ports

The following illustrations identify all the interface ports on the back and side of the projector; you may want to refer to them as you connect your computer or other equipment to the projector.

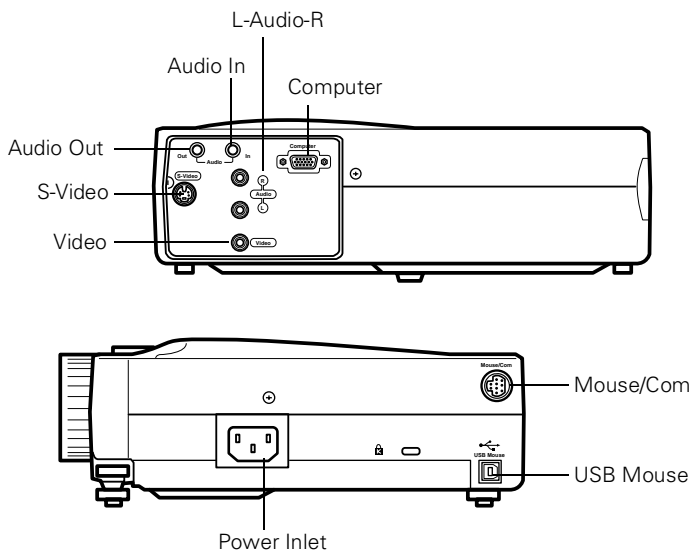

Connecting to a PC Desktop Computer

To connect the projector to your PC desktop computer, you need to:

- Connect the computer cable
- Connect the audio cable (if you'll be projecting with audio)
- Connect the mouse cable (if you want to use the remote control as a mouse)

note

Computer configurations vary. See your computer manual for the location of the ports needed to connect your projector.

If you connect the projector to your desktop computer, you cannot view your images on the computer monitor.

Follow the steps in each section for the cables you need to connect.

Connecting the Computer Cable

Before you start, make sure your projector, computer, and all peripherals are all turned off.

1. Disconnect the monitor cable from the monitor port on the back of your computer.
2. Connect one end of the projector's computer cable to the projector's Computer port.

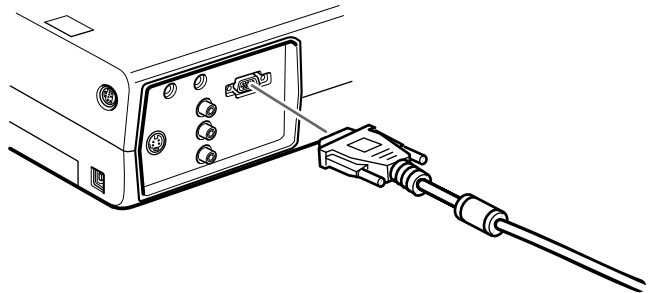

3. Connect the other end of the cable to your computer's video (monitor) port.

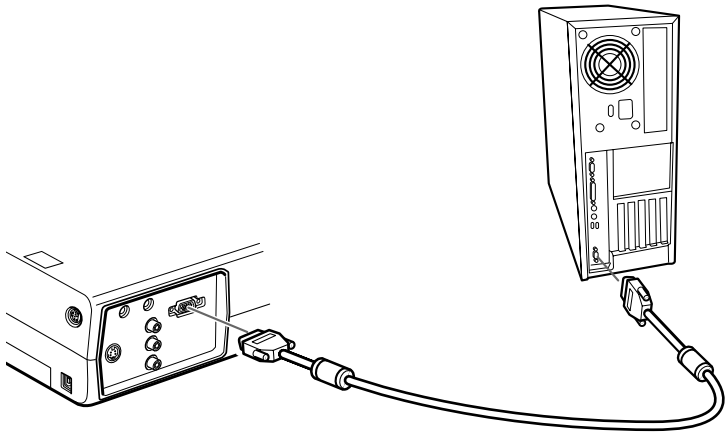

4. Tighten the screws on all connectors.

If you don't need to make any other connections, you can plug in your projector and turn it on. See page 14 for instructions.

note

If you need maximum volume (in a large auditorium, for example), you can also connect external speakers or a public address system to the projector. See your User's Guide for instructions.

Connecting the Audio Cable

If your presentation includes sound effects or other types of computer audio, you need to connect the audio cable.

1. Connect one end of the audio cable to the **Audio In** jack on the projector.

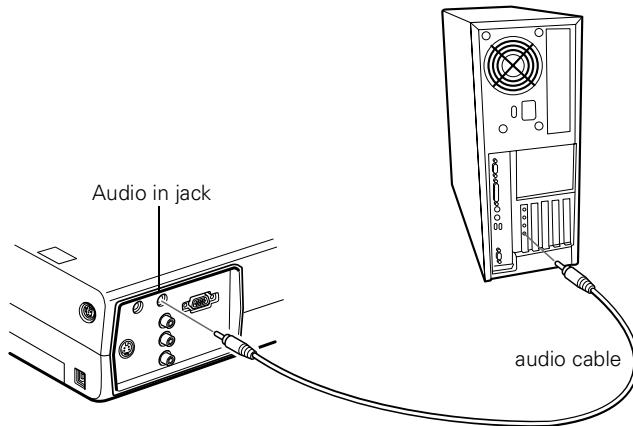

2. Connect the other end of the audio cable to the speaker or audio out port on your computer's sound card.

Connecting the Cable for Remote Mouse Control

Using the remote control as a wireless mouse gives you more flexibility. You can deliver your presentation from anywhere in the room and interact with the audience. You don't need to stand near your computer or near the projector.

You'll use different cables and different ports on the projector, depending on whether your computer has a round PS/2 mouse port or a flat USB mouse port.

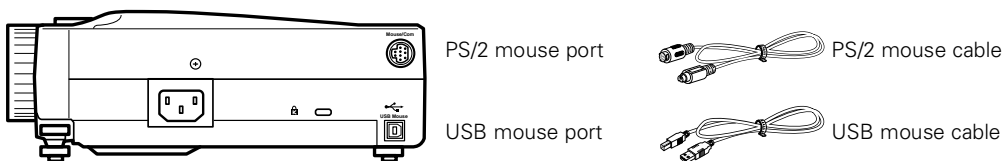

1. Determine which type of mouse port your computer has:
 - Round PS/2 mouse port
 - Flat USB mouse port
2. Connect one end of the appropriate mouse cable to the PS/2 Mouse/Com port or the USB Mouse port on the projector.

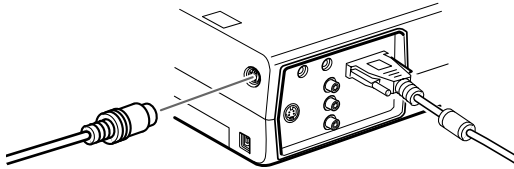

connecting PS/2 mouse cable

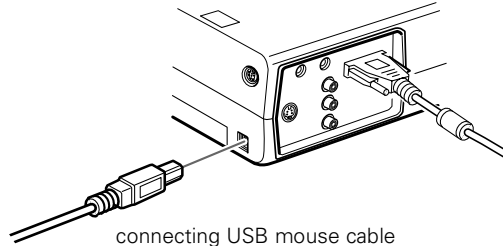

connecting USB mouse cable

3. Connect the other end to the mouse port on your computer. (Your computer's mouse will be disabled while you are using the remote control as a mouse.)

Connecting to a Desktop Macintosh

note

Macintosh configurations vary. See your computer manual for the location of the ports needed to connect your projector.

To connect the projector to your desktop Macintosh,[®] you need to:

- Connect the computer cable
- Connect the audio cable (if you'll be projecting with audio)
- Connect the mouse cable (if you want to use the remote control as a mouse)

If you connect the projector to your Macintosh, you cannot view your images on the computer monitor.

Follow the steps in each section for the cables you need to connect.

Connecting the Computer Cable

Before you start, make sure your projector, computer, and all peripherals are all turned off.

note

If you have an older Macintosh, you may need to use a Macintosh adapter (available from Apple®). Check the documentation for your Macintosh to determine what type of connections are available.

1. Disconnect the monitor cable from the monitor port on the back of your Macintosh.
2. Connect one end of the computer cable to the projector's Computer port.

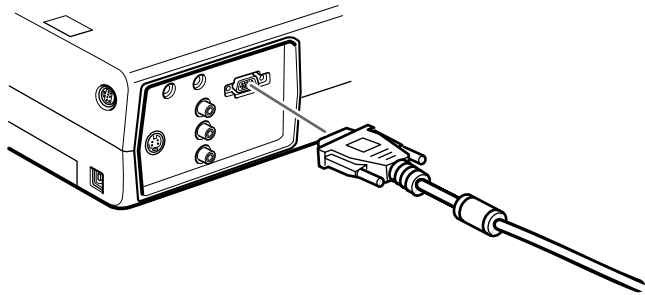

3. Connect the other end to the monitor port on your Macintosh.

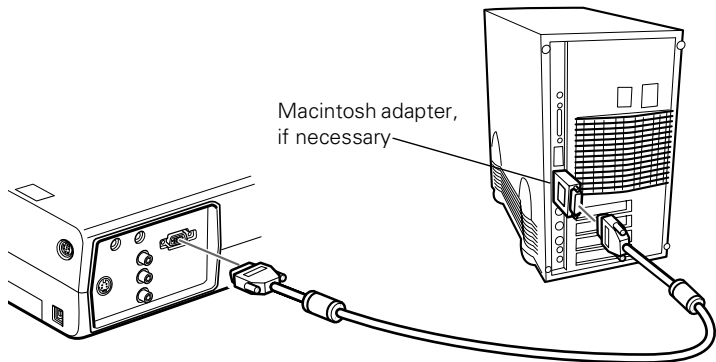

If you can't connect the projector's computer cable to your Macintosh, you may need to use a Macintosh adapter (available from Apple).

- Remove the small cover on the Macintosh adapter and set its DIP switches according to the resolution you want to use (such as 16-inch mode). See your Macintosh documentation for instructions.

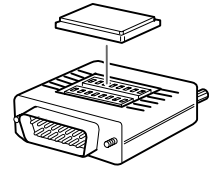

- Connect the small end of the Macintosh adapter to the computer cable.
- Connect the computer cable (with the Macintosh adapter attached) to the monitor port on your Macintosh.

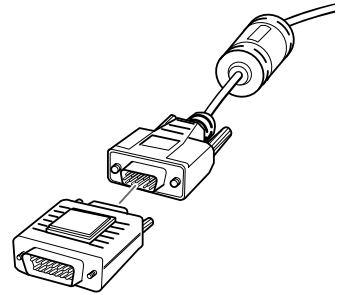

4. Tighten the screws on all the connectors.

If you don't need to make any other connections, you can plug in your projector and turn it on. See page 14 for instructions.

note

If you need maximum volume (in a large auditorium, for example), you can also connect external speakers or a public address system to the projector. See your User's Guide for instructions.

Connecting the Audio Cable

If your presentation includes sound effects or other types of computer audio, you need to connect the audio cable.

1. Connect one end of the audio cable to the **Audio In** jack on the projector.

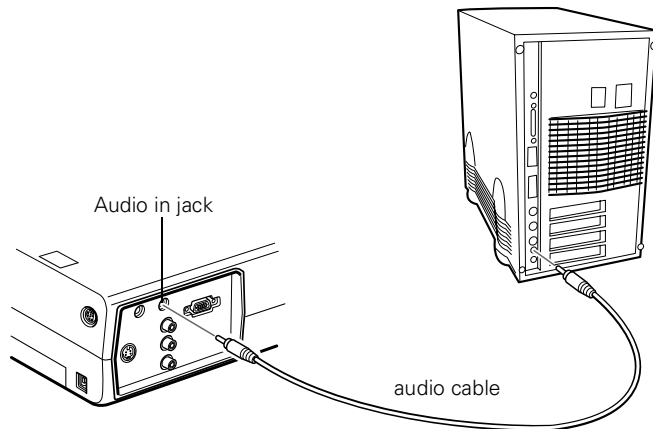

2. Connect the other end of the audio cable to the speaker jack on your Macintosh.

Connecting the Cable for Remote Mouse Control

Using the remote control as a wireless mouse gives you more flexibility. You can deliver your presentation from anywhere in the room and interact with the audience. You don't need to stand near your Macintosh or near the projector.

You'll use different cables and different ports on the projector, depending on what type of mouse your Macintosh has.



1. Determine which type of mouse port your Macintosh has:
 - Round mouse port
 - Flat USB mouse port
2. Connect one end of the appropriate mouse cable to the standard **Mouse/Com** port or the **USB Mouse** port on the projector.

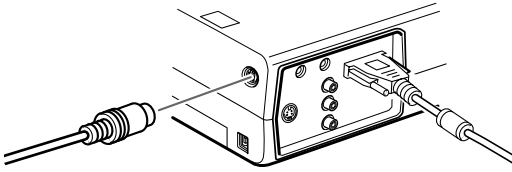

connecting Mac mouse cable

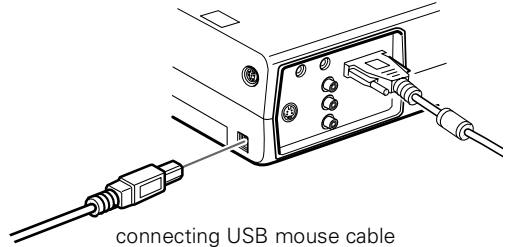

connecting USB mouse cable

3. Connect the other end to the port on your Macintosh.

Turning the Projector On and Off

After you have connected your computer and other equipment, you can plug in the projector and turn it on.

1. Connect the power cable to your projector's power inlet.

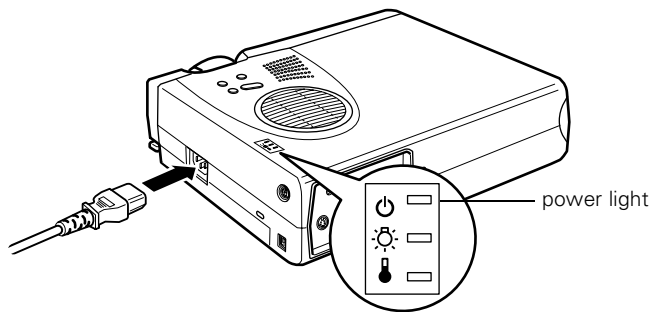

2. Plug the other end of the cable into a grounded electrical outlet.

The power light on top of the projector turns orange. This indicates that the projector is receiving power, but is not yet turned on.

- Use the tab on the lens ring to rotate the ring and pop out the lens.

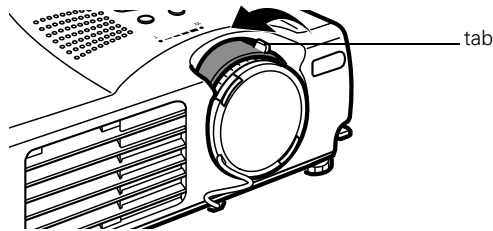

- Squeeze the lens cap tabs and remove the lens cap.

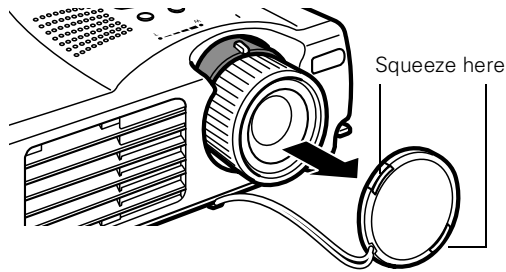

warning

Never look into the lens when the lamp is on. This can damage your eyes, and is especially dangerous for children.

- Press the red Power button on top of the projector.

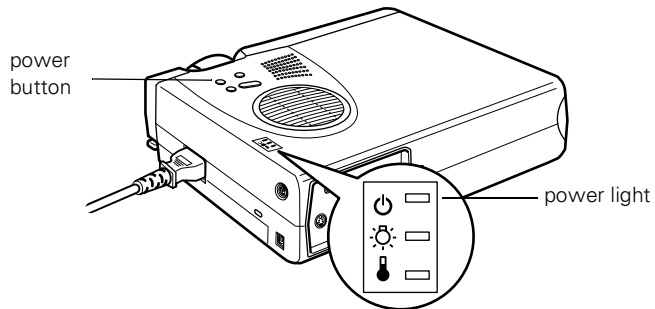

The power light flashes green, and then stays on. You may see a blue screen with the message **No Signal** displayed. This is normal.

- Turn on or restart your computer. In a few moments, you should see the computer display projected.

When you are ready to turn off the projector, follow these steps:

1. Press the red **Power** button on top of the projector. You see a confirmation message. (If you don't want to turn it off, press any other button.)
2. Press the **Power** button again. The Power light flashes orange for about a minute and the fan gets louder as the projector cools down. When the projector has cooled, the orange light stays on and the fan shuts off.

If you want to turn the projector on again, wait until the orange light stops flashing. Then press the **Power** button.

3. When you are finished using the projector, replace the lens cap, retract the lens, and unplug the power cord.

caution

To avoid damaging the lamp, never unplug the power cord when the power light is green.

Turning On Other Equipment

If you're using a VCR, other external video source, or additional equipment with the projector, turn on the equipment in this order:

1. Video source
2. External audio source
3. Projector
4. External speakers or PA system
5. Computer

When you're ready to shut down, turn off the equipment in the reverse order.

B Appendix B: *Using the Projector Menus*

The on-screen menus let you customize and adjust projector features. The following 8 menus and features are available:

- **Video**
Controls the look and quality of the projected image (from a computer or video source).
- **Audio**
Adjusts the volume and tone (treble/bass).
- **Effect**
Customizes the drawing tools available on the remote control.
- **Setting**
Adjusts features such as the keystone setting, blank screen color, message prompt, and power management system.
- **User's Logo**
Lets you capture and store an image to be displayed with the A/V Mute button, or as the startup screen.
- **Advanced**
Controls settings such as menu language, use of startup screen, color temperature, and rear or ceiling projection.
- **About**
Provides information about lamp usage and the current display settings.
- **Reset All**
Restores the factory defaults for all the projector settings.

Changing Menu Settings

You use the **Menu**, **Enter** and **Esc** buttons on the remote control to change menu settings.

To change a menu setting:

1. To access the menu system, open the cover on the lower part of the remote control and press the **Menu** button.

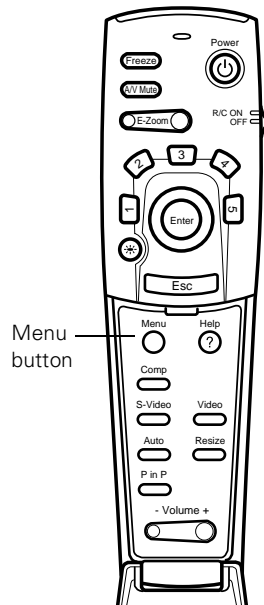

You see the following:

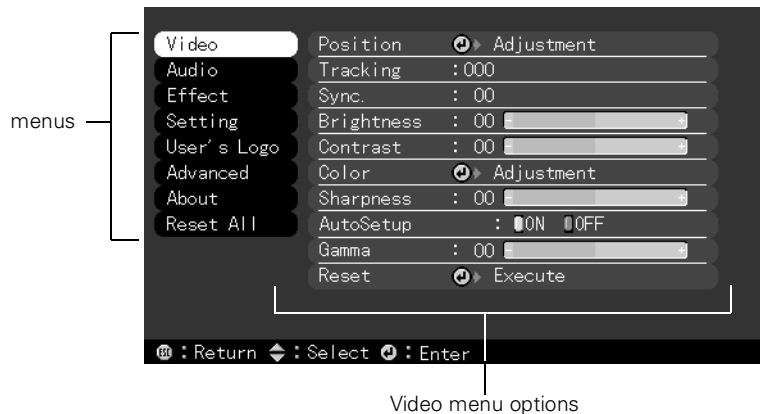

note

The options available in some submenus vary, depending on whether the current image source is the computer or a video source.

As you select a menu, a submenu of options appears to the right.



2. Press the bottom of the **Enter** button (or grasp it between your thumb and finger and tilt it down) to scroll through the menus.

When you highlight a menu, its options are shown on the right.

3. When the menu you want is highlighted, press the center of the **Enter** button to select it.

The highlight moves to the first option for that menu.

4. Press the bottom of the **Enter** button (or grasp it between your thumb and finger and tilt it down) to scroll through the options.
5. Press the right or left side of the **Enter** button (or grasp it between your thumb and finger and tilt it to the side) to change the setting.
6. If you want to go back to the default settings on any menu, select **Reset**, press **Enter**, select **Yes**, and then press **Enter**.
7. Press the **Esc** button on the remote to go back to the main menu display. Your changes are saved automatically.
8. Press the **Menu** button to exit the menu system.

The settings available in each of the menus are described below.

Video Menu (Computer Image Source)

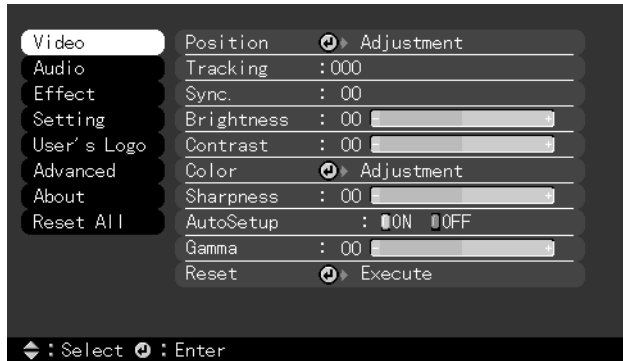

note

Some options are limited to being enabled (turned on) or disabled (turned off).

The computer must be connected and operating, and the image source on the projector must be set to Computer for you to access these menu options.

The Video menu lets you make adjustments to the projected image. The following options are available when the image source is your computer.

Menu item	Description
Position	Use the Enter button to move the screen position in the corresponding direction. When you finish making adjustments, press the Esc button.
Tracking	Matches the projector's internal clock to various computer graphic signals. Adjust this setting to remove vertical lines from the image.
Sync	Synchronizes with the tracking signal sent from the computer. Adjust this setting to correct fuzziness or screen flicker.
Brightness	Lightens or darkens the overall image. Increase brightness to lighten an image, or decrease it to darken the image.
Contrast	Adjusts the difference between light and dark areas. Increase the contrast to make light areas lighter and dark areas darker. Decrease it to minimize the difference between light and dark areas.

Menu item	Description
Color	<p>Adjusts the color balance (red:green:blue) of the input source.</p> <p>Increase the color setting for more intense color on the screen, and lower the setting for less intense color.</p> <p>When you finish making adjustments, press the Esc button.</p>
Sharpness	Adjusts the sharpness of the screen image.
Auto Setup	Set to On to have the computer automatically optimize the image for projection.
Gamma	Adjusts the projected image for natural coloration.
Reset	Returns all menu items to their initial factory defaults.

Video Menu (Video Image Source)

note

The projector's image source must be set to Video, and the video source (such as a VCR or camcorder) must be connected and operating for you to access these menu options. For example, the projector must actually be projecting the image from your video tape if you're using a VCR.

The Video menu lets you make adjustments to the projected image. The following options are available when the image source is Video.

Menu item	Description
Position	Use the Enter button to move the screen position in the corresponding direction. When you finish making adjustments, press the Esc button.
Brightness	Lightens or darkens the overall image. Increase brightness to lighten an image, or decrease it to darken the image.
Contrast	Adjusts the degree of difference between light and dark areas. Increase the contrast to make light areas lighter and dark areas darker. Decrease it to minimize the difference between the lightest and darkest areas of the image.
Color	Adjusts color density. Increase the setting for darker and more opaque colors. Decrease it for lighter and less opaque colors.
Tint (NTSC only)	Adjusts the red-green color balance of the screen. Increase tint to add more green, or decrease it to add more red.
Sharpness	Adjusts the sharpness of the screen image.
Gamma	Adjusts the projected image for natural coloration.
Mode	Specifies the image signal mode: Auto, NTSC, NTSC4.43, PAL, M-PAL, N-PAL, PAL 60, SECAM.
Reset	Returns all menu items to their initial factory defaults.

Audio Menu



Use the Audio menu to adjust the sound volume and quality of your audio.

Menu item	Description
Volume	Adjusts the volume level for the projector's speaker and audio-out terminal. Increase the setting to raise the volume, or decrease it to lower the volume.
Tone	Adjusts the sound quality. Move left to increase bass and right to increase treble.
Reset	Returns all menu items to their initial factory defaults.

Effect Menu



The Effect menu lets you customize the drawing tools available on the remote control.

Menu item	Description
Cursor/Stamp	Selects the stamp you want to use as the cursor graphic and lets you enlarge it.
Box	Selects a box color and shape.
Marker	Selects the marker (horizontal or vertical lines) color and width (from 2 to 32 pixels).
Freehand	Selects the color and width for freehand lines (2 to 148 pixels).
Cursor Speed	Adjusts the cursor speed to Low, Middle, or High.
Reset	Returns all menu items to their initial factory defaults.

Setting Menu

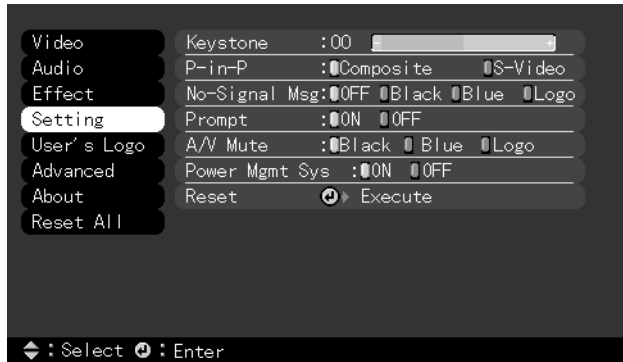

The Setting menu allows you to set or adjust various projector options.

Menu item	Description
Keystone	Adjusts a trapezoid (distorted) image to a 4:3 rectangle, correcting up to a $\pm 15^\circ$ tilt.
P-in-P	Selects the image source (composite or S-Video) for the picture-in-picture subscreen.
No-Signal Msg	Specifies whether no screen, a black screen, a blue screen, or a user logo is displayed when the projector is not receiving a signal.
Prompt	Turns off the message identifying the image source (computer or video).
A/V Mute	Specifies whether a blue, black, or user logo screen is displayed when the A/V mute button is pressed.
Power Mgmt Sys	Turns on the power management system which works with your computer's power management.
Reset	Returns all menu items to their initial factory defaults.

User's Logo Feature

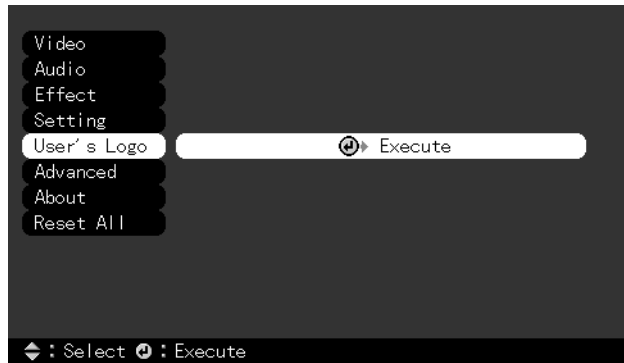

The User's Logo feature allows you to transfer any image on your computer to the projector, and then use it as the screen displayed when the projector is not receiving a signal. You can also set it as a startup screen or to be displayed when you press the A/V Mute button on the remote. The image can be a company logo, slogan, photograph, or another other image you want to use.

Capturing the Image

You start by displaying the image you want to use on the projector. You can use an image from either a computer or video source such as a VCR or digital camera. Then follow these steps to capture the image and transfer it to the projector:

1. Press the **Menu** button. You see the main menu listing, with the **Video** menu highlighted.
2. Press the bottom edge of the **Enter** button (or move it down) to highlight the **User's Logo** menu.

3. Press **Enter** to select this feature. You see the following message:



4. Select **Yes** and press **Enter**. A selection box displays over the image.
5. Use the **Enter** button on the remote control to select the area of the image you want to use. Once you have selected the entire area, press **Enter**.
6. When you see the message "Do you use this image?" select **Yes** and press **Enter**. If you want to change the area selected, select **No** and repeat step 5. You see the following:



7. Use the **Enter** button on the remote control to select a zoom rate (display size), and then press **Enter**.

- When the following message appears, select **Yes** and press **Enter**.



Saving the logo may take a few moments. Do not use the projector or other sources (computer, video, speaker, etc.) while the logo is being saved.

- When you see the following message, press the **Menu** or **Enter** button to redisplay the main menu.



note

You can also set up your image as a startup screen. Use the Advanced menu to enable the startup screen.

Assigning the Image to the No-Signal Message and/or A/V Mute Button

After your image is saved, you can set it up as the no-signal message and/or the screen that's displayed when you press the A/V Mute button.

1. Press the **Menu** button. You see the main menu listing, with the **Video** menu highlighted.
2. Press the bottom edge of the **Enter** button (or tilt it down) to highlight the **Setting** menu.
3. Press the **Enter** button to select the **Setting** menu.
4. Press the bottom edge of the **Enter** button (or tilt it down) to highlight **No-Signal Msg**.
5. Press the right side of the **Enter** button to select **Logo**. This sets your image as the screen displayed when the projector is not receiving a signal.
6. If you want to set up your image as the A/V mute display, press the bottom edge of the **Enter** button (or tilt it down) to highlight **A/V Mute**.
7. Press the right side of the **Enter** button to select **Logo**. This sets your image as the screen displayed when you press the **AV/Mute** button.
8. When you're finished, press **Esc** or **Menu**.

To test your setting, press the **A/V Mute** button to display your image. Press it again to turn off the image.

Advanced Menu

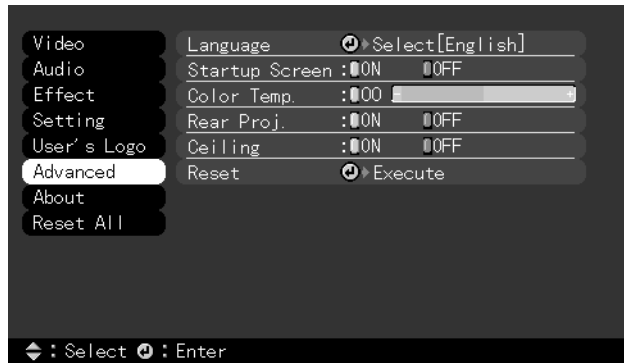

The Advanced menu lets you set additional projector options.

Menu item	Description
Language	Selects the language to be used in the menus: Japanese, English, French, German, Italian, Spanish, Portuguese, Chinese, or Korean.
Startup Screen	Displays the image you have saved as a user logo during the projector's startup.
Color Temp	Adjusts the whiteness of the screen. Positive color temperature values provide a cold white; negative values provide a warmer white.
Rear Proj.	Mirrors the projected image so it looks correct when you're projecting from behind onto a translucent screen. Selecting ON turns mirroring on, while OFF turns it off (for a normal image).
Ceiling	Flips the projected image so it looks correct when the projector is mounted upside-down from the ceiling. Selecting ON turns the feature on, while OFF turns it off (for a normal image).
Reset	Returns all Advanced menu items to their initial factory defaults.

About Menu (Computer Image Source)

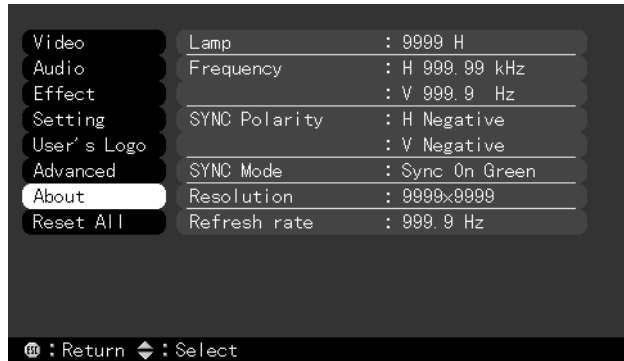

When the image source is a computer, the About menu displays information about the projector's horizontal and vertical frequency, lamp hours, and computer connection.

Menu item	Description
Lamp	Displays the number of hours the current lamp has been used.
Frequency	Displays the projector's horizontal and vertical frequency.
Sync Polarity	Displays the sync polarity of the computer.
Sync Mode	Displays the sync mode of the computer.
Resolution	Displays the output resolution of the computer video output.
Refresh Rate	Displays the refresh rate of the computer video output.

About Menu (Video Image Source)

When the image source is video, the About menu displays information about the projector's lamp hours and video signal.

Menu item	Description
Lamp	Displays the number of hours the current lamp has been used.
Video Signal	Displays the input image signal mode.

Reset All Feature

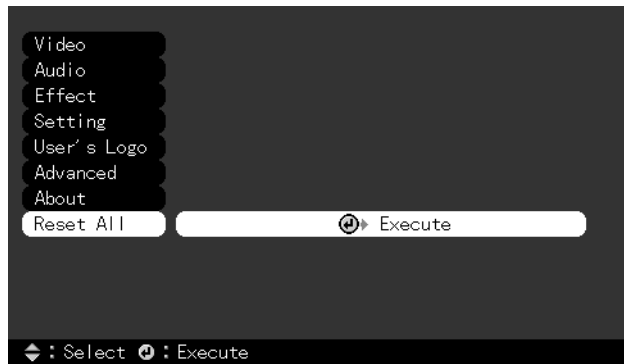

The Reset All feature lets you return all the projector settings to their default values. It does not change or delete any user logo you have stored.

Select **Reset All** and press the **Enter** button to display the confirmation screen. Select **Yes** to reset all the default settings or **No** to cancel.

C

Appendix C: Technical Specifications

General	Type of display	Poly-silicon Thin Film Transistor (TFT)
	Size of liquid crystal panels	Diagonal: 0.9 inch (22.9 mm)
	Lens	F=2.0–2.2, f=35–42 mm
	Resolution	500c: 800 × 600 pixels 700c: 1024 × 768 pixels 710c: 1024 × 768 pixels
	Color reproduction	24 bit, 16.7 million colors
	Brightness	500c: 800 lumens (ANSI) 700c: 800 lumens (ANSI) 710c: 1000 lumens (ANSI)
	Image size (diagonal)	2.2 to 25 feet (0.7 to 7.6 meters)
	Projection distance	3.6 to 45.3 feet (1.1 to 13.8 meters)
	Projection methods	Front, rear, upside-down (ceiling mount)
	Internal speaker system	1 monaural
	Optical aspect ratio	4:3 (horizontal:vertical)
	Zoom ratio	1.2:1
	Keystone correction angle	±15°
	Supported video interface standards	NTSC, NTSC4.43, PAL, PAL-M, PAL-N, PAL60, SECAM

Projection Lamp	Type	UHE (Ultra High Efficiency)
	Power consumption	120 W
	Lamp life	About 2000 hours
	Part number	ELPLP10S (710c) ELPLP10B (500c, 700c)
Remote Control	Range	32.8 feet (10 meters)
	Batteries	Alkaline AA (2)
Mouse Compatibility	Supports PS/2, USB, Macintosh	
Remote IR Receiver	Supports EPSON Remote IR Receiver, 10-foot cable (typical use for rear screen projection)	
Mechanical	Height	2.8 to 3.0 inches (72 to 77 mm)
	Width	8.4 inches (213 mm)
	Depth	10.5 inches (267 mm)
	Weight	5.8 lb (2.6 kg)
Electrical	Rated frequency	50/60 Hz
	Power supply	100 to 120 VAC, 2.4 A 200 to 240 VAC, 1.2 A
	Power consumption	Operating: 360 W Standby: 12 W
Environmental	Temperature	Operating: 41 to 104° F (5 to 40° C), non-condensing Storage: 14 to 140° F (-10 to 60° C), non-condensing
	Humidity	Operating: 20 to 80% RH, non-condensing Storage: 10 to 90% RH, non-condensing

Safety	United States	FCC Part 15J Class B UL1950 Rev. 3
	Canada	DOC SOR/88-475 CSA C22.2 No. 950 Rev. 3
CE Marking		Directive 89/336/EEC EN 55022 Class B EN 50082-1
		Directive 73/23/EEC EN 60950

Supported Monitor Displays The following table lists the display formats supported by the projector:

Mode	Resolution	Frequency H(KHz)/V(Hz)	Dot (MHz)
VGACGA VGAEGA	640 x 400 640 x 350	31.46 / 70 31.46 / 70	25.175 25.175
NEC400	640 x 400	24.83 / 56.65	21.053
VGA60 VGA72 VGA75 VGA85	640 x 480 640 x 480 640 x 480 640 x 480	31.469 / 59.94 37.861 / 72.809 37.5 / 75 48.269 / 85.008	25.175 31.5 31.5 36
SVGA56 SVGA60 SVGA72 SVGA75 SVGA85	800 x 600 800 x 600 800 x 600 800 x 600 800 x 600	35.156 / 56.25 37.879 / 60.317 48.077 / 72.188 46.875 / 75 53.674 / 85.061	36 40 50 49.5 56.25
XGA43i XGA60 XGA70 XGA75 XGA85	1024 x 768 1024 x 768 1024 x 768 1024 x 768 1024 x 768	35.522 / 86.958 48.363 / 60.004 56.476 / 70.069 60.023 / 75.029 68.677 / 84.997	44.9 65 75 78.75 94.5
SXGA1_70 SXGA1_75 SXGA1_85	1152 x 864 1152 x 864 1152 x 864	63.851 / 70.012 67.5 / 75 77.094 / 84.999	94.5 108 121.5
SXGA2_60 SXGA2_75 SXGA2_85	1280 x 960 1280 x 960 1280 x 960	60 / 60 75 / 75 85.938 / 85.002	108 126 148.5

Mode	Resolution	Frequency H(KHz)/V(Hz)	Dot (MHz)
SXGA3_43i SXGA3_60 SXGA3_75 SXGA_85	1280 x 1024 1280 x 1024 1280 x 1024 1280 x 1024	46.433 / 86.871 63.981 / 60.02 79.976 / 75.025 91.146 / 85.024	78.75 108 135 157.5
UXGA48i UXGA60 (these are not supported by PowerLite 500c)	1600 x 1200 1600 x 1200	62.5 / 96.08 75 / 60	135 162
MACLC13 MACII13 MAC16 MAC19-60 MAC19 MAC21	640 x 480 640 x 480 832 x 624 1024 x 768 1024 x 768 1152 x 870	34.975 / 66.62 35 / 66.67 49.725 / 74.55 48.193 / 59.28 60.241 / 74.93 68.682 / 75.062	31.33 30.24 57.28 64 80 100
NTSC (SXGA) NTSC (XGA)	1366 x 438 1024 x 438	15.734 / 60	28.486 20.890
PAL (SXGA) PAL (XGA)	1366 x 512 1024 x 512	15.625 / 50	28.846 21.154
SECAM (SXGA) SECAM (XGA)	1366 x 512 1024 x 512	15.625 / 50	28.846 21.154

Note: The frequencies of some computers may not allow the image to be displayed correctly.

Computer Connector Pin Assignments

The Computer port is a female video RGB, 15-pin micro-D-style connector. Here are the pin assignments:

Input pin	Computer connector signals
1	Red video
2	Green video
3	Blue video
4	GND
5	GND
6	Red video GND
7	Green video GND
8	Blue video GND
9	Reserve
10	Synchronous GND
11	GND
12	SDA
13	Horizontal sync/composite sync
14	Vertical sync
15	SCL

Index

A

- A/V Mute Button, 29
- About menu, 31 to 32
- Advanced menu, 30
- Audio
 - connecting desktop, 9, 13
 - menu, 23

B

- Brightness, 33
- Brightness setting, 20, 22
- Buttons, remote control, 18 to 19

C

- Camcorder, adjusting the projected image, 22
- CE Marking, 35
- Ceiling, hanging the projector from, 30
- Color setting, 21, 22
- Color Temp setting, 30
- Computer connector pin assignments, 37
- Computer, adjusting projected image for, 20
- Connecting projector
 - to a desktop Macintosh, 10 to 14
 - to a desktop PC, 7 to 9
- Contrast setting, 20, 22

D

- DIP switches, 12
- Display formats, supported, 35 to 36
- Distance from projector to screen, 5 to 6
- Drawing tools, 24

E

- Effect menu, 24
- Electrical specifications, 34
- Environmental specifications, 34 to 35

F

- Formats, supported display, 35 to 36

G

- Gamma setting, 21, 22

H

- Humidity requirements, 34

I

- Image
 - adjusting position, 20, 22
 - adjusting quality, 20 to 22
 - size range, 6, 33
- Image signal mode, 22

K

- Keystone setting, 25

L

- Lamp specifications, 34
- Language setting, 30
- Lumens, 33

M

Macintosh, connecting projector to, 10 to 14

Mechanical specifications, 34

Menus

- About, 31 to 32

- Advanced, 30

- Audio, 23

- changing settings, 18 to 19

- Effect, 24

- Reset All, 32

- Setting, 25

- User's Logo, 26

- Video, 20 to 22

Monitors, supported, 35 to 36

P

Picture-in-picture option, 25

Pin assignments, connector, 37

Positioning the projector, 5 to 6

Positioning the screen image, 20, 22

Power

- consumption, 34

- management, 25

- supply, 34

Projector

- distance to screen, 6

- hanging from the ceiling, 30

- lamp specifications, 34

- positioning, 5 to 6

- positioning the screen image, 20, 22

- setting up, 5

- turning off, 16

- turning on, 14

R

Rear projection, 30

Remote control

- buttons, 18 to 19

- specifications, 34

Reset All feature, 32

Resolution, 33

S

Setting menu, 25

Sharpness setting, 21, 22

Speakers, adjusting sound, 23

Specifications

- electrical, 34

- environmental, 34 to 35

- general, 33

- lamp, 34

- mechanical, 34

- remote control, 34

- safety, 35

Startup screen, 30

Sync setting, 20

T

Temperature requirements, 34

Tint setting, 22

Tone setting, 23

Tracking setting, 20

Turning off the projector, 16

Turning on additional equipment, 16

Turning on the projector, 14

U

User's Logo feature, 26

V

VCR, adjusting the projected image, 22

Video

- adjusting the projected image, 22

- menus, 20 to 22

Volume setting, 23

Z

Zoom ratio, 33

EPSON® PowerLite® 500c/700c/710c Multimedia Projector



User's Guide

Important Safety Information

WARNING: Never look into the projector lens when the lamp is turned on; the bright light can damage your eyes. Never let children look into the lens when it is on. Never open any cover on the projector, except the lamp and filter covers. Dangerous electrical voltages inside the projector can severely injure you. Except as specifically explained in this *User's Guide*, do not attempt to service this product yourself. Refer all servicing to qualified service personnel.

WARNING: The projector and its accessories come packaged in plastic bags. Keep plastic bags away from small children to avoid any risk of suffocation.

Caution: When you replace the lamp, never touch the new lamp with your bare hands; the invisible residue left by the oil on your hands may shorten the lamp life. Use a cloth or glove to handle the new lamp.

Copyright Notice

All rights reserved. No part of this publication may be reproduced, stored in a retrieval system, or transmitted in any form or by any means, electronic, mechanical, photocopying, recording, or otherwise, without the prior written permission of SEIKO EPSON CORPORATION. The information contained herein is designed only for use with this EPSON printer. EPSON is not responsible for any use of this information as applied to other printers.

Neither SEIKO EPSON CORPORATION nor its affiliates shall be liable to the purchaser of this product or third parties for damages, losses, costs, or expenses incurred by purchaser or third parties as a result of: accident, misuse, or abuse of this product or unauthorized modifications, repairs, or alterations to this product, or (excluding the U.S.) failure to strictly comply with SEIKO EPSON CORPORATION's operating and maintenance instructions.

SEIKO EPSON CORPORATION shall not be liable for any damages or problems arising from the use of any options or any consumable products other than those designated as Original EPSON Products or EPSON Approved Products by SEIKO EPSON CORPORATION.

EPSON is a registered trademark of SEIKO EPSON CORPORATION.

EPSON SoundAdvice and EPSON PrivateLine are service marks, EPSON FaxAdvice and SizeWise are trademarks, and PowerLite is a registered trademark of Epson America, Inc.

General Notice: Other product names used herein are for identification purposes only and may be trademarks of their respective owners. EPSON disclaims any and all rights in those marks.

C

Contents

Welcome

Tips for Powerful Presentations	2
Getting More Information	3
Warnings, Cautions, and Notes	4
Registering	4
Reading Your Electronic Manuals	4

Getting Started

Unpacking the Projector	8
Installing Batteries in the Remote Control	9
Positioning the Projector	9
Choosing Your Connections	11
Connecting to a PC Laptop	12
Connecting the Computer Cable	12
Connecting the Audio Cable	13
Connecting the Cable for Remote Mouse Control	14
Connecting to a PowerBook	15
Connecting the Computer Cable	15
Connecting the Audio Cable	17
Connecting the Cable for Remote Mouse Control	17
Connecting to a Video Source	19
Connecting Standard Video Cables	19
Connecting S-Video Cables	20
Connecting to External Speakers or a PA System	21
Turning the Projector On and Off	22
Turning On Other Equipment	24

Projecting a Presentation

Displaying Your Image	26
Adjusting Your Image	28
Focusing and Zooming Your Image	28
Positioning Your Image	29
Adjusting the Image Shape	30
Using the Remote Control	30
Operating the Projector with the Remote Control	31
Using the Remote Control as a Wireless Mouse	32
Zooming Your Image with the Remote	33
Resizing Your Image	33
Turning Off the Picture	34
Working with Audio and Video	34
Selecting Your Video Source	34
Stopping Action	35
Adjusting Sound Volume	35
Displaying Picture in Picture Video	35
Drawing on the Screen	36
Using the Cursor/Stamp Arrow	37
Drawing Boxes	37
Drawing Horizontal and Vertical Lines	38
Drawing Freehand Lines	39
What To Do When the Lights Flash	40
Using the On-Screen Help	41
Shutting Down the Projector	42

Fine-Tuning Your Projector

Using the Menus	46
Changing Menu Settings	47
Adjusting the Image	48
Repositioning the Image	48
Adjusting Image Appearance	49
Adjusting Image Color	49
Adjusting the Sound	50
Customizing the Drawing Tools	51
Customizing the Cursor/Stamp	52
Customizing the Box, Line and Marker Tools	53
Customizing Projector Features	54

	Creating Your Own Startup Screen	56
	Capturing the Image	56
	Assigning the Image to the No-Signal Message and/or A/V Mute Button	57
	Viewing Information	58
<i>Maintaining and Transporting the Projector</i>	Cleaning the Lens	60
	Cleaning the Projector	60
	Cleaning the Air Filter	61
	Replacing the Lamp	62
	Transporting the Projector	64
<i>Solving Problems</i>	Projector Operation Problems	65
	Problems with the Remote Control	67
	Image or Sound Problems	68
	Where To Get Help	71
	Telephone Support Services	72
<i>Notices</i>	Important Safety Instructions	73
	Remote Control Information	75
	Declaration of Conformity	76
	FCC Compliance Statement	77
<i>Index</i>	Index	79

W *Welcome*

Your EPSON® PowerLite® is the smallest, most lightweight projector to offer powerful 3-LCD performance. It weighs less than 6 pounds and displays full-color images at a resolution of 1024 × 768 pixels (PowerLite 700c/710c) or 800 × 600 pixels (PowerLite 500c).

Producing up to 1000 ANSI lumens, your projector creates bright images that can be easily seen in rooms light enough to take notes. Digital keystone correction, picture-in-picture technology, and electronic zoom are some of the advanced features of your projector.

You can connect it simultaneously to two image sources: a computer and a video device, such as a VCR, DVD player, laser disc player, camcorder, or digital camera. You can also connect audio for each image source.

You operate your projector through a hand-held remote control, with buttons for zooming in on your image, adjusting volume, and accessing all the projector's features. You can also use the remote control as a wireless mouse, and run your presentation as you move around the room.

EPSON's SizeWise™ technology supports a range of computer outputs, for a full-size image from just about any notebook PC or PowerBook.® If you use a VCR or other video source, the projector automatically senses the video format, so you can use it with confidence no matter where in the world you travel.

The EPSON PrivateLineSM Technical Support program will get you help when you need it. A special 800 number and your own PIN will connect you with a projector support specialist—fast.

Tips for Powerful Presentations

Your PowerLite projector gives you all the tools you need to give a professional presentation. But you still have to prepare your materials and practice your delivery. Here are some tips that should help:

- **Get the facts.**

What is the purpose of the presentation? Who will be in the audience? How long will you have for your presentation? How big is the room? See Chapter 1 for tips on the best way to set up the projector based on room size.

- **Focus your content.**

Try to narrow down the subject matter so you can deliver exactly what your audience is expecting. Determine what action you want your audience to take—are you selling them a product or an idea? Make sure you do the research required to sound like an expert.

- **Develop effective visuals.**

Studies show that visuals are the best way to reach your audience and help them retain your message. Make sure you know how to use your presentation software effectively. Using the templates that come with most presentation packages will ensure that the colors, layout, type fonts, and other elements work together.

- **Practice.**

When it comes to presentations, practice makes perfect. The better prepared you are, the less nervous you'll be, and the more you'll come across as an authority. Using your projector and remote control will be easy with a little practice. See Chapter 2 for instructions.

- **Prepare for takeoff.**

Make sure you have all the equipment you need before you leave. There's nothing more frustrating than discovering at the last minute that a cable is missing or your remote control batteries ran out. See the back of your *Start Here* folder for a checklist of take-along items.

Getting More Information

Need more tips on giving presentations? Quick steps for setting up your projector? Here's where you can look for help:

- **www.presentersonline.com**
Includes a library of articles covering presentation tips, tricks, and technology. Provides templates, clip art and sound clips, as well as Presenters Services to use on the road. Even more resources and services are available if you register to join the Presenters Club—and it's free.
- **www.epson.com/support**
Download FAQs and e-mail your questions to EPSON's technical support team.
- **Start Here folder**
Contains your *Quick Setup* sheet, warranty brochure, CD-ROM, and EPSON PrivateLine Support card. Store this *User's Guide* in the folder and keep the folder with your projector at all times.
- **Quick Setup sheet**
Gives you all the instructions you need to get your PowerLite set up and connected to a laptop or PowerBook computer.
- **CD-ROM**
Lets you register electronically. Also includes the electronic version of this *User's Guide*, plus the *User's Guide Supplement*, which contains specifications, instructions for connecting to a desktop PC or Macintosh,[®] and more. You can copy the *User's Guide* and *Supplement* to your notebook computer and have them handy wherever you go. See page 4 for instructions on using them.

If you still need help after checking this *User's Guide* and the sources listed above, you can use the EPSON PrivateLine Support service to get help fast. Call 1-800-637-7661 and enter the PIN on your card. Or take advantage of EPSON's automated support services 24 hours a day. See pages 71 and 72 for more information.

Warnings, Cautions, and Notes

Please follow these guidelines as you read this manual:

warning

caution

note

- Warnings must be followed carefully to avoid bodily injury.
- Cautions must be observed to avoid damage to your equipment.
- Notes contain important information about your projector.

Registering

Please take a minute to register online using the CD-ROM that came with your EPSON PowerLite projector. This enables you to receive special information on accessories, new products, and services. You can register through the Internet, by e-mail or 800-number modem connection, or by printing out the form to fax or mail.

Reading Your Electronic Manuals

To read your electronic manuals, you'll use Adobe® Acrobat® Reader. If you have Acrobat Reader 3.0 or higher already installed on your computer, you can double-click *User'sGuide.pdf* to read the *User's Guide*, or *Supplement.pdf* to read the *User's Guide Supplement*. If not, install Acrobat Reader from the CD-ROM.

You can also copy the electronic manuals to your computer and have them handy to read whenever you want.

When you open an electronic manual, you'll see this toolbar:

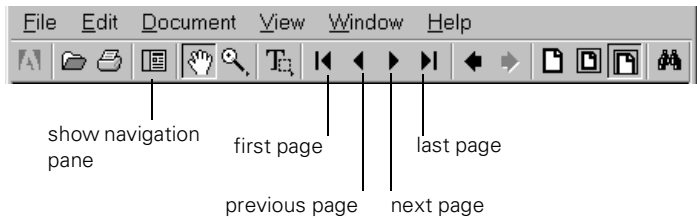

With Acrobat Reader, you have several ways to navigate through text:

- Use the navigation pane on the left side of the screen to move quickly to the topic of your choice.
- Use the arrow buttons in the toolbar or the vertical scroll bar on the right side of the document to move through a manual. (The box to the left of the scroll bar displays the current page number.)
- When your mouse pointer changes from a hand to a pointing finger, you can click to jump to a related topic.

For more information, see your Acrobat Reader online guide.

1 *Getting Started*

This chapter tells you how to unpack your projector, set it up for a presentation, connect it to a computer and/or video source, and turn it on. A lot of this information also appears on the *Quick Setup* sheet that came with the projector. You'll find more detailed information and additional instructions in this chapter, including:

- Unpacking the projector
- Installing batteries in the remote control
- Positioning the projector
- Choosing your connections
- Connecting to a PC laptop
- Connecting to a PowerBook
- Connecting to a video source
- Connecting to external speakers or a PA system
- Turning the projector on and off

Unpacking the Projector

Make sure you have all the parts shown:

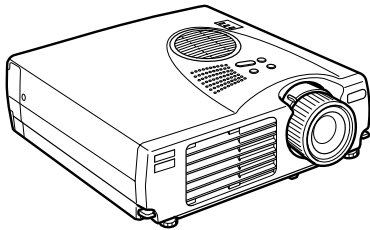

projector



remote control



batteries

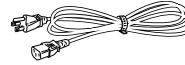

power cord

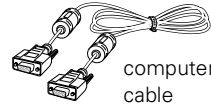

computer cable

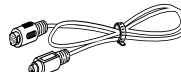

PS/2 mouse cable

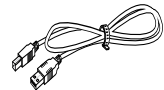

USB mouse cable



AV cable

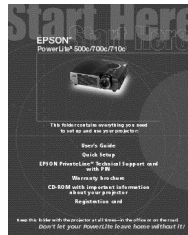

information packet



computer audio cable

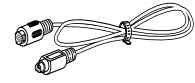

Macintosh mouse cable

Save all packaging in case you need to ship the projector.

Always use the original packaging (or the equivalent) when you need to send the projector to another location.

If you are moving the projector by hand, use a carrying case (either a case available from EPSON or something similar, such as a laptop case).

caution

When replacing batteries, take the following precautions:

Do not mix old and new batteries.

Replace batteries as soon as they run out. If the batteries leak, wipe away battery fluid with a soft cloth. If fluid gets on your hands, wash them immediately.

Remove batteries if you will not be using the remote for a long period of time.

Installing Batteries in the Remote Control

The remote control operates the projector and lets you access its setup menus. You can also run your presentation with the remote and use it as a wireless mouse.

Follow these steps to install the batteries:

1. Slide off the battery compartment cover.

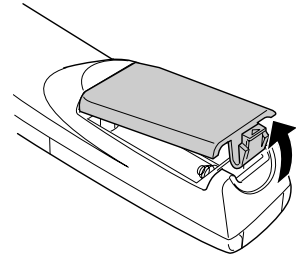

2. Insert the two AA batteries included with the projector as shown.

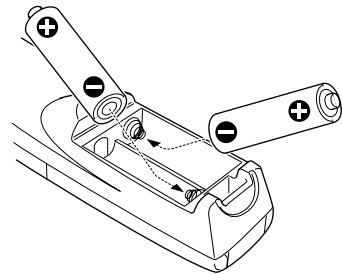

3. Replace the battery compartment cover.

Positioning the Projector

Before you can set up the projector, you need to decide where to place it. The location you choose depends on the size of the audience (and room) and your presentation style.

- Place the projector on a sturdy, level surface, between 3.5 and 45 feet from the screen.
- Make sure the projector is within 10 feet of a grounded electrical outlet or extension cord.
- Place the computer and/or video source within 5 feet of the projector.
- Make sure the projector is perpendicular to the screen. Otherwise, your image will be distorted.

The distance from the projector to the screen determines the actual size of the projected image, as shown:

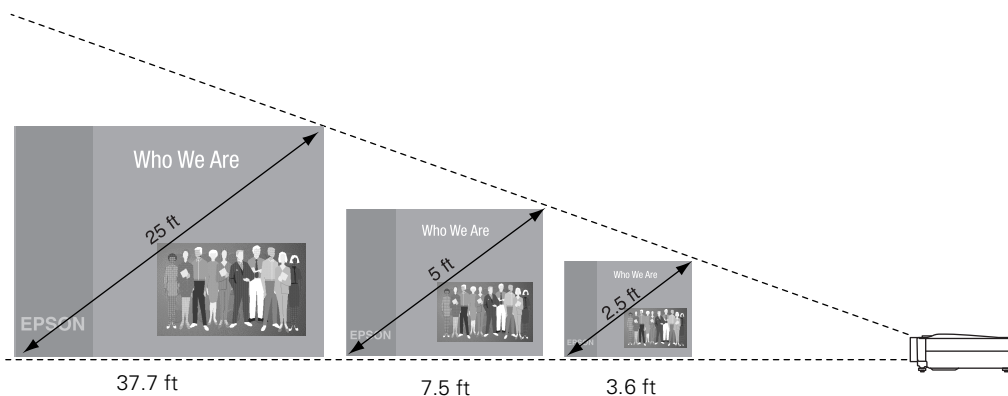

note

It is easier to position the projector when the screen is directly in front of the room. If the screen is placed diagonally in a corner, it is much more difficult to position the projector perpendicular to the screen and get a non-distorted image.

Most presenters find it convenient to place the projector (and computer) in the front of the room. With this arrangement, the projector is placed close to the screen. You need to raise the front of the projector (by extending the legs) in order to position the image high enough on the screen. Then you can use the projector's keystone function to correct the distortion caused by tilting up the front of the projector.

An ideal arrangement is to have the screen placed on the front wall and allow as much space as possible between the screen and the audience. This will let you move close to your audience and still place the projector far enough from the screen to get a good-sized image.

Choosing Your Connections

The connections you'll need to make depend on the equipment you're using, whether your presentation includes sound, and whether you plan to use the remote to run your presentation.

note

You can also connect your projector to a desktop computer or Macintosh. For instructions, see the electronic User's Guide Supplement on the projector CD-ROM.

- **Computer connection**

For many presentations, the only connection you'll need is between your computer and the projector. To connect a PC laptop, see page 12. To connect a Macintosh PowerBook, see page 15.
- **Remote control connection**

To use the remote control as a wireless mouse, you'll need to connect the mouse cable. When you use the remote, you can locate the projector (and computer) far enough from the screen to get a large image, without worrying about where you will stand. You can move around the room and interact with your audience, while still controlling your presentation.
- **Sound connections**

If your presentation includes "computer audio" or sound effects, you'll need to connect the audio cable. This lets you use the projector's speaker instead of the speaker in your laptop. If you need more amplification, you can also connect external speakers or a public address system to the projector.
- **Video connections**

You can connect a VCR, camcorder, laser disc player, DVD player, digital camera, or any other video source to your projector. You can connect the video source and a computer at the same time, and easily switch between sources.

note

Laptop configurations vary. See your manual if you're not familiar with the ports on your laptop.

2. Connect the other end of the cable to your laptop's video (monitor) port.

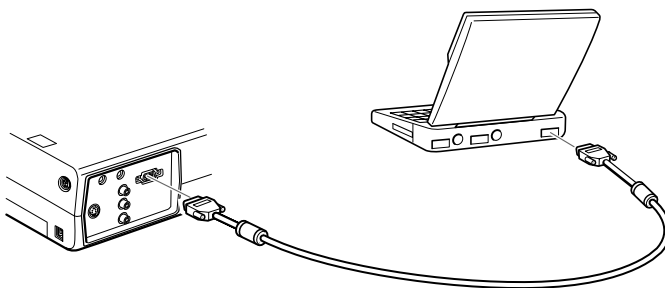

3. Tighten the screws on all connectors.

If you don't need to make any other connections, you can plug in your projector and turn it on. See page 22 for instructions.

You may need to set the display to appear on both the laptop's screen and the projector. Some laptops let you change this setting with the function keys or by using a setup utility provided by the computer manufacturer. Check your laptop's manual or online help for instructions.

note

If you need maximum volume (in a large auditorium, for example), you can also connect external speakers or a public address system to the projector. See page 21 for instructions.

Connecting the Audio Cable

If your presentation includes sound effects or other types of computer audio, you need to connect the audio cable.

1. Connect one end of the audio cable to the Audio In jack on the projector.

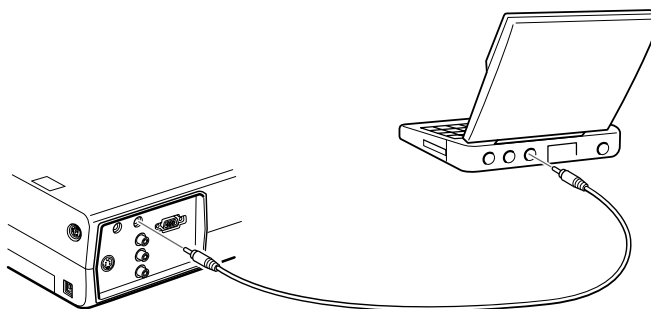

2. Connect the other end to the laptop's  headphone jack.

Connecting the Cable for Remote Mouse Control

Using the remote control as a wireless mouse gives you more flexibility. You can deliver your presentation from anywhere in the room and interact with the audience. You don't need to stand near your computer or near the projector.

You'll use different cables and different ports on the projector, depending on whether your laptop has a round PS/2 mouse port or a flat USB mouse port.

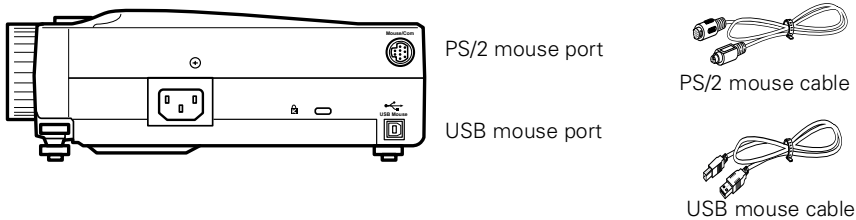

1. Determine which type of mouse port your laptop has:
 - Round PS/2 mouse port
 - Flat USB mouse port
2. Connect one end of the appropriate mouse cable to the PS/2 Mouse/Com port or the USB Mouse port on the projector.

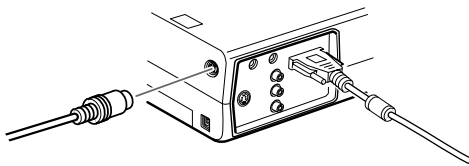

connecting PS/2 mouse cable

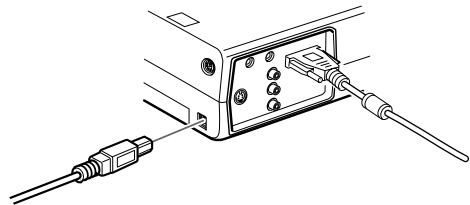

connecting USB mouse cable

3. Connect the other end to the external mouse port on your laptop.
4. If necessary, configure your laptop to work with an external mouse.

Connecting to a PowerBook

You can connect your projector to any PowerBook that supports an external monitor.

This section includes instructions for the following:

- Connecting the computer cable
- Connecting the audio cable
- Connecting the mouse cable for remote mouse control

note

If you have an older PowerBook, you may need to use a Macintosh adapter and a special video-out cable (both available from Apple®). Check the documentation for your PowerBook to determine what type of connections are available.

Connecting the Computer Cable

Before you start, make sure your PowerBook and the projector are turned off.

1. Connect one end of the computer cable to the projector's Computer port.

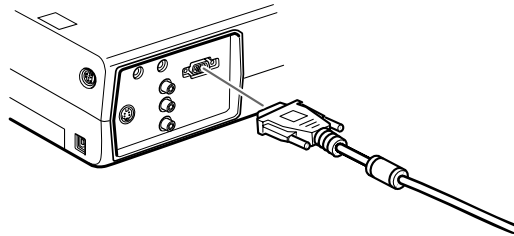

2. Connect the other end to your PowerBook's  monitor port.

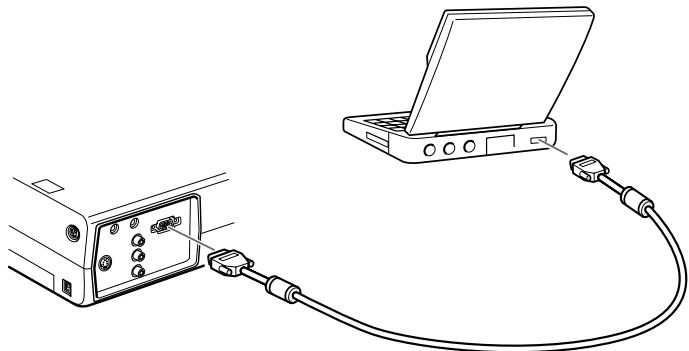

If you can't connect the projector's computer cable to your PowerBook, you may need to use a Macintosh adapter (available from Apple).

- Remove the small cover on the Macintosh adapter and set its DIP switches according to the resolution you want to use (such as 16-inch mode). See your PowerBook documentation for instructions.

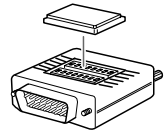

- Connect the small end of the Macintosh adapter to the computer cable.
- Connect the computer cable (with the Macintosh adapter attached) to the video-out port on your PowerBook.

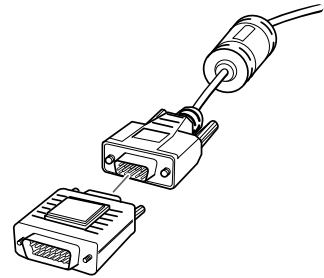

If your PowerBook requires a video-out cable, connect the smaller end of the video-out cable to the video-out port on the back of the PowerBook. Connect the other end to the Macintosh adapter on the end of the computer cable.

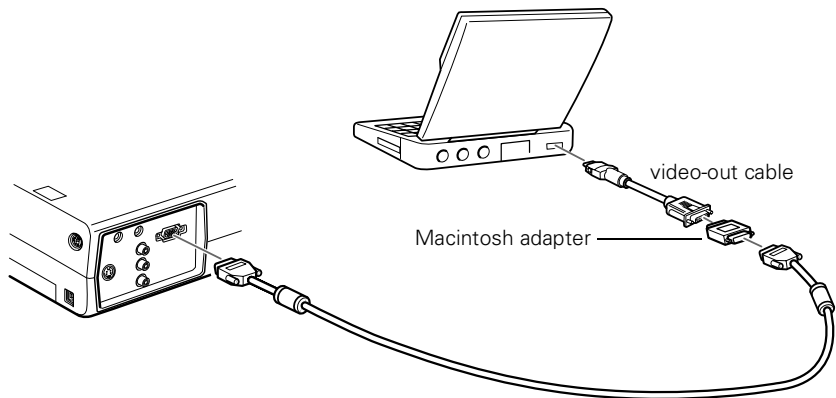

3. Tighten the screws on all connectors.

If you don't need to make any other connections, you can plug in your projector and turn it on. See page 22 for instructions.

After you turn on the projector and computer, you'll need to choose **Mirroring** in the Display Control Panel of your PowerBook if you want to display on the LCD screen as well as the projector screen.

note

If you need maximum volume (in a large auditorium, for example), you can also connect external speakers or a public address system. See page 21 for instructions.

Connecting the Audio Cable

If your presentation includes sound effects or other types of computer audio, you need to connect the audio cable.

1. Connect one end of the audio cable to the **Audio In** jack on the projector.

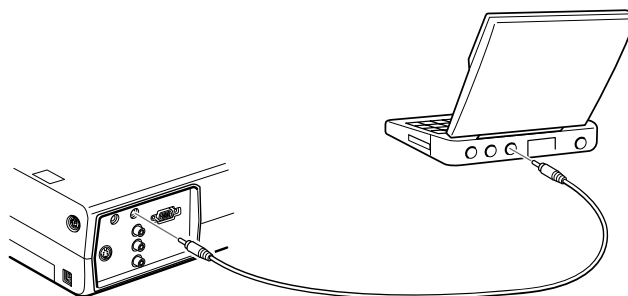

2. Connect the other end to the  audio out jack on your PowerBook.

Connecting the Cable for Remote Mouse Control

Using the remote control as a wireless mouse gives you more flexibility. You can deliver your presentation from anywhere in the room and interact with the audience. You don't need to stand near your PowerBook or near the projector.

You'll use different cables and different ports on the projector, depending on what type of port your PowerBook has.

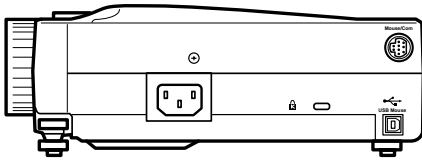

standard
mouse port

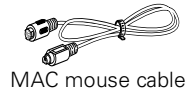

MAC mouse cable

USB mouse port

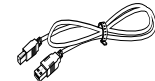

USB mouse cable

1. Determine which type of mouse port your PowerBook has:
 - Round mouse port
 - Flat USB port
2. Connect one end of the mouse cable to the standard **Mouse/Com** port or the **USB Mouse** port on the projector.

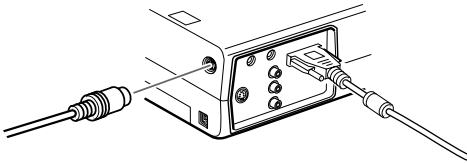

connecting MAC mouse cable

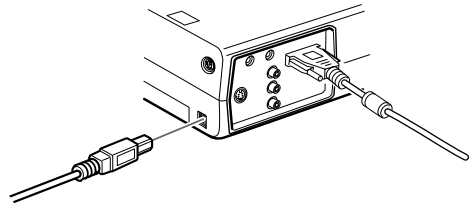

connecting USB mouse cable

3. Connect the other end to the port on your PowerBook.

Connecting to a Video Source

You can connect a VCR, camcorder, laser disc player, DVD player, digital camera, or any other video source to your projector. You can connect the video source and a computer at the same time, and easily switch between sources. The projector supports NTSC, PAL, and SECAM video formats, and automatically detects the one you're using.

note

You can't use the projector with a cable TV-style F connector.

A standard RCA A/V cable is included with the projector. If your video source also has an S-video jack (as shown with an S-video plug at the right), you can use it to provide a higher quality video image. However, you'll need an S-video cable, which may be included with your video source, or may be purchased from an electronics store or video dealer.



Connecting Standard Video Cables

Before you start, make sure the projector and your VCR or other video source are turned off.

1. Connect the yellow plug on one end of the A/V cable to the projector's yellow Video jack.
2. Connect the other yellow plug to the video-out jack on your video source.
3. Connect the A/V cable to the left and right Audio jacks on the projector, matching the red and white plugs to the red and white jacks.

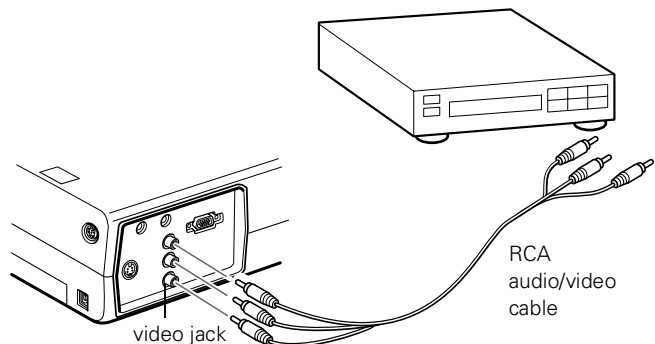

4. Connect the red and white plugs at the other end of the cable to the corresponding audio output jacks on your video source.

Connecting S-Video Cables

If your video source supports S-video, and you have an S-video cable, follow these instructions. Before you start, make sure the projector and your VCR or other video source are turned off.

1. Insert one end of an S-video cable into the projector's **S-Video** connector.

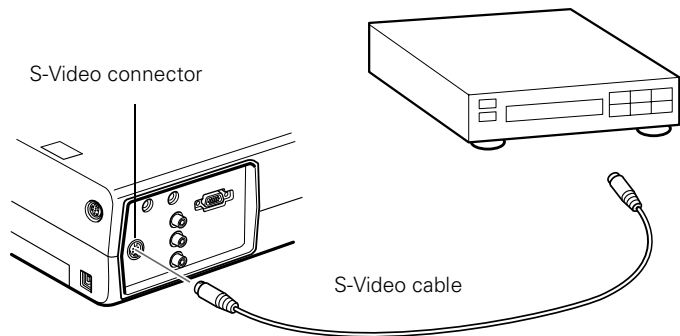

2. Insert the other end into the S-video-out jack of your video source.
3. Connect the A/V cable to the left and right **Audio** jacks on the projector, matching the red and white plugs to the red and white jacks.
4. Connect the plugs at the other end of the A/V cable to the corresponding red and white audio output jacks on your video source.

note

The internal speaker is disabled when you use an external audio system.

Connecting to External Speakers or a PA System

The projector's internal speaker is loud enough for most small- or medium-size rooms. For large rooms or maximum volume, you can connect the projector to external speakers or a public address (PA) system.

You will need an RCA-to-3.5 mm stereo audio cable, which may be included with your sound system, or may be purchased from an electronics store.

Before you start, make sure the projector and speakers or PA system are turned off.

1. Connect the cable's 3.5 mm stereo miniplug to the projector's **Audio Out** jack.

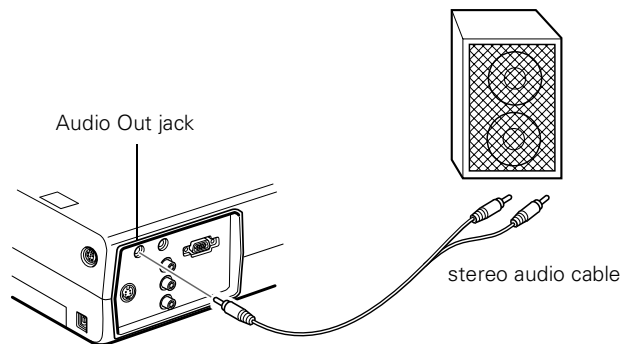

2. Connect the RCA plugs to the speaker or PA system. Insert the cable's red plug into the Audio R jack, and the white plug into the Audio L jack.

note

You can connect a Kensington anti-theft device (available from computer stores) to the port on the side of the projector.

Turning the Projector On and Off

After you have connected your computer and other equipment, you can plug in the projector and turn it on.

1. Connect the power cord to your projector's power inlet.

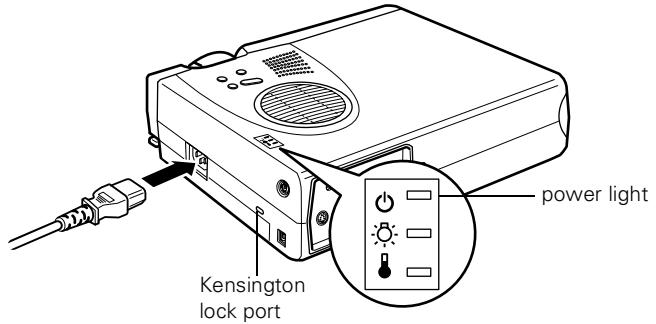

2. Plug the other end of the cord into a grounded electrical outlet.

The power light on top of the projector turns orange. This indicates that the projector is receiving power, but is not yet turned on.

3. Use the tab on the lens ring to rotate the ring and pop out the lens.

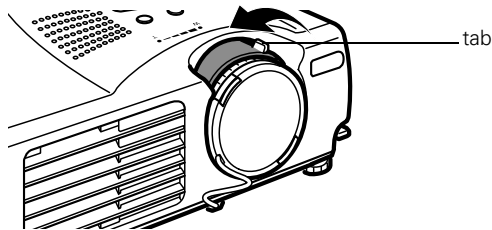

4. Squeeze the lens cap tabs and remove the lens cap.

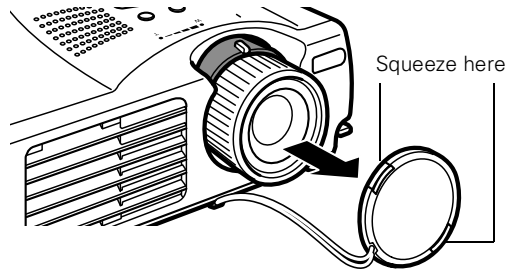

warning

Never look into the lens when the lamp is on. This can damage your eyes, and is especially dangerous for children.

5. Press the red Power button on top of the projector.

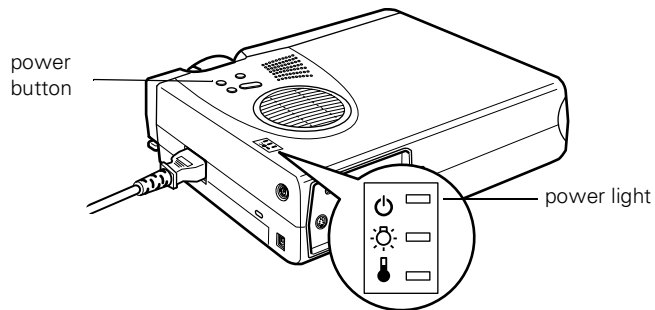

The power light flashes green, and then stays on. You may see a blue screen with the message **No Signal** displayed. This is normal.

6. Turn on or restart your computer. In a few moments, you should see the computer display projected.

You may need to press a function key on your laptop to switch between the LCD screen and the projector, or to display on both at the same time. Check your laptop's manual or online help for instructions.

On a PowerBook, you'll need to choose **Mirroring** in the Display Control Panel of your PowerBook if you want to display on the LCD screen as well as the projector screen.

When you are ready to turn off the projector, follow these steps:

1. Press the red **Power** button on top of the projector. You see a confirmation message. (If you don't want to turn it off, press any other button.)
2. Press the **Power** button again. The power light flashes orange for about a minute and the fan gets louder as the projector cools down. When the projector has cooled, the orange light stays on and the fan shuts off.

If you want to turn the projector on again, wait until the orange light stops flashing. Then press the **Power** button.

3. When you are finished using the projector, replace the lens cap, retract the lens, and unplug the power cord.

caution

To avoid damaging the lamp, never unplug the power cord when the power light is green.

Turning On Other Equipment

If you're using a VCR, other external video source, or additional equipment with the projector, turn on the equipment in this order:

1. Video source
2. External audio source
3. Projector
4. External speakers or PA system
5. Computer

When you're ready to shut down, turn off the equipment in the reverse order.

2 *Projecting a Presentation*

Once you have your PowerLite connected (as described in Chapter 1), you're ready to adjust the image and give your presentation. This chapter covers the following:

- Displaying your image
- Adjusting your image
- Using the remote control
- Zooming your image with the remote
- Resizing your image
- Turning off the picture
- Working with audio and video
- Drawing on the screen
- What to do when the projector lights flash
- Using the on-screen help
- Shutting down the projector

Displaying Your Image

Make sure your projector and other equipment are set up and connected correctly, following these guidelines:

- Place the projector on a sturdy, level surface, between 3.5 and 45 feet from the screen.
- Make sure the projector is within 10 feet of a grounded electrical outlet or extension cord.
- Place the computer and/or video source within 5 feet of the projector.
- Make sure the projector is perpendicular to the screen. Otherwise, your image will be distorted.

For more information about locating and positioning the projector, see Chapter 1.

Follow these steps to display your image:

1. If you're using a VCR or other video source, turn it on before you turn on the projector.
2. To turn on the projector, press the red **Power** button on top of the projector.

The power light flashes green, and then stays on. You may see a blue screen with the message **No Signal** displayed. This is normal.

warning

Never look into the lens when the lamp is on. This can damage your eyes, and is especially dangerous for children.

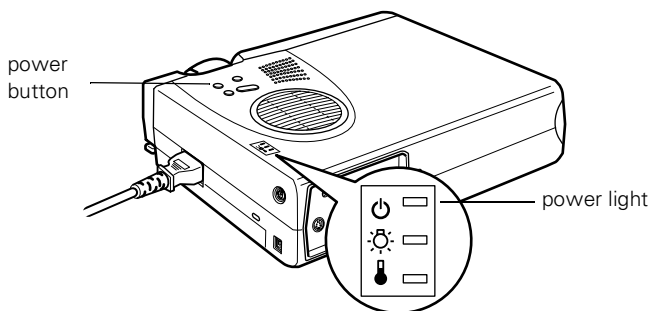

note

The lamp shuts off (and the Power light turns orange) automatically if the projector hasn't received a video signal for 30 minutes. This saves electricity and extends the life of the lamp. Press the Power button to turn on the lamp again.

3. Turn on or restart your computer. In a few moments, you should see the computer display projected.

You may need to press a function key on your laptop to switch between the LCD screen and the projector, or to display on both at the same time. Check your laptop's manual or online help for instructions.

On a PowerBook, you'll need to choose **Mirroring** in the Display Control Panel of your PowerBook if you want to display on the LCD screen as well as the projector screen.

4. If you're using both a computer and a video source, you may need to press the **Source** button on top of the projector.

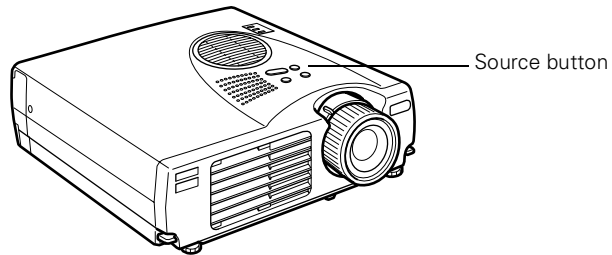

This switches the display between the video source and the computer.

5. Press the **Source** button to switch again if necessary.

Adjusting Your Image

Once the image you want is displayed, you may need to adjust the size, focus, position, and image shape.

Focusing and Zooming Your Image

Rotate the focus ring to sharpen the image.

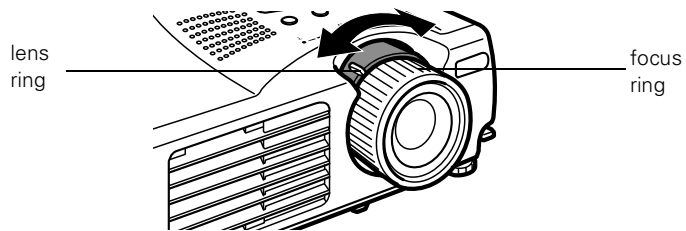

Rotate the lens ring (from *W* to *T*) to zoom out.

- If the image is not large enough, you may need to move the projector farther away from the screen. You can also use the **E-Zoom** button on the remote control to zoom in on a portion of the image. See page 33 for instructions.
- If only part of the computer image is displayed, open the lower cover on the remote control and press the **Resize** button. See page 33 for more information.
- If the image is distorted, crooked, or has a keystone shape, press the **Keystone** button on top of the projector to correct it. See page 30 for instructions.
- If the image is too low, you can reposition it. See the next section for instructions.

Positioning Your Image

Make sure your image is high enough for everyone in your audience to see. If the image is too low, you can extend the projector's feet to raise the lens.

caution

To avoid damaging the lens, do not hold the projector by the lens.

1. Stand behind the projector and hold it while you press the blue foot release levers. This unlocks the feet.

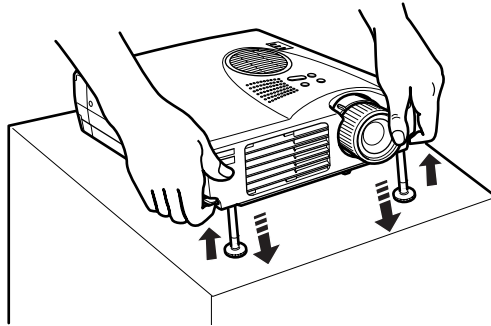

2. While pressing the foot release levers, raise or lower the projector until the image is positioned where you want it.
3. Release the levers to lock the feet in the new position.
4. To fine-tune the height of the projector, turn the feet. Turn clockwise to raise the projector and counterclockwise to lower it.

Adjusting the Image Shape

The projected image may have a distorted or “keystone” shape. This can be caused by raising the front of the projector to position the image for your audience. You can adjust the image shape by pressing the **Keystone** button on top of the projector.

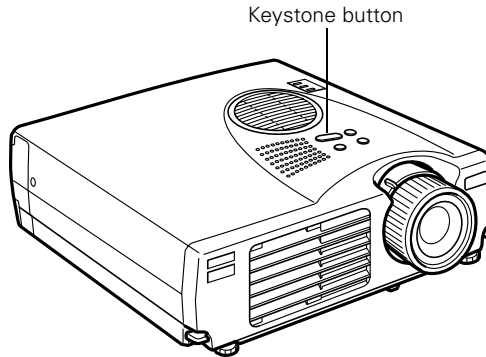
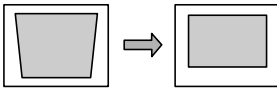

1. Press on the right + or left – side of the **Keystone** button to adjust the image shape.
2. Press and hold either side of the **Keystone** button until the image is rectangular.

Using the Remote Control

The remote control lets you access all of your projector’s features from anywhere in the room (up to 30 feet away). You can use it to turn the projector on and off, zoom the image, and display the projector’s setup menu, for example.

If you have connected the mouse cable (as described on page 14 and page 17), you can also use the remote control as a wireless mouse to run your presentation.

Operating the Projector with the Remote Control

Before you can use the remote control, you need to install the batteries, as described on page 9.

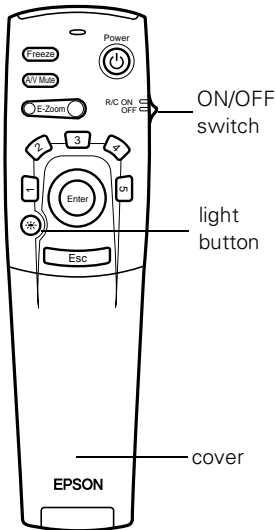

1. Push up the switch on the side of the remote control to turn it on.
2. Press the round light ☀ button. The other buttons on the remote light up temporarily. If they don't light up, you need to change the batteries. See page 9 for instructions.
3. Point the remote at the projector or at the screen.
4. Press the button for the function you want to use. See pages 33 to 39 for more information.

For some functions, you need to use the Enter button to navigate on the screen. Press on the edge of the button with your thumb. Or, grasp it between your thumb and finger and tilt it in the direction you want to move.

5. To access additional buttons, pull down the cover below the Esc button.

The additional buttons on the lower part of the remote are shown at the left. See pages 33 to 36 for instructions on using these buttons to control the projector.

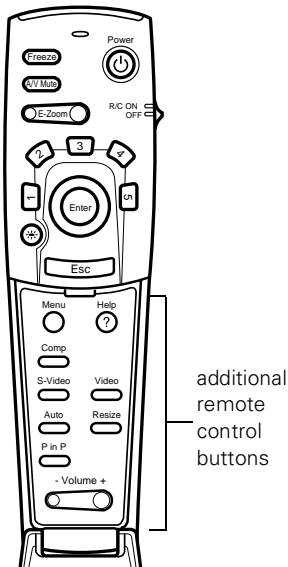

note

When you connect the mouse cable, you can't use an external mouse with your laptop. However, you may still be able to use the built-in mouse pointer.

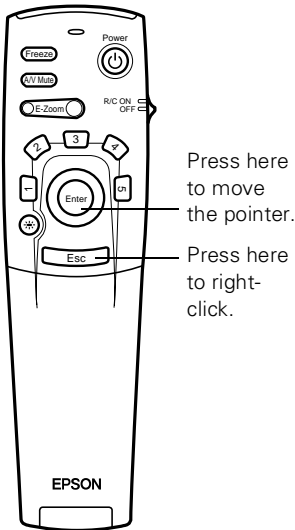

Using the Remote Control as a Wireless Mouse

Using the remote control as a wireless mouse gives you more flexibility in delivering your presentation. You can stand anywhere in the room and interact with your audience. You don't need to stay near your computer or the projector.

You must first connect the mouse cable between the projector and your computer. See page 14 (PC laptop) or page 17 (PowerBook) for instructions.

- Point the remote at the screen and press on the edge of the **Enter** button with your thumb. Or, grasp it between your thumb and finger. This button works like a trackball to move the mouse pointer on the screen.
- To click, press down on the center of the **Enter** button. This is the equivalent of a left mouse click.
- To right-click, press the **Esc** button.
- To double-click, press down twice on the **Enter** button.
- To click and drag, press down on the **Enter** button and then tilt it in the direction you want to drag.
- To change slides in a PowerPoint® presentation (in Slide Show mode), press down on the **Enter** button.

With a little practice, you'll be able to give a presentation and work with your computer using the remote control.

Zooming Your Image with the Remote

The lens ring lets you reduce your image if it's too large. You can zoom in on a portion of the image using the **E-Zoom** button on the remote control.

1. Press the right side of the **E-Zoom** button to zoom in on your image.
 - Press the button repeatedly to enlarge it up to 4 times in 25% steps.
 - Press and hold the button to zoom in to the size you want.
2. Use the **Enter** button to pan around the screen if necessary.
3. Press the left side of the **E-Zoom** button to zoom out. You can press the button repeatedly, or press and hold to zoom all the way out.

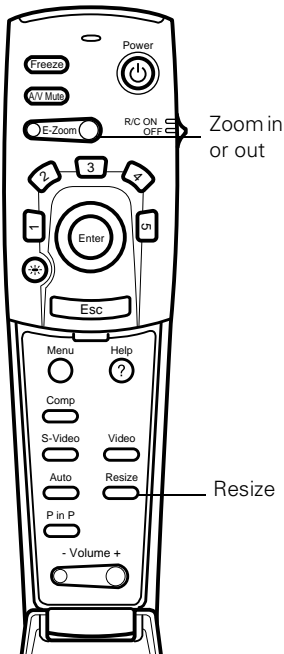

note

*When you're projecting from a VCR or other video source, you can use the **Resize** button to switch from a 4:3 aspect ratio to 16:9.*

Resizing Your Image

If only part of your computer screen is displayed, your computer may be set for a higher resolution than the projector's "native" display—1024 × 768 pixels (PowerLite 700c/710c) or 800 × 600 pixels (PowerLite 500c). You can resize the image to fit the resolution of your projector.

- Press the **Resize** button on the lower part of the remote control. The screen image is automatically compressed.
- Continue pressing the **Resize** button to pan around the screen in the original resolution.

If you have zoomed in on your image, you can also use the **Resize** button to switch it back to the original display size.

Turning Off the Picture

You can use the **A/V Mute** button on the remote control to turn off the image (and sound) and darken your screen. This is useful if you want to temporarily re-direct your audience's attention without the distraction of a bright screen.

- To turn off the picture, press the **A/V Mute** button. The screen goes dark.
- To turn the image back on, press the button again.

Working with Audio and Video

If your presentation includes video and/or audio, you can use the remote control to select your source, freeze the action, adjust the sound, or display picture in picture. Make sure you have set up your projector and connected your audio or video source as described in Chapter 1.

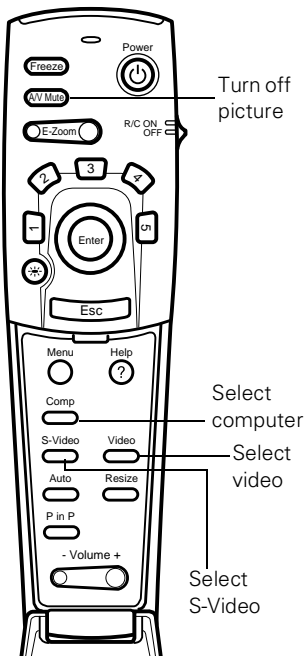

Selecting Your Video Source

You can use the **Source** button on top of the projector to toggle between your computer and VCR or other video source. However, you may find it more convenient to select your source with the remote control.

You can connect two video sources to the projector if one supports S-video and you have an S-video cable (not included). Then you can use the buttons on the remote control to switch between a standard video source, an S-video source, and your computer.

- Press the **Video** button to select a standard video source.
- Press the **S-Video** button to select an S-video video source.
- Press the **Comp** button to select your computer display.

After you select a source, the screen goes dark for a moment before the image appears.

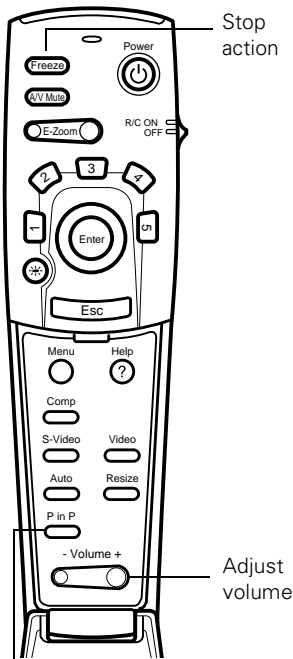

Display picture in picture

Stopping Action

You can use the remote control to stop the action in your video or computer.

- Press the **Freeze** button to stop the action and keep the current image on the screen. The sound will continue.
- Press the **Freeze** button again to re-start it.

Adjusting Sound Volume

Using the remote control, you can adjust the volume of your video or computer sounds.

- To increase the volume, press on the right (+) side of the **Volume** button.
- To reduce the volume, press on the left (-) side of the **Volume** button.

Displaying Picture in Picture Video

You can open a small video window on your computer image, and view a video at the same time as your computer presentation. Make sure you have connected your VCR or other video source as described in Chapter 1.

1. Press the **P in P** button on the remote control. The screen goes dark for a moment, and then your video image appears in a small window on the screen. A menu appears in the lower left corner of the screen.
2. Press the side of the **Enter** button (or grasp it between your thumb and finger) to move the video window on the screen. You can use the **E-Zoom** button to enlarge or reduce the video window.

- When the window is located and sized the way you want, press down on the **Enter** button. The menu disappears, and your video plays on the screen.

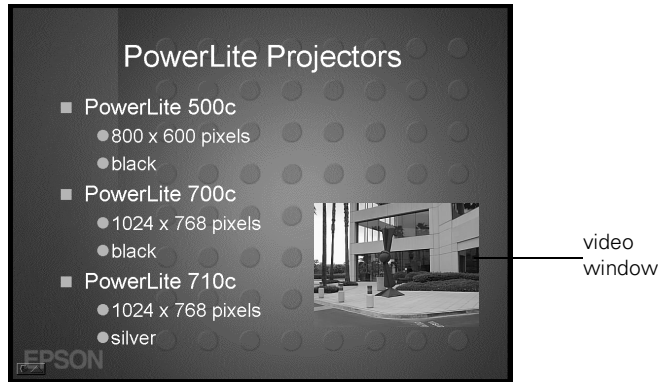

- When you're finished viewing the picture-in-picture, press the **P in P** button again. The video window disappears.

Drawing on the Screen

The projector's drawing controls or "special effects" let you highlight areas on the screen using the numbered buttons on the remote control. You can use these features to annotate your presentation slides or call attention to your most important points. Four types of drawing tools are available:

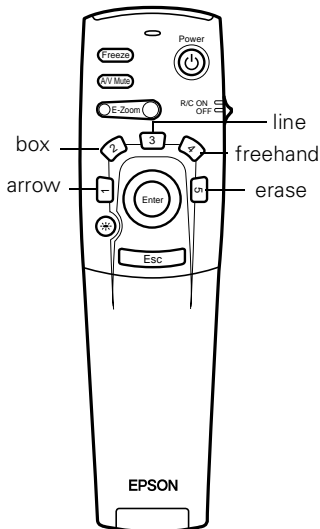

- Arrow or cursor stamp (button 1)
- Box (button 2)
- Horizontal or vertical line or marker (button 3)
- Freehand line (button 4)
- Erase (button 5)

You can use the Effects menu to customize all the drawing tools. See page 51 for instructions.

Using the Cursor/Stamp Arrow

You can use the cursor stamp tool as a pointer and place bright yellow arrows anywhere on your screen.

note

If you don't like the yellow arrow, you can use the projector's menu system to change it to a different type of arrow, pointing hand, ball, or cross. See page 52 for instructions on customizing the cursor stamp tool.

1. To activate the cursor stamp arrow, press the **1** button on the remote control. A yellow arrow appears in the upper left corner of the screen. 
2. Press the side of the **Enter** button (or grasp it between your thumb and finger) to move the arrow wherever you want it.
3. To “paste” the arrow on the screen, press down in the center of the **Enter** button. You can then continue to work with another arrow, moving it around the screen or pasting it wherever you want.
4. To erase the arrows pasted on the screen, press the **5** button.
5. To cancel the cursor stamp feature, press **Esc**.

Drawing Boxes

You can draw transparent green boxes on the screen to highlight areas of your presentation or video.

1. To activate the box tool, press the **2** button on the remote control. A small green square appears in the upper left corner of the screen. This is the “box-drawing” tool. 
2. Press the side of the **Enter** button (or grasp it between your thumb and finger) to move the square where you want to begin drawing the box.
3. To define the upper left corner of the box, press down in the center of the **Enter** button. You see a corner mark on the screen.
4. Press the side of the **Enter** button (or grasp it between your thumb and finger) and drag the square down and to the right to define the lower right corner of the box.
5. Press down in the center of the **Enter** button. You see a transparent box on the screen, as shown at the left.



note

If you don't like the green color, you can use the projector's menu system to change it. You can also change the box shape to have rounded corners. See page 53 for instructions on customizing the box tool.

You can continue placing boxes on the screen by repeating steps 2 through 5.

6. To erase the box(es), press the **5** button.
7. To cancel the box drawing feature, press **Esc**.

Drawing Horizontal and Vertical Lines

You can draw bright pink horizontal or vertical lines on the screen to underline or highlight your presentation points.

1. To activate the line or marker tool, press the **3** button on the remote control. A pink marker icon appears in the upper left corner of the screen. This is the “line-drawing” tool. 
2. Press the side of the **Enter** button (or grasp it between your thumb and finger) to move the marker where you want to begin drawing the line.
3. To define the beginning of the line, press down in the center of the **Enter** button. You see a corner mark on the screen.
4. Press the side of the **Enter** button (or grasp it between your thumb and finger) and drag the marker where you want the line to end.
5. Press down in the center of the **Enter** button. You see a pink line on the screen, as shown at the left. (The line may be a different color if you draw on a dark area of the screen.)



You can continue placing lines on the screen by repeating steps 2 through 5.

6. To erase the line(s), press the **5** button.
7. To cancel the line drawing feature, press **Esc**.

note

You can change the width and color for both “marker” and freehand lines, using the projector’s menu system. See page 53 for instructions on customizing the marker and freehand tools.



Drawing Freehand Lines

The freehand drawing tool lets you click and drag to draw opaque marks anywhere on the screen.

1. To activate the freehand tool, press the **4** button on the remote control. A pointing hand appears in the upper left corner of the screen. 
2. Press the side of the **Enter** button (or grasp it between your thumb and finger) to move the hand where you want to begin drawing.
3. Press down in the center of the **Enter** button and press on one of the edges or move it around to draw.
4. To end a line or shape after drawing it, press down in the center of the **Enter** button.







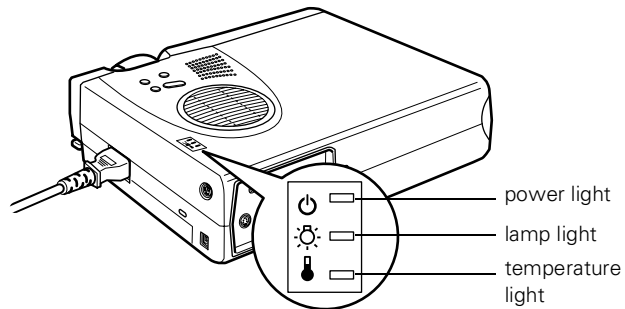



You can continue drawing on the screen by repeating steps 2 through 4.

5. To erase your drawing(s), press the **5** button.
6. To cancel the freehand drawing feature, press **Esc**.

What To Do When the Lights Flash



The lights on top of the projector indicate the projector's status and let you know when a problem occurs.

Light	Status	Description and action
	orange	The projector is in sleep mode. You can unplug it or press the Power button to turn it on.
	flashing green	The projector is warming up. Wait for the image to appear.
	green	The projector is operating normally.
	flashing orange	The projector is cooling down. You can't turn the projector on or unplug it when the light is flashing.
	red	Power is cut off because of an internal problem. Contact EPSON for help.
	red	The lamp is almost burned out. This is a good time to replace it. See Chapter 4 for instructions.
	flashing orange	The lamp is burned out. Replace the lamp, following the instructions in Chapter 4.
	flashing red	There is a problem with the lamp, power supply, fuse, or circuit. Contact EPSON for help.
	flashing orange	The projector is too hot. Turn it off and let it cool before using it.
	red	The projector has turned off automatically because it has overheated. Let it cool for a few minutes, then turn it back on. Make sure nothing is blocking the vents on the front and top of the projector. If it continues to overheat, you may need to change the air filter. See Chapter 4 for instructions.
	flashing red	There is a problem with the cooling fan or temperature sensor. Contact EPSON for help.

note

You can also use the Help and Enter buttons on the remote control to access and navigate the help system.

Using the On-Screen Help

If you have a problem while setting up or using your PowerLite, you can get help by pressing the blue **? Help** button on top of the projector. The following choices are available:

- **Help for the image**
Tells you how to solve problems with a blank screen, blurry images, brightness, colors, and image shape
- **Help for the sound**
Provides help for problems with lack of audio
- **Language Selection**
Lets you choose to display the help information and projector menus in any of 8 different languages, including Chinese, Japanese, and Korean
- **Return**
Exits the help system.

Follow these steps to get help for image problems.

1. Press the blue **? Help** button on top of the projector. You see the main HELP Menu.
2. Press the left side of the **Select (Keystone)** button to highlight **Help for the image**.
3. Press the **Enter (Source)** button to select **Help for the image**. You see the following choices:
 - An image does not appear on the Screen.
 - The image is blurred.
 - The image is not displayed fully on the screen. (cut off/too big/too small/partial).
 - The colors of the image are not correct.
 - The image is too dark.
 - The image is a trapezoid.
 - Return.

note

Wherever you see Return listed on the screen, you can select it and press the Enter (Source) button to return to the previous menu.

4. Press the left side of the **Select (Keystone)** button to highlight the problem you want to solve. Then press the **Enter (Source)** button to select the solution(s).

Depending on your choice, you may see another menu, or you may see a list of solutions.

5. Press the left side of the **Select (Keystone)** button to highlight a solution (if this choice is available). Then press the **Enter (Source)** button to select the solution.

To exit the Help system, press the blue **? Help** button on top of the projector.

Shutting Down the Projector

When you're finished using the projector, you should follow the recommended procedure to shut it down. This extends the life of the lamp and ensures efficient operation. Turn your computer off first, before you turn off the projector.

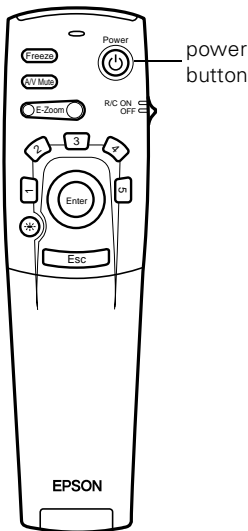

1. To turn off the projector, press the red **Power** button on the projector or remote control. You see a confirmation message. (If you don't want to turn it off, press any other button.)

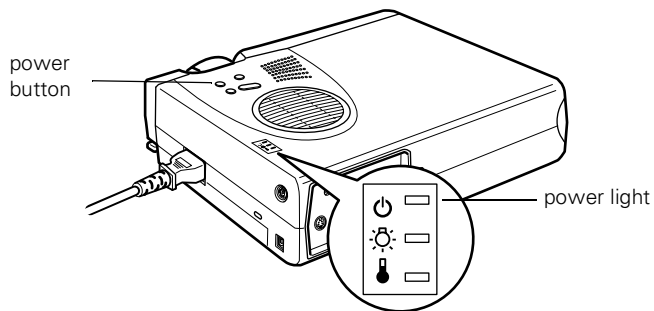

2. Press the **Power** button again. The power light flashes orange for about a minute and the fan gets louder as the projector cools down. When the projector has cooled, the orange light stays on and the fan shuts off.

caution

To avoid damaging the lamp, never unplug the power cord when the power light is green.

If you want to turn the projector on again, wait until the orange light stops flashing. Then press the **Power** button.

3. Replace the lens cap, retract the lens, and unplug the power cord.
4. Turn off the remote control.
5. If you're using a VCR or other external audio or video source, turn it off after you turn off the projector.
6. Disconnect all equipment.
7. Store the projector in the bag that came with it or in a protective case.

3 *Fine-Tuning Your Projector*

You can use the on-screen menus to adjust the image, sound, and other features of your projector. You can also create your own startup screen, customize the “drawing” controls, and view information about the current display settings and lamp status. This chapter covers the following information:

- Using the menu system
- Adjusting the image
- Adjusting the sound
- Customizing the drawing controls
- Customizing projector features
- Creating your own startup screen
- Viewing information

Using the Menus

The on-screen menus let you customize and adjust projector features. The following 8 menus and features are available:

- **Video**
Controls the look and quality of the projected image (from a computer or video source).
- **Audio**
Adjusts the volume and tone (treble/bass).
- **Effect**
Customizes the drawing tools available on the remote control.
- **Setting**
Adjusts features such as the keystone setting, blank screen color, message prompt, and power management system.
- **User's Logo**
Lets you capture and store an image to be displayed with the **A/V Mute** button, or as the startup screen.
- **Advanced**
Controls settings such as menu language, use of startup screen, color temperature, and rear or ceiling projection. See the *User's Guide Supplement* on the projector CD-ROM for information about these settings.
- **About**
Provides information about lamp usage and the current display settings.
- **Reset All**
Restores the factory defaults for all the projector settings.

For complete information about all of the menu settings, see the *User's Guide Supplement* on the CD-ROM that came with your projector.

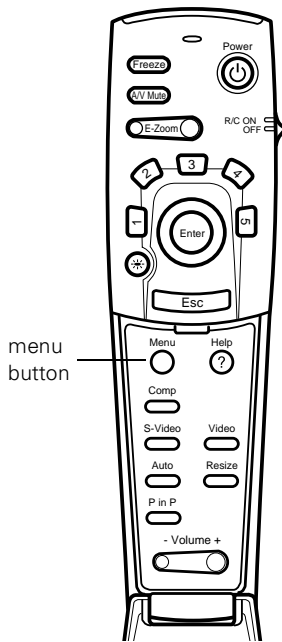

Changing Menu Settings

You use the **Menu**, **Enter** and **Esc** buttons on the remote control to change menu settings.

1. To access the menu system, open the cover on the lower part of the remote control and press the **Menu** button. You see the following:



The 8 menus are displayed at the left, and the options available for the video menu are shown on the right.

2. Press the bottom of the **Enter** button (or grasp it between your thumb and finger and tilt it down) to scroll through the menus.

When you highlight a menu, its options are shown on the right.

3. When the menu you want is highlighted, press the center of the **Enter** button to select it.

The highlight moves to the first option for that menu.

4. Press the bottom of the **Enter** button (or grasp it between your thumb and finger and tilt it down) to scroll through the options.
5. Press the right or left side of the **Enter** button (or grasp it between your thumb and finger and tilt it to the side) to change the setting.

6. If you want to go back to the default settings on any menu, select **Reset**, press **Enter**, select **Yes**, and then press **Enter**.
7. Press the **Esc** button on the remote to go back to the main menu display. Your changes are saved automatically.
8. Press the **Menu** button to exit the menu system.

note

Slightly different settings are available on the Video menu when you're projecting from a video source, rather than from your computer. You can also adjust video settings from the projector's help system.

Adjusting the Image

You can adjust a number of image features with the Video menu, including:

- Image positioning
- Brightness
- Contrast
- Color Balance
- Sharpness
- Gamma

Additional settings are available on the Video menu for tracking, sync, and auto setup. Normally you won't need to change these settings unless you have a problem with your projector. See the *User's Guide Supplement* for more information.

Repositioning the Image

Follow these steps to fine-tune the image position:

1. Press the **Menu** button. You see the main menu listing, with the Video menu highlighted (as shown on page 47).
2. Press **Enter** to select the Video menu.

note

If you have repositioned the image or adjusted the sync setting, you can use the Auto button on the remote control to restore the default settings.

3. Press **Enter** to select the Position option. You see the following on the right side of the screen:
4. Tilt the **Enter** button in the direction you want to move the image: left, right, up, or down.

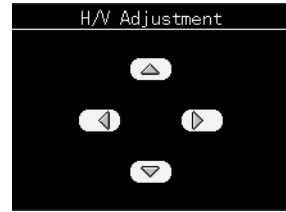

5. When the image is positioned the way you want, press **Esc**.

Adjusting Image Appearance

Follow these steps to adjust the brightness, contrast, sharpness, or gamma:

1. Press the **Menu** button. You see the main menu listing, with the Video menu highlighted.
2. Press **Enter** to select the Video menu.
3. Press the bottom edge of the **Enter** button (or tilt it down) repeatedly to select one of the following options:
 - Brightness
 - Contrast
 - Sharpness
 - Gamma (a measurement affecting overall brightness, contrast, and color balance)
4. Press the right side of the **Enter** button to increase the setting or the left side to decrease it. You see the effect of your changes on the screen.
5. When the image is set the way you want it, press **Esc**.

Adjusting Image Color

Follow these steps to adjust the color:

1. Press the **Menu** button. You see the main menu listing, with the Video menu highlighted.
2. Press **Enter** to select the Video menu.

3. Press the bottom edge of the **Enter** button (or tilt it down) repeatedly until **Color** is highlighted.
4. Press **Enter** to select **Color Adjustment**. You see the following:

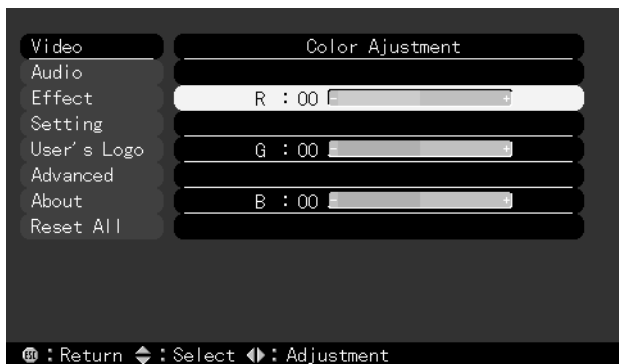

5. Press the right side of the **Enter** button to increase the amount of **R** (red) in the image or the left side to decrease it. You see the effect of your changes on the screen.
6. Press the bottom edge of the **Enter** button (or tilt it down) to select the **G** (green) or **B** (blue) setting.
7. Press the right side of the **Enter** button to increase the color setting or the left side to decrease it.
8. When the image is set the way you want, press **Esc**.

Adjusting the Sound

You can use the Audio menu to adjust the sound volume or tone (treble/bass balance).

1. Press the **Menu** button. You see the main menu listing, with the **Video** menu highlighted.
2. Press the bottom edge of the **Enter** button (or tilt it down) to highlight **Audio**.

You see the following:



3. Press **Enter** to select the Audio menu.
4. Press the right side of the **Enter** button to increase the volume or the left side to decrease it. This works the same as the **Volume** button on the remote control.
5. To select the Tone setting, press the bottom edge of the **Enter** button (or tilt it down).
6. Press the right side of the **Enter** button to increase the treble or the left side to increase the bass.

When you're finished adjusting the sound, press **Esc** or **Menu**.

Customizing the Drawing Tools

The drawing tools let you highlight your presentation with lines, boxes, and other types of annotations, as described on pages 36 to 39. You can use the Effect menu to customize these tools. In addition to individual tool settings, you can also set the cursor speed for drawing. The **Reset** option on the Effects menu lets you return all the drawing tools to their default settings.

Customizing the Cursor/Stamp

You can change the cursor/stamp from a yellow arrow to a different type of arrow, a ball, a pointing hand, or a cross.

1. Press the **Menu** button. You see the main menu listing, with the Video menu highlighted.
2. Press the bottom edge of the **Enter** button (or tilt it down) to highlight **Effect**. You see the Effect menu:



3. Press **Enter** to select the Effect menu. The Cursor/Stamp Setting is highlighted.
4. Press **Enter** to select Cursor/Stamp Setting. You see several choices for the cursor stamp:

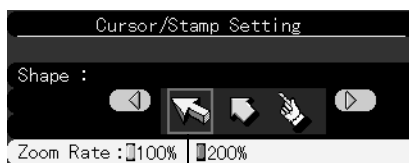

Selected icon appears here.

5. Press the right or left edge of the **Enter** button to scroll through all the choices, which include arrows, balls, a pointing hand, and a cross.

Scroll through the icons until the one you want to use appears in the pink box.

6. If you want to enlarge the cursor/stamp icon, press the bottom edge of the **Enter** button (or tilt it down) to highlight Zoom Rate. Then press the right side of the **Enter** button to select 200%.
7. When you're finished customizing the cursor/stamp tool, press **Esc**.

Customizing the Box, Line and Marker Tools

You can change the color and line width for the line drawing tools, and also change the shape of the box tool.

1. Press the **Menu** button. You see the main menu listing, with the Video menu highlighted.
2. Press the bottom edge of the **Enter** button (or tilt it down) to highlight **Effect**.
3. Press **Enter** to select the Effect menu. The Cursor/Stamp Setting is highlighted.
4. Press the bottom edge of the **Enter** button (or move it down) to highlight the tool you want to customize.
5. Press **Enter** to select the tool. You see a choice of 8 colors:



6. Press the right or left edge of the **Enter** button to scroll through the colors until the one you want is selected (the button next to it will be green instead of gray).
7. If you want to change the box shape or line width, press the bottom edge of the **Enter** button (or tilt it down) to highlight the Shape or Width setting.

8. Press the right or left edge of the **Enter** button to choose the box shape (round or square corners), or the line width (from 2 to 32 pixels for the marker and 2 to 148 pixels for the freehand line).
9. When you're finished customizing the drawing tool, press **Esc**.

You can select another drawing tool to customize or press **Esc** again to return to the main menu.

Customizing Projector Features

You can use the Setting menu to turn on the projector's power management system, adjust the image shape, and customize several other features.

1. Press the **Menu** button. You see the main menu listing, with the Video menu highlighted.
2. Press the bottom edge of the **Enter** button (or tilt it down) repeatedly to highlight **Setting**. You see the features and their settings on the right side:

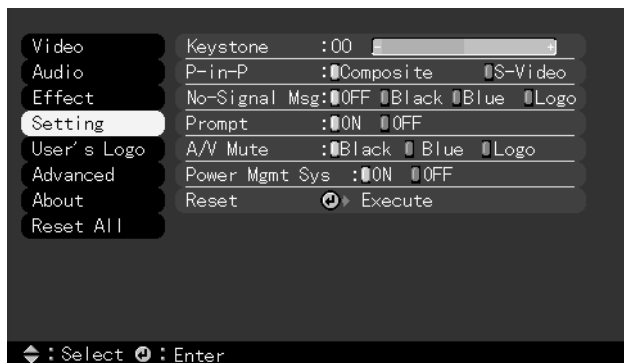

3. Press **Enter** to select the Setting menu. The Keystone setting is selected.

You can use the **Enter** button to adjust this setting, which works the same as the Keystone button on top of the projector.

4. Press the bottom edge of the **Enter** button (or tilt it down) repeatedly to select one of the following options:
 - **P-in-P**
Changes from a composite (standard) video source to an S-video source for the picture-in-picture display.
 - **No-Signal Msg**
Selects the screen color and message to display when the projector is not receiving a signal. The logo setting displays an image that you have transferred to the projector. See page 56 for instructions on transferring an image to use as the no-signal message.
 - **Prompt**
Turns off the identifying text that appears briefly when you switch from computer input to a video source.
 - **A/V Mute**
Selects the screen color or image to display when you press the **AV/Mute** button. The logo setting displays an image that you have transferred to the projector. See page 56 for instructions on transferring an image to use for the A/V Mute display.
 - **Power Mgmt Sys**
Turns on the power management system, which takes effect when your laptop goes into sleep mode.
5. Press the right side of the **Enter** button to move through the settings available for each option.
6. When you're finished, press **Esc**.

Creating Your Own Startup Screen

You can transfer any image on your computer to the projector, and then use it as the screen displayed when the projector is not receiving a signal. You can also set it to be displayed when you press the **A/V Mute** button on the remote, or as a startup screen. The image can be a company logo, slogan, photograph, or any other image you want to use.

Capturing the Image

You start by displaying the image you want to use on the projector. You can use an image from either a computer or video source such as a VCR or digital camera. Then follow these steps to capture the image and transfer it to the projector:



1. Press the **Menu** button. You see the main menu listing, with the **Video** menu highlighted.
2. Press the bottom edge of the **Enter** button (or tilt it down) to highlight the **User's Logo** menu.
3. Press **Enter** to select this feature. You see the message shown at the left.
4. Select **Yes** and press **Enter**. A selection box displays over the image.
5. Use the **Enter** button on the remote control to select the area of the image you want to use. Once you have selected the entire area, press **Enter**.
6. When you see the message "Do you use this image?" select **Yes** and press **Enter**. If you want to change the area selected, select **No** and repeat step 5. You see the message shown at the left.
7. Use the **Enter** button on the remote control to select a zoom rate (display size), and then press **Enter**.
8. When the message "Do you save this user logo?" appears, select **Yes** and press **Enter**.

Saving the logo may take a few moments. Do not use the projector or other sources (computer, video, speaker, etc.) while the logo is being saved.

9. When you see the message “Saving the user logo is completed,” press the **Menu** or **Enter** button to redisplay the main menu.

note

You can also set up your image as a startup screen. Use the Advanced menu to enable the startup screen.

Assigning the Image to the No-Signal Message and/or A/V Mute Button

After your image is saved, you can set it up as the no-signal message and/or the screen that’s displayed when you press the **A/V Mute** button.

1. Press the **Menu** button. You see the main menu listing, with the **Video** menu highlighted.
2. Press the bottom edge of the **Enter** button (or tilt it down) to highlight the **Setting** menu.
3. Press the **Enter** button to select the **Setting** menu.
4. Press the bottom edge of the **Enter** button (or tilt it down) to highlight **No-Signal Msg**.
5. Press the right side of the **Enter** button to select **Logo**. This sets your image as the screen displayed when the projector is not receiving a signal.
6. If you want to set up your image as the **A/V mute** display, press the bottom edge of the **Enter** button (or tilt it down) to highlight **A/V Mute**.
7. Press the right side of the **Enter** button to select **Logo**. This sets your image as the screen displayed when you press the **AV/Mute** button.
8. When you’re finished, press **Esc** or **Menu**.

To test your setting, press the **A/V Mute** button to display your image. Press it again to turn off the image.

Viewing Information

You can use the About menu to view information about the display settings of your computer and the number of hours the lamp has been used.

note

If you access the About menu when the projector display is set to video, you only see the lamp life and the video signal setting.

1. Press the **Menu** button. You see the main menu listing, with the Video menu highlighted.
2. Press the bottom edge of the **Enter** button (or tilt it down) repeatedly to select **About**.

You see the lamp usage hours and computer display settings on the right:

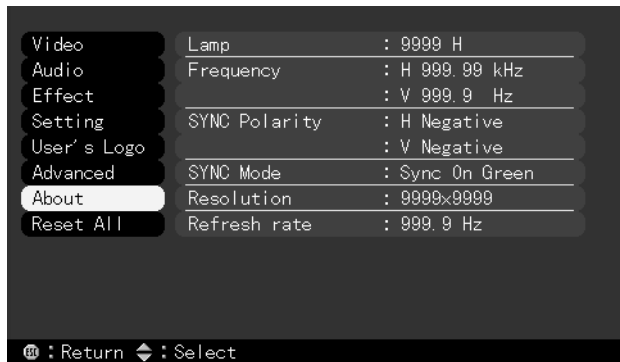

The life span of the lamp is approximately 2000 hours. If the number shown is close to 2000, make sure you have a spare lamp handy.

3. Press **Esc** to exit the menu system, or use the **Enter** button to access another menu.

4

Maintaining and Transporting the Projector

warning

Before cleaning any part of the projector, turn it off and unplug the power cord. Never open any cover on the projector, except the lamp and filter covers. Dangerous electrical voltages in the projector can injure you severely. Do not try to service this product yourself, except as specifically explained in this User's Guide. Refer all other servicing to qualified service personnel.

Your projector needs little maintenance. All you need to do on a regular basis is keep the lens clean. Any dirt or smears on the lens will show up on your projected image.

You also need to clean the air filter on top of the projector periodically. A clogged air filter can block ventilation needed to cool the projector and keep it from overheating.

The only parts you should replace are the lamp and air filter. If any other part needs replacing, contact your dealer or a qualified service person.

This chapter covers the following:

- Cleaning the lens
- Cleaning the projector
- Cleaning the air filter
- Replacing the lamp
- Transporting the projector

Cleaning the Lens

Clean the lens whenever you notice dirt or dust on the surface.

- Lightly wipe the lens surface with a soft, dry, lint-free cloth.
- To remove dirt or smears, moisten a soft cloth with an alcohol-based cleaner and gently wipe the lens surface.

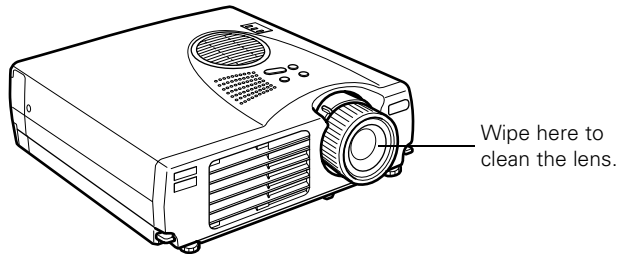

Cleaning the Projector

Before you clean the projector, make sure you turn it off and unplug the power cord.

- To remove dirt or dust, wipe the outside with a soft, dry, lint-free cloth.
- To remove stubborn dirt or stains, moisten a soft cloth with water and a neutral detergent. Then wipe the outside of the projector.
- Do not use alcohol, benzene, thinner, or other chemical detergents. These can cause the projector to warp.

note

When you get a replacement lamp for your projector, a new air filter is included. You should replace the filter when you replace the lamp.

Cleaning the Air Filter

Clean the air filter after every 100 hours of use, or if the  temperature warning light on top of the projector turns red.

If the filter is not cleaned periodically, it can become clogged with dust, preventing proper ventilation. This can cause overheating and damage the projector. Follow these steps to clean the filter:

1. Turn off the projector and unplug the power cord.
2. Pull up on the filter cover tab to release the cover. You may need to use a small screwdriver to pry it off.
3. Remove the cover.

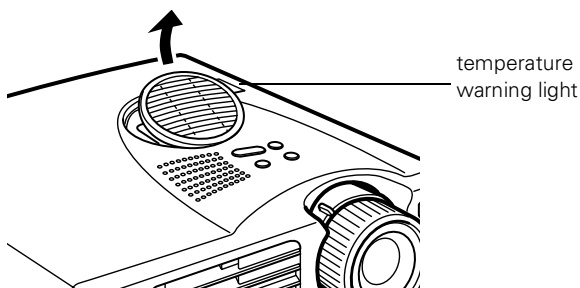

The filter is attached to the inside of the cover.

4. To clean the filter, EPSON recommends using a small vacuum cleaner designed for computers and other office equipment. If you don't have one, use a dry, lint-free cloth.
5. If the dirt is difficult to remove or if the filter is torn, replace it. Contact your dealer to obtain a new filter.
6. Snap the filter cover back into place when you're done.

Replacing the Lamp

The projection lamp typically lasts for about 2000 hours of use. It is time to replace the lamp when you see the following:

- The projected image gets darker or starts to deteriorate.
- The  lamp warning light on top of the projector is either red or flashing orange.
- The message **LAMP REPLACE** appears on the screen when the projector lamp comes on.

This happens after about 2000 hours of use. To maintain projector brightness and image quality, replace the lamp as soon as possible after you see the message.

Contact your dealer or call EPSON Accessories at (800) 873-7766 in the United States and Canada for a replacement lamp. Use the following part number when you order a lamp:

- ELPLP10B (PowerLite 700c/500c)
- ELPLP10S (PowerLite 710c)

warning

Let the lamp cool before replacing it. To avoid premature lamp failure, do not touch the glass portion of the lamp assembly.

Follow these steps to replace the lamp:

1. Turn off the projector and allow it to cool, then unplug the power cord.
2. Before removing the lamp, wait approximately one hour until the projector is fully cooled down.
3. Turn the projector upside-down to access the lamp compartment.

- Using the screwdriver that came with the replacement lamp, loosen the lamp cover screw. You won't be able to remove the screw.
- Remove the cover. You may need to use a small flat-head screwdriver to pry it off.

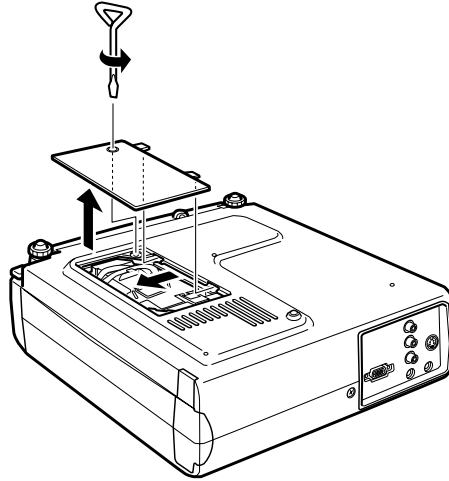

- Remove the two mounting screws on the lamp. Then pull out the lamp using the handle.

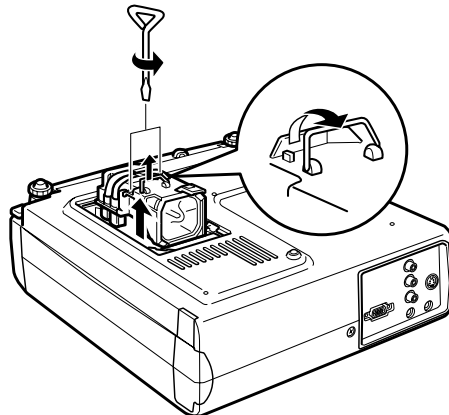

- Gently insert the new lamp unit by lowering it into position. Make sure it is positioned correctly, then press it into place securely.

8. Replace the mounting screws.
9. Snap the cover back into place. Then tighten the screw.

note

EPSON shall not be liable for any damages incurred during transportation.

Transporting the Projector

The projector contains many glass and precision parts. If you need to transport it, please follow these packing guidelines to prevent damage:

- When shipping the projector for repairs, use the original packaging material if possible. If you do not have the original packaging, use equivalent materials, placing plenty of cushioning around the projector.
- When transporting the projector for business use, first put the projector in a carrying case (such as an optional EPSON accessory case), then pack it in a firm box, using cushioning around the case.
- When you are hand-carrying the projector, be sure to store it in a carrying case (such as the optional case available from EPSON).

5 *Solving Problems*

This chapter helps you diagnose and solve problems with your projector, and provides technical support information for problems you can't solve yourself. You can also check the on-screen help by pressing the **Help** button on the control panel or remote control. See page 41 for instructions on using the help system.

This chapter explains the following:

- Projector operation problems
- Image or sound problems
- Where to get help







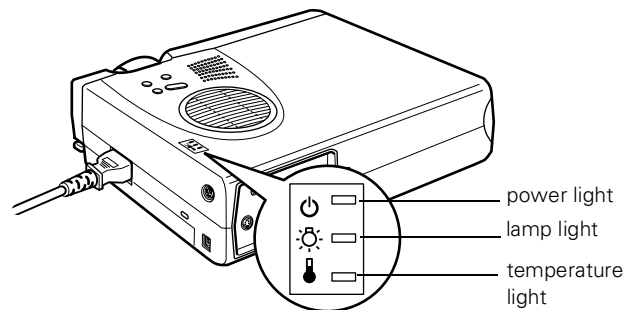



Projector Operation Problems

If your projector isn't working correctly, first turn it off and unplug it. Then plug the power cord back in and turn on the projector.

If this doesn't solve the problem, check the lights on top of the projector. They indicate the projector's status and let you know when a problem occurs, as described on the following page.



Projector Status and Warning Lights

Light	Status	Description and action
	orange	The projector is in sleep mode. You can unplug it or press the Power button to turn it on.
	flashing green	The projector is warming up. Wait for the image to appear.
	green	The projector is operating normally.
	flashing orange	The projector is cooling down. You can't turn the projector on or unplug it when the light is flashing.
	red	Power is cut off because of an internal problem. Contact EPSON for help.
	red	The lamp is almost burned out. This is a good time to replace it. See Chapter 4 for instructions.
	flashing orange	The lamp is burned out. Replace the lamp, following the instructions in Chapter 4.
	flashing red	There is a problem with the lamp, power supply, fuse, or circuit. Contact EPSON for help.
	flashing orange	The projector is too hot. Turn it off and let it cool before using it.
	red	The projector has turned off automatically because it has overheated. Let it cool for a few minutes, then turn it back on. Make sure nothing is blocking the vents on the front and top of the projector. If it continues to overheat, you may need to change the air filter. See Chapter 4 for instructions.
	flashing red	There is a problem with the cooling fan or temperature sensor. Contact EPSON for help.

The power light is flashing orange and you can't turn on the projector.

The lamp is cooling down. Wait until the light stops flashing and then press the **Power** button to turn on the projector.

The power light doesn't come on.

Press the **Power** button to turn off the projector, check that the power cable is connected securely at both ends, then press the **Power** button again to turn the projector on.

warning

Except as specifically explained in this User's Guide, do not attempt to service this product yourself.

Projected images get darker or start to deteriorate, or the  lamp warning light is red or flashing orange.

Replace the lamp as described on page 62.

The  temperature warning light is red.

- The projector is overheating, which turns the lamp off automatically. Let it cool for a few minutes, then press the **Power** button to turn it back on. Make sure nothing is blocking the vents on the top and front of the projector.
- The air filter may be clogged or dirty. Clean it as described on page 61 and then let the projector cool before using it.

If the projector continues to overheat after you clean the air filter, the problem may be caused by damage to the cooling fan or internal circuits. Contact EPSON for help.

The  temperature warning light is flashing orange.

The projector is too hot. Press the **Power** button to turn it off and let it cool for 5 minutes before using it.

Problems with the Remote Control

The projector doesn't respond to remote control commands.

- Make sure the remote control is turned on.
- The remote control batteries may be low on power. Replace them following the instructions on page 9.
- Dim the room lights and turn off any fluorescents. Make sure the projector is not in direct sunlight. Strong lighting, especially fluorescent lights, may affect the projector's infrared receivers.
- Turn off any nearby equipment that emits infrared energy, such as a radiant room heater.
- Make sure you are within 30 feet of the projector.

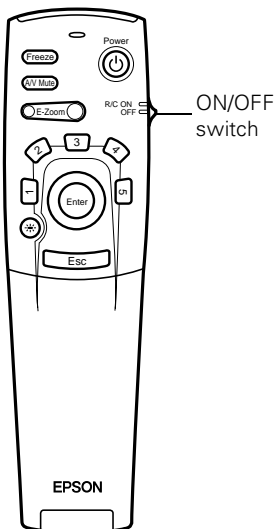

You can't control the mouse pointer with the remote control.

- Make sure the mouse cable is securely connected to both your computer's mouse port and one of the projector's mouse ports. See page 14 (PC laptop) or page 17 (PowerBook) for details.
- Make sure you have used the correct cable. The PS/2 mouse cable and Macintosh mouse cable look the same, but they are not identical. Check the label on the end of the cable.

Image or Sound Problems

No image appears or the message NO SIGNAL is displayed.

- Check that the power light is green and not flashing, the lens is extended, and the lens cover is off.
- Make sure the cables are connected correctly, as described in Chapter 1.
- Make sure the correct image source is selected. Press the **Source** button on top of the projector if necessary.
- Try restarting your computer. You may need to set the display to appear on both the LCD screen and the projector, or to switch between them. Check your laptop's manual or on-screen help for instructions.
- If you're using a Macintosh adapter with a PowerBook or Macintosh, make sure the DIP switches on the adapter are set correctly. (See your Macintosh documentation if you need instructions.)

The image has a distorted, crooked or keystone (trapezoid) shape.

- This may be caused by extending the legs and tilting the projector to position the image. Press the right + or left – side of the **Keystone** button on top of the projector. Press and hold either side of the button until the image is rectangular.
- Make sure the projector is perpendicular to the screen. If the projector is not pointed straight at the screen, your image will be distorted.

Only part of the computer image is displayed.

- If the computer's output resolution setting is higher than 1024×768 (PowerLite 710c/700c) or 800×600 (PowerLite 500c), the image is resized.

If the computer output is not compatible with this resizing, choose a different display setting as follows:

- **Windows:**
In Windows 95/98, right-click on the desktop, select **Properties**, click the **Settings** tab, and use the dialog box to select the resolution you want. In Windows 3.x, use Windows Setup in the Main program group. See your Windows help for more information.
- **PowerBook or Macintosh:**
Choose **Control Panels** under the Apple menu and then choose **Monitors**. In the Monitors screen, choose **Options** and select **Macintosh Hi-Res Display** or another 1024×768 setting (PowerLite 710c/700c) or 800×600 setting (PowerLite 500c). For more information, see your PowerBook documentation. For supported display settings, see the *User's Guide Supplement* on the projector CD-ROM.
- You also may need to modify existing presentation files if you created them for a different resolution. See your software manual for specific information.

The image or parts of it are blurred or out of focus.

- Adjust the Brightness, Contrast, Sharpness, and/or Gamma settings on the Video menu. If you're viewing a computer image, also try adjusting the Tracking and Sync settings. See page 48 for instructions on using the menu.

When you change video settings, you should be able to see the effect on the screen immediately. Feel free to experiment. You can always select **Reset** to return to the factory default settings.

- There may be dirt or smears on the lens. Clean the lens by gently wiping it with an alcohol-based cleaner on a soft cloth. See page 60 for more information.

The image vibrates, flickers, or has vertical lines.

Adjust the Tracking and Sync settings on the Video menu (or through the projector's Help system). It is best to project a gray screen (or the screen you see when you exit Windows) when you adjust these settings. Hold down the button to change the setting until your image looks correct. See page 48 for instructions on using the Video menu.



The image quality is poor on a laptop computer.

The video signal may be split between the computer and the projector. Try turning off the laptop LCD display. See your laptop manual or on-screen help for instructions.

The colors of the image are not right.

- If you're displaying a computer image, use the Color setting in the Video menu to adjust the balance of red, green, and blue.
- If you're displaying video, adjust the Color and Tint (NTSC only) settings on the Video menu.
- Check your computer display settings to correct color balance.

There is no sound.

- Press the right side of the **Volume** button on the remote control to turn up the sound.
- If you're using a VCR or other video source, make sure the volume is not turned all the way down. Also, make sure the cables are connected correctly, as described on page 19.
- If your presentation includes computer audio, make sure the volume control on your laptop is not turned all the way down. Make sure the audio cable is securely connected to both the projector and your computer's  headphone jack or  audio out jack. See page 13 for more information.
- Make sure the Windows volume controls on your computer are not turned all the way down or set to Mute. You may be able to check this by right-clicking the sound icon on your Windows desktop.
- Press the **A/V Mute** button on the remote control to make sure this feature is not enabled.
- Make sure the right source is selected. Press the **Source** button on top of the projector to select the right source.

Where To Get Help

EPSON provides technical assistance through electronic support services and automated telephone services 24 hours a day, as listed in the following tables:

Electronic support services

Service	Access
World Wide Web	From the Internet, you can reach EPSON's projector page at http://www.epson.com/mul_proj/
Presenters Online	Access tips, templates, training and more at http://www.presentersonline.com
EPSON Internet FTP Site	If you have Internet FTP capability, use your Web browser (or other software for FTP downloading) to log onto ftp.epson.com with the user name anonymous and your e-mail address as the password.

Automated telephone services

Service	Access
EPSON SoundAdvice SM	For pre-recorded answers to commonly asked questions about EPSON products 24 hours a day, seven days a week, call (800) 922-8911 .
EPSON FaxAdvice TM	Access EPSON's technical information library by calling (800) 922-8911 . You must provide a return fax number to use this service.
EPSON Referral Service	For the location of your nearest Authorized EPSON Reseller or Customer Care Center, call (800) 922-8911 .

Telephone Support Services

To use the EPSON PrivateLine Support service, call **1-800-637-7661** and enter the PIN on the EPSON PrivateLine Support card that came with your projector. This service is available free, 6 AM to 6 PM, Pacific Time, Monday through Friday, for the duration of your warranty period.

Additional technical support options:

- U.S.: **(562) 276-4394**, 6 AM to 8 PM, Pacific Time, Monday through Friday and 7 AM to 4 PM, Saturday
- Canada: **(905) 709-3839**, 6 AM to 8 PM, Pacific Time, Monday through Friday and 7 AM to 4 PM, Saturday

Toll or long distance charges may apply.

Before you call, please have the following information ready:

- Product name (EPSON PowerLite projector)
- Product serial number (located on the bottom of the projector)
- Computer configuration
- Description of the problem

You can purchase screens, carrying cases, or other accessories from EPSON Accessories at **(800) 873-7766** or visit our website at www.epsonsupplies.com (U.S. sales only). In Canada, please call **(800) 873-7766** for dealer referral.

6 Notices

This chapter includes safety instructions and other important information about your EPSON PowerLite projector.

Important Safety Instructions

Follow these safety instructions when setting up and using the projector:

- Do not place the projector on an unstable cart, stand, or table.
- Do not use the projector near water or sources of heat.
- Use attachments only as recommended.
- Use the type of power source indicated on the projector. If you are not sure of the power available, consult your dealer or power company.
- Place the projector near a wall outlet where the plug can be easily unplugged.

Placez le projecteur près d'une prise de contact où la fiche peut être débranchée facilement.

- Insert the projector's three-wire grounding-type plug into a properly grounded outlet. If you have a two-prong outlet, contact an electrician to replace it. Do not hold the plug with wet hands.
- Take the following precautions for the plug. Failure to comply with these precautions could result in sparks or fire: Do not insert the plug into an outlet with dust present. Insert the plug firmly into the outlet.

- Do not overload wall outlets, extension cords, or integral convenience receptacles. This can cause fire or electric shock.
- Do not place the projector where the cord can be walked on. This may result in fraying or damage to the plug.
- Unplug the projector from the wall outlet before cleaning. Use a damp cloth for cleaning. Do not use liquid or aerosol cleaners.
- Do not block the slots and openings in the projector case. They provide ventilation and prevent the projector from overheating. Do not operate the projector on a sofa, rug, or other soft surface, or in a closed-in cabinet unless proper ventilation is provided.
- Never push objects of any kind through cabinet slots. Never spill liquid of any kind into the projector.
- Except as specifically explained in this *User's Guide*, do not attempt to service this product yourself. Refer all servicing to qualified service personnel. Opening or removing covers may expose you to dangerous voltages and other hazards.
- Unplug the projector during lightning storms or when it will not be used for extended periods.
- Do not place the projector and remote control on top of heat-producing equipment or in a hot location.
- Unplug the projector from the wall outlet and refer servicing to qualified service personnel under the following conditions: When the power cord or plug is damaged or frayed. If liquid has been spilled into the projector, or if it has been exposed to rain or water. If it does not operate normally when you follow the operating instructions, or if it exhibits a distinct change in performance, indicating a need for service. If it has been dropped or the housing has been damaged.
- If you use the projector in a country other than where you purchased it, use the correct power cable for that country.

Remote Control Information

You can operate the projector by remote control via a line-of-sight infrared (IR) receiver at the front and rear of the projector. The projector may not respond to remote control commands under the following conditions:

- There is an object between the remote control IR emitter and the IR receiver on the projector.
- Ambient light is too bright.
- Certain types of fluorescent lighting are used.
- A strong light source shines into the IR receiver.
- Other equipment that emits infrared energy, such as a radiant room heater, is in the room.

These conditions commonly cause problems for most infrared-controlled equipment. Try the following:

- The remote control unit's batteries may be low on power; replace them.
- Dim the ambient lighting and/or turn off any fluorescent lights.
- Close any window coverings and/or move the projector out of direct sunlight.
- Turn off other equipment that emits infrared energy.

If the remote control still does not work properly, remember you can always control your computer-based presentation directly from the computer, even in an environment containing one of the conditions listed above.

Declaration of Conformity

According to 47CFR, Part 2 and 15

Class B Personal Computers and Peripherals; and/or
CPU Boards and Power Supplies used with Class B
Personal Computers

We: EPSON AMERICA, INC.
Located at: 3840 Kilroy Airport Way
MS: 6-43
Long Beach, CA 90806-2469
Tel: (562) 290-5254

Declare under sole responsibility that the product identified herein, complies with 47CFR Part 2 and 15 of the FCC rules as a Class B digital device. Each product marketed, is identical to the representative unit tested and found to be compliant with the standards. Records maintained continue to reflect the equipment being produced can be expected to be within the variation accepted, due to quantity production and testing on a statistical basis as required by 47CFR §2.909. Operation is subject to the following two conditions: (1) this device may not cause harmful interference, and (2) this device must accept any interference received, including interference that may cause undesired operation.

Trade Name: EPSON
Type of Product: LCD Projector
Model: EMP-710/700/500

FCC Compliance Statement

For United States Users

This equipment has been tested and found to comply with the limits for a Class B digital device, pursuant to Part 15 of the FCC Rules. These limits are designed to provide reasonable protection against harmful interference in a residential installation. This equipment generates, uses, and can radiate radio frequency energy and, if not installed and used in accordance with the instructions, may cause harmful interference to radio or television reception. However, there is no guarantee that interference will not occur in a particular installation. If this equipment does cause interference to radio and television reception, which can be determined by turning the equipment off and on, the user is encouraged to try to correct the interference by one or more of the following measures:

- Reorient or relocate the receiving antenna.
- Increase the separation between the equipment and receiver.
- Connect the equipment into an outlet on a circuit different from that to which the receiver is connected.
- Consult the dealer or an experienced radio/TV technician for help.

WARNING

The connection of a non-shielded equipment interface cable to this equipment will invalidate the FCC Certification of this device and may cause interference levels which exceed the limits established by the FCC for this equipment. It is the responsibility of the user to obtain and use a shielded equipment interface cable with this device. If this equipment has more than one interface connector, do not leave cables connected to unused interfaces. Changes or modifications not expressly approved by the manufacturer could void the user's authority to operate the equipment.

For Canadian Users

This Class B digital apparatus meets all requirements of the Canadian Interference-Causing Equipment Regulations.

Cet appareil numérique de la classe B respecte toutes les exigences du Règlement sur le matériel brouilleur du Canada.

Index

A

- A/V cable, 19
- A/V Mute button, 34, 57
- A/V Mute setting, 55
- About menu, 58
- Accessories, 72
- Adobe Acrobat Reader, 4 to 5
- Advanced menu, 46
- Air filter, cleaning, 61
- Anti-theft device, 22
- Arrow tool
 - customizing, 52
 - using, 37
- Audio
 - adjusting tone, 50 to 51
 - adjusting volume, 35, 50 to 51
 - connecting cable, 13, 17, 21
 - menu, 50 to 51
 - problems, 71
- Audio Out jack, 21
- Auto button, 49

B

- Bass, adjusting sound, 50 to 51
- Batteries, remote control, 9
- Blurry image, 70
- Box tool
 - customizing, 53
 - using, 37
- Brightness setting, 49

C

- Cable
 - audio, 13, 17
 - computer, 12, 15
 - mouse, 14, 17 to 18
- Camcorder, connecting, 19 to 20
- Case, cleaning, 60
- Cleaning
 - air filter, 61
 - lens, 60
 - projector, 60
- Color
 - adjusting, 49 to 50
 - problems, 70
- Comp button, 34
- Computer
 - connecting audio cable, 13, 17, 21
 - connecting mouse cable, 14, 17 to 18
 - connecting projector, 12 to 13, 15 to 17
- Computer cable, connecting, 12 to 13, 15 to 17
- Connecting projector
 - to external speakers, 21
 - to laptop computer, 12 to 13
 - to PowerBook, 15 to 17
 - to video source, 19 to 20
- Contrast setting, 49
- Cursor/stamp tool
 - customizing, 52
 - using, 37

D

Declaration of Conformity, 76
Digital camera, connecting, 19 to 20
Distance from projector to screen, 10
Documentation, 4 to 5
Drawing on the screen, 36 to 39
DVD player, connecting, 19 to 20

E

Effect menu, 51 to 54
Electronic manuals, 4 to 5
Enter button, 32
EPSON
 Accessories, 72
 PrivateLine Support, 3, 72
 technical support, 71 to 72
Esc button, 32, 37, 48
External speakers, connecting, 21
E-Zoom button, 33

F

FaxAdvice, EPSON, 72
Focus ring, 28
Focusing image, 28
Foot release levers, 29
Freehand line tool
 customizing, 53
 using, 39
Freeze button, 35
FTP site, EPSON, 71

G

Gamma setting, 49

H

Help, 3, 71 to 72
Help button, 41
Help system, using, 41 to 42

I

Image
 adjusting, 28 to 30
 blurry, 70
 capturing and saving in projector, 56 to 57
 color, 49
 correcting shape, 30, 54, 69
 fine-tuning appearance, 49
 focusing, 28, 70
 help, 41
 positioning, 29, 48 to 49
 problems, 68 to 70
 raising, 29
 resizing, 33
 size and distance from screen, 10
 turning off, 34
 zooming, 28, 33
Installing batteries in remote control, 9
Internet, 3, 71

K

Kensington anti-theft device, 22
Keystone button, 30, 69

L

Lamp
 automatic shut-off, 27, 55
 number of hours used, 58
 replacing, 62 to 64
 warning light, 40, 65 to 67
Language setting, 41
Laptop computer
 connecting audio cable, 13
 connecting mouse cable, 14
 connecting projector, 12 to 13
 displaying on, 23, 27
Laser disc player, connecting, 19 to 20
Lens
 cap, 23
 cleaning, 60
 extending, 22
 ring, 28
Light button, 31

Lights, status and warning, 40, 65 to 67
Lines, drawing on screen, 38, 39
Locating projector, 9 to 10
Logo, saving on projector, 56 to 57

M

MAC mouse cable, 17 to 18
Macintosh
 adapter, 16
 see also PowerBook
 video-out cable, 16
Manuals, 4 to 5
Marker tool
 customizing, 53
 using, 38
Menu button, 47
Menus
 About, 58
 Advanced, 46
 Audio, 50 to 51
 Effect, 51 to 54
 Setting, 54 to 55, 57
 User's Logo, 56 to 57
 using, 46 to 48
 Video, 47 to 50
Mouse cable, connecting, 14, 17 to 18

N

No-Signal Msg setting, 55
Notebook computer, *see* Laptop computer
Numbered buttons on remote control, 36

P

P in P button, 35
PA system, connecting, 21
Picture in picture, 35, 55
Positioning image, 29
Positioning projector, 9 to 10
Power
 button, 23, 42
 cord, 22
 light, 22 to 24, 40, 42
 saving, 27, 55

Power Mgmt Sys setting, 55
PowerBook
 connecting audio cable, 17
 connecting mouse cable, 17 to 18
 connecting projector, 15 to 17
 displaying on, 23, 27
Presentation tips, 2
PrivateLine Support, 3, 72
Projection lamp light, 40, 65 to 66
Projector
 cleaning, 60
 connecting to laptop, 12 to 13
 connecting to PowerBook, 15 to 17
 connecting to video source, 19 to 20
 connections, 11 to 12
 distance from screen, 10
 feet, 29
 focusing, 28
 positioning, 9 to 10
 problems, 65 to 67
 registering, 4
 shutting off, 24, 42
 status lights, 65 to 67
 transporting, 64
 turning on, 22, 26
 unpacking, 8
 viewing information, 58
Prompt setting, 55
PS/2 mouse cable/port, 14

R

Raising image, 29
RCA A/V cable, 19
Registering the projector, 4
Remote control
 connecting cable for wireless mouse, 14,
 17 to 18
 information, 75
 installing batteries, 9
 light button, 31
 problems, 67, 75
 turning on, 31
 using, 30 to 32
 using as wireless mouse, 32

Replacing the lamp, 62 to 64
Resetting menu options, 46, 48
Resize button, 33
Resizing
 image, 33
 problems, 69
Resolution, 1, 69

S

Safety instructions, 73 to 74
Screen image, problems, 68 to 70
Screen, distance from projector, 10
Setting menu, 54 to 55, 57
Sharpness setting, 49
Shutting down projector, 24, 42
SizeWise technology, 1
Sleep mode, 22, 27, 55
Sound
 adjusting volume, 35, 50 to 51
 help, 41
 problems, 71
 turning off, 34
Sound system, connecting, 21
Source button, 27
Source, selecting, 34
Speakers, connecting to, 21
Special effects buttons, 36 to 39
Stamp tool
 customizing, 52
 using, 37
Standard mouse port, 17 to 18
Startup screen, creating, 56 to 57
Status lights, 40, 65 to 67
Stereo audio cable, 21
Stopping action, 35
Support, 3, 71 to 72
S-video, 19, 20
S-Video button, 34
Sync, 48, 70

T

Technical support, 3, 71 to 72
Temperature warning light, 40, 65 to 67
Tone setting, 50 to 51

Tracking, 48, 70
Transporting the projector, 64
Trapezoid image, 30, 54, 69
Treble, adjusting sound, 50 to 51
Troubleshooting
 color problems, 70
 image and sound problems, 68 to 71
 projector problems, 65 to 67
 remote control problems, 67 to 68
Turning off projector, 24, 42
Turning on projector, 22, 26

U

Unpacking projector, 8
USB mouse cable/port, 14, 17 to 18
User's Logo menu, 56 to 57

V

VCR, connecting, 19 to 20
Video
 button, 34
 display settings, viewing, 58
 jack, 19
 menu, 47 to 50
 picture in picture, 35, 55
 selecting source, 34
Video source, connecting, 19 to 20
Video-out cable for PowerBook, 16
Volume
 button, 35
 setting, 50 to 51

W

Warning lights, 40, 65 to 67
World Wide Web, 3, 71

Z

Zoom ring, 28
Zooming image, 28, 33