

EPSON® PowerLite® 30c Multipurpose Entertainment Projector



User's Guide

EPSON
PowerLite

Important Safety Information

WARNING: Never look into the projector lens when the lamp is turned on; the bright light can damage your eyes. Never let children look into the lens when it is on. Never open any cover on the projector, except the lamp and filter covers. Dangerous electrical voltages inside the projector can severely injure you. Except as specifically explained in this *User's Guide*, do not attempt to service this product yourself. Refer all servicing to qualified service personnel.

WARNING: The projector and its accessories come packaged in plastic bags. Keep plastic bags away from small children to avoid any risk of suffocation.

Caution: When you replace the lamp, never touch the new lamp with your bare hands; the invisible residue left by the oil on your hands may shorten the lamp life. Use a cloth or glove to handle the new lamp.

See also *Important Safety Instructions* starting on p.44.

Copyright Notice

Copyright © 2002 by SEIKO EPSON CORPORATION

All rights reserved. No part of this publication may be reproduced, stored in a retrieval system, or transmitted in any form or by any means, electronic, mechanical, photocopying, recording, or otherwise, without the prior written permission of SEIKO EPSON CORPORATION. The information contained herein is designed only for use with this EPSON product. EPSON is not responsible for any use of this information as applied to other products.

Neither SEIKO EPSON CORPORATION nor its affiliates shall be liable to the purchaser of this product or third parties for damages, losses, costs, or expenses incurred by purchaser or third parties as a result of: accident, misuse, or abuse of this product or unauthorized modifications, repairs, or alterations to this product, or (excluding the U.S.) failure to strictly comply with SEIKO EPSON CORPORATION's operating and maintenance instructions.

SEIKO EPSON CORPORATION shall not be liable for any damages or problems arising from the use of any options or any consumable products other than those designated as Original EPSON Products or EPSON Approved Products by SEIKO EPSON CORPORATION.

EPSON is a registered trademark of SEIKO EPSON CORPORATION.

EPSON Connection is a service mark, and PrivateLine and PowerLite are registered trademarks of Epson America, Inc.

General Notice: Other product names used herein are for identification purposes only and may be trademarks of their respective owners. EPSON disclaims any and all rights in those marks.

About the Documentation

Types of Documentation

Your EPSON projector comes with the following documentation.



① Quick Setup Poster

This poster quickly tells you how to unpack the projector and get started using it.

② User's Guide (this manual)

This *User's Guide* contains information on basic operation, using the configuration menus, troubleshooting and maintenance.

Conventions Used in This User's Guide

	Indicates actions where personal injury or damage to the projector may occur if the procedures are not followed correctly.
	Indicates additional information and things that can be useful to know.
	Indicates that an explanation of the underlined word or words in front of the symbol appears in the glossary of terms. See Glossary in the Appendix. (p.61)
Procedure	Indicates steps you take to accomplish tasks. The steps should be followed in the order given.

Getting More Information

If you need help not covered in the documentation, try the following:

- Built-in help system

Provides assistance for common problems. Available from the Help button on the projector or the remote control (see p.34).

- <http://support.epson.com>

Download FAQs and e-mail your questions to EPSON support. Take advantage of EPSON's automated support services 24 hours a day.

- EPSON PrivateLine support service

To get help fast from EPSON, call (800) 637-7661 and enter the PIN on the PrivateLine[®] Technical Support card in your owner's kit.

Features of the Projector

Cinema filter function

You can boost the quality of films by attaching the EPSON cinema filter supplied with the projector, and then changing the Cinema Filter setting in the Video menu to ON. This automatically causes video images such as films to be projected at the optimum tint.

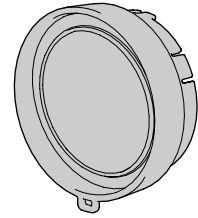

Color mode function

The optimum images can be projected simply by selecting the image quality from the following six preset settings according to the projection environment being used. No other color adjustments are necessary.

- sRGB
- Normal
- Meeting
- Presentation
- Theatre
- Game

Brilliant, attractive images

Despite its compact size, the projector can display images at high resolutions with a high degree of luminance, providing beautifully clear images even in bright environments.

Keystone correction function

Keystone distortion in projected images can be corrected easily. This feature makes images project correctly even when the projector has been set up on a tilted vertical angle.

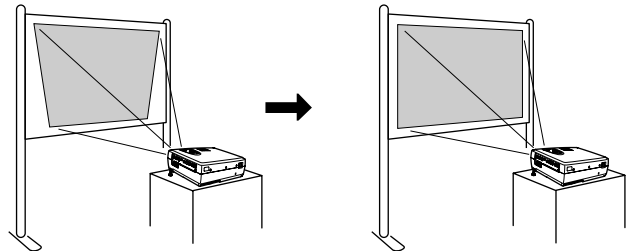

Automatic setup function

When projecting computer images, the signals from the connected computer are detected automatically and adjusted so that the optimum images are projected. Even if several people are giving presentations using the same projector, the optimum picture quality can be obtained simply by disconnecting and reconnecting the computers. Each individual setting can also be adjusted manually.

Easy to operate

The accessory remote control can be used for operations such as pausing projection and zooming in on important areas of an image.



Contents

About the Documentation	3
Types of Documentation	3
Conventions Used in This User's Guide	3
Getting More Information	3
Features of the Projector	4
Contents.....	5
Basic Operations	7
Turning On the Projector.....	8
Connecting the Power Cable	8
Turning On the Power and Projecting Images	9
Turning Off the Projector.....	10
Adjusting the Screen Image.....	12
Adjusting the Image Size	12
Focusing the Screen Image	12
Adjusting the Image Angle.....	13
Correcting Keystone Distortion	14
Adjusting Image Quality	15
Using the EPSON Cinema Filter.....	15
Selecting the Color Mode	16
Wide-Screen Projection of Component Video and Video Images	16
Adjusting Computer Images	17
Settings and Useful Functions	21
Using the Configuration Menu Functions.....	22
Video Menu.....	22
Audio Menu.....	25
Setting Menu.....	25
Advanced Menu	26
About Menu	27
Reset All Menu	28
Using the Configuration Menus.....	29
Useful Functions When a Computer Is Connected.....	31
A/V Mute	31
Freeze.....	31
E-Zoom	32
Troubleshooting.....	33
Using the Help Function.....	34
When Having Trouble	35
(Warning) Indicator	35
Power Indicator	36
When the Indicators Provide No Help.....	37
Appendix	43
Important Safety Instructions	44
Maintenance	46
Cleaning.....	46
Replacing Consumables	47
Optional Accessories	52
List of Supported Monitors	53
Component Video Input/RGB Video Input	53
Composite Video/S-Video Input.....	53
Computer	53
Specifications.....	54
Safety.....	55

Appearance.....56
Part Names and Functions57
 Front/Top57
 Control Panel58
 Left Side.....58
 Rear59
 Base.....59
 Remote Control.....60
Glossary61
Index63
Warranty65
Declaration of Conformity67
FCC Compliance Statement68

Basic Operations

This chapter describes basic operations such as turning the projector on and off and adjusting the projected images.

Turning On the Projector	8
Connecting the Power Cable.....	8
Turning On the Power and Projecting Images	9
Turning Off the Projector	10
Adjusting the Screen Image	12
Adjusting the Image Size.....	12
Focusing the Screen Image.....	12
Adjusting the Image Angle	13
Correcting Keystone Distortion	14
Adjusting Image Quality	15
Using the EPSON Cinema Filter.....	15
Selecting the Color Mode	16
Wide-Screen Projection of Component Video and Video Images	16
Adjusting Computer Images	17
Automatic Setup.....	17
Adjusting the Tracking.....	18
Adjusting the Sync	19



Turning On the Projector



Be sure to read the *Important Safety Instructions* starting on p.44 before projecting images.

Connecting the Power Cable

Procedure

1

Make sure the power is off for all components connected to the projector.

2

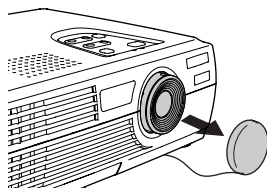

Remove the lens cover.

3

Connect the video source or computer to the projector (see *Quick Setup*).

4

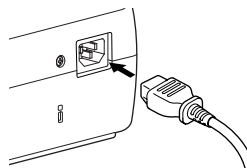

Connect the power cord to the projector.

Check that the power cord connector is facing the same way as the power inlet on the projector, and then insert the power cord securely into the projector.

5

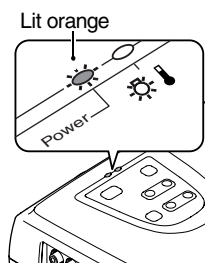

Connect the other end of the power cord to a grounded electrical outlet.

Wait until the Power indicator lights orange.



The projector's control panel and remote control buttons cannot be operated while the Power indicator is flashing orange.

Turning On the Power and Projecting Images

Procedure

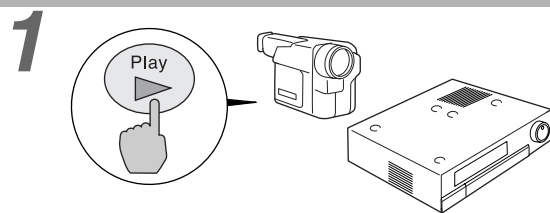

Turn on the power for all equipment connected to the projector.

For a video source, press the [Play] button at the video source to start playback if necessary. Check that the Power indicator has stopped flashing and lights orange.

2 Changes from flashing to lit green

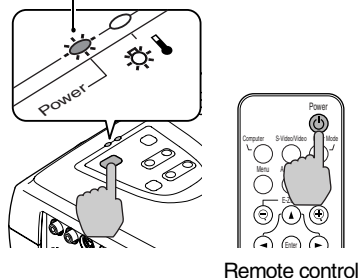

Press the [Power] button on either the projector's control panel or the remote control to turn on the power for the projector.

The Power indicator flashes green, and after a short period it stops flashing and projection starts. Wait until the Power indicator lights green (it normally takes about 40 seconds to change).



The projector's control panel and remote control buttons cannot be operated while the Power indicator is flashing green. Depending on the settings, the message "No-Signal" can appear. See Setting - No-Signal Msg. (p.25)

3 If more than one signal source has been connected, use the projector's control panel or the remote control to select a port, while referring to the following table.

Port	Button to press		Display at top right of screen
	Projector	Remote control	
Computer/ Component Video	The image source changes each time [Source] is pressed.	[Computer]	Computer * YCbCr▶▶ * YPbPr ▶▶ *
S-Video		[S-Video/Video]	S-Video
Video			Video

*The message displayed depends on which Input Signal option has been selected in the Video menu.



- If only one signal source has been connected, that source will be projected without any buttons being pressed.
- If the No-Signal message does not disappear, check the connections again.
- If a laptop computer or a computer with an LCD screen has been connected to the projector, the images may not be projected immediately. After making the connections, check that the computer has been set up to output signals externally. The following table shows examples of how to toggle output settings. For details, refer to the section of the documentation provided with your computer under a heading such as "External output," "Connecting an external monitor" or something similar.

NEC	Panasonic	Toshiba	IBM	Sony	Fujitsu	Macintosh
[Fn]+[F3]	[Fn]+[F3]	[Fn]+[F5]	[Fn]+[F7]	[Fn]+[F7]	[Fn]+[F10]	After startup, change the Control Panel adjustments so that Mirroring is active

- If the same still picture is projected for a long period of time, the projected image may become burned into the computer screen. You should avoid leaving the same image displayed for long periods.

Turning Off the Projector

Follow the procedure below to turn off the projector's power.

Procedure

1

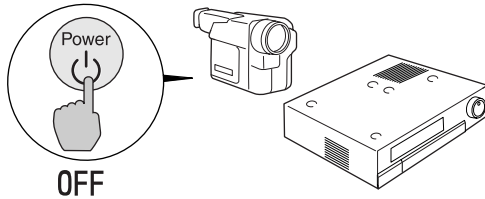

Turn off the power for the signal sources that are connected to the projector.

Check that the power for all connected components has been turned off.

2

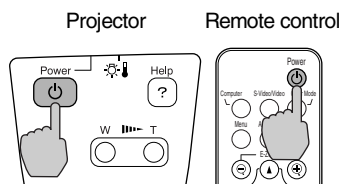

Press the [Power] button on either the projector's control panel or the remote control.

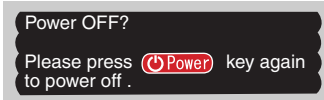

The confirmation message shown to the left will appear. If you do not want to turn off the power, press any button except the [Power] button. If you do not press any button, the message will disappear automatically after seven seconds. (In this case, the power will not turn off.)

3

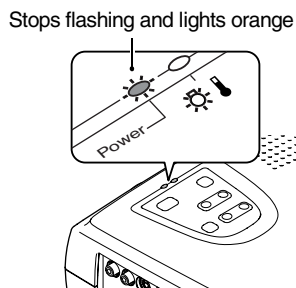

Press the [Power] button once more.

The lamp will switch off. The Power indicator will flash orange and cool-down will start. The cool-down period lasts for about 25 seconds. (This varies depending on factors such as the ambient air temperature.) When cool-down is complete, the Power indicator lights orange.

 The projector's control panel and remote control buttons cannot be operated while the Power indicator is flashing orange. Wait until it lights steadily.

4

Unplug the power cable from the electrical outlet.



Do not disconnect the power cable from the outlet while the Power indicator is still flashing orange, because it may result in projector operation errors and reduced lamp unit operating life.

5

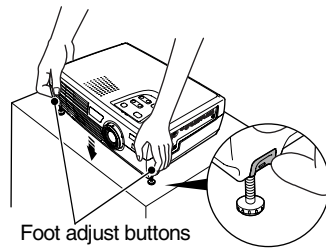

Retract the front adjustable feet if they are extended.

Gently push down on the projector while simultaneously pressing the two foot adjust buttons.

6

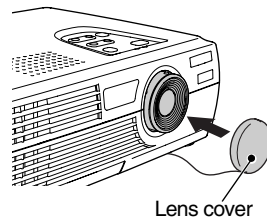

Attach the lens cover.

Attach the lens cover to the lens when not using the projector to keep dust and dirt off the lens.

Adjusting the Screen Image

You can correct and adjust the screen image to obtain the best possible picture.

Adjusting the Image Size

The size of the projected image is basically determined by the distance from the projector to the screen. (*Quick Setup* poster)

If further minor adjustment is required, press the [Zoom] button on the projector's control panel to make the adjustment. Minor adjustments can be made to the image size to between a zoom ratio of approximately 1.0 to 1.2 in 33 steps.

 The E-Zoom function lets you enlarge parts of the image. (p.32)

Procedure

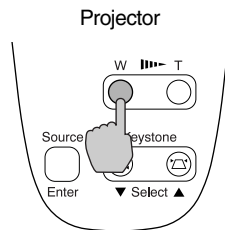
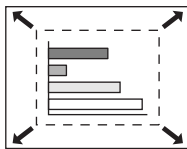

Press the [Zoom] button on the projector's control panel.

When pressed to the [W] side, the image becomes larger.

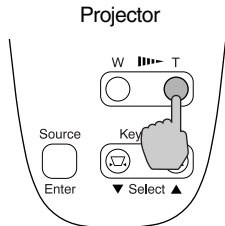
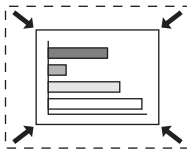

When pressed to the [T] side, the image becomes smaller.

Focusing the Screen Image

Procedure

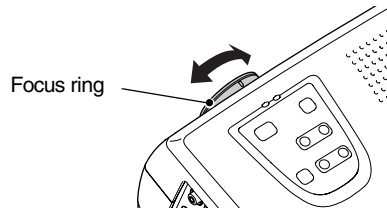

Turn the focus ring to adjust the image focus.



- If the surface of the lens is dirty or has condensation on it, it may not be possible to adjust the focus correctly. If this happens, clean the lens. (p.38, 46)
- If the projector is positioned outside the normal projecting range of 0.9–11.3 m (2.9–37.0 ft.), it may not be possible to get the correct focus. If you have trouble getting the correct focus, check the projection distance.

The projector should be set up so it is as perpendicular to the screen as possible.

Seen from the side

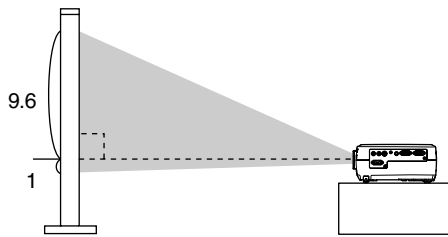

Seen from above

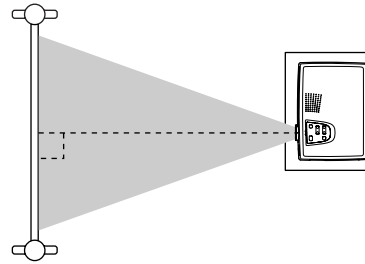

If it is not possible to set up the projector so it is perpendicular to the screen, it can be set up at a slight vertical angle instead. You can extend or retract the front adjustable feet to adjust the projection angle within a maximum range of 10°.

Procedure

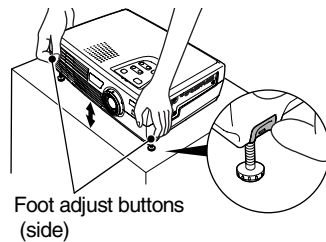

Foot adjust buttons (side)

While pressing the two foot adjust buttons at either side, lift up the front of the projector so that the front adjustable feet can extend.

Extend the front adjustable feet until the desired angle is obtained, and then release the foot adjust buttons.

To retract the front adjustable feet, gently push down on the projector while pressing the two foot adjust buttons.



- When the feet are adjusted, it may cause distortion in the projected image. Use the keystone correction function to adjust this distortion. (p.14)
- If the projector is tilted horizontally, turn the bases of the front adjustable feet to adjust the angle.

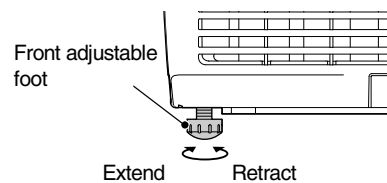

Correcting Keystone Distortion

When the projector is tilted, it will cause keystone distortion to appear in the image. This distortion can be corrected using the keystone correction function, as long as the vertical angle of tilt is within a range of approximately 15°.

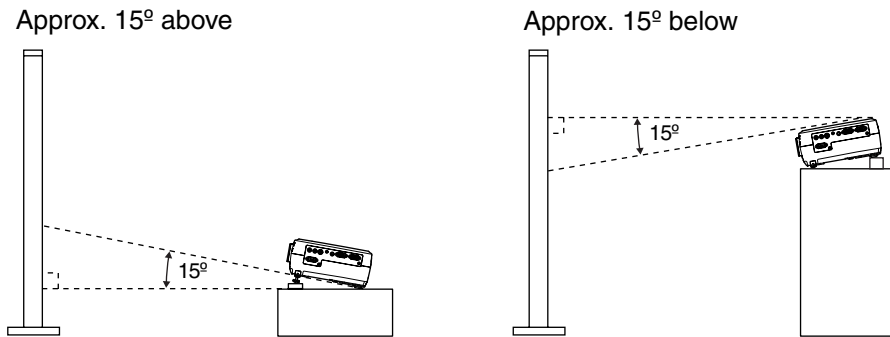

Procedure

Keystone correction can be carried out using either the projector's control panel or the configuration menu. The following explanation describes how to correct keystone correction using the projector's control panel. For adjustment using the configuration menu: Setting - Keystone (p.25)

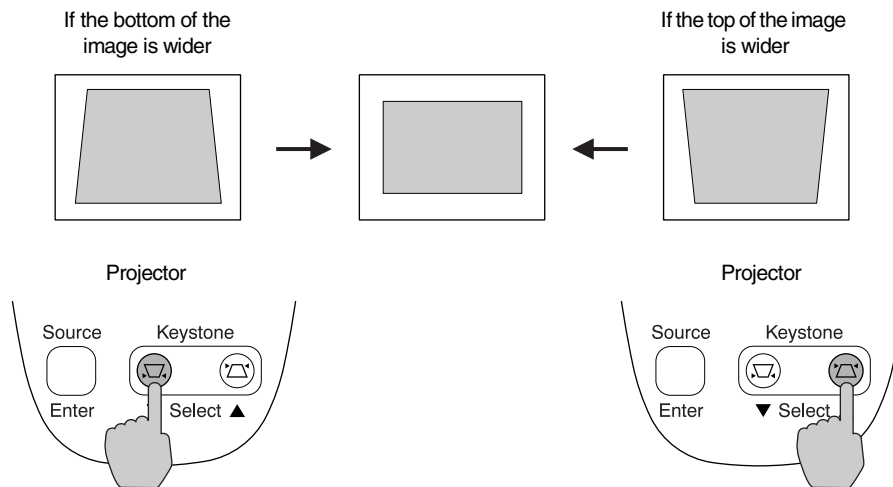

- When keystone correction is used, the projected image will become smaller.
- The keystone correction settings are memorized. If you change the position or angle of the projector, you may need to readjust the keystone correction settings.
- If the images become uneven in appearance after keystone correction is carried out, decrease the sharpness setting. (p.23, 24)
- If the value displayed in the gauge on the screen stops changing when keystone correction is being carried out, it indicates that the limit for keystone correction has been exceeded. Check that the projector has not been set up at an angle that exceeds the proper limit.

Adjusting Image Quality

The quality of the screen image can be adjusted as described in the following sections.

Using the EPSON Cinema Filter

When you attach the EPSON cinema filter to the projector and set the EPSON Cinema Filter command to ON, the images are adjusted to the optimum tint for movie theater images.

If you do this when a computer is connected and the projector is being used for a presentation, the image will appear darker than normal, so remove the cinema filter and change the EPSON Cinema Filter setting to OFF.

Procedure

1

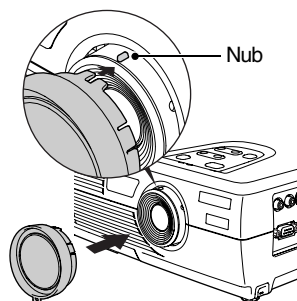

Attach the cinema filter.

Align the nub on the focus ring with the notch in the cinema filter, and then attach the cinema filter.



- The EPSON cinema filter should always be installed so that the notch is aligned with the nub on the focus ring. If the cinema filter is not installed correctly, unevenness or lack of focus may occur in the projected image.
- Do not touch the glass surfaces of the cinema filter or the projector's lens when attaching the cinema filter. If fingerprints or smears get on the glass surfaces, it will reduce the clarity of the projection.

2

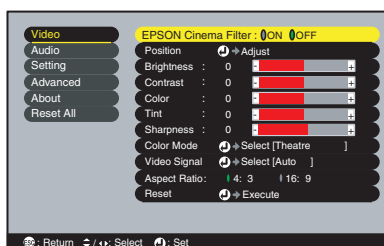

Press the [Menu] button on the remote control, and then select EPSON Cinema Filter from the Video menu.

For details on this operation, refer to “Using the Configuration Menus.” (p.29)

3

Select ON and then press the [Enter] button.

4

After changing the setting, press the [Menu] button to exit the configuration menu.

Selecting the Color Mode

The following six preset color modes are available. Which one you use depends on the characteristics of the images you want to project. You can easily obtain the optimum image quality by selecting the color mode that corresponds to the projected image. The brightness of the image will vary depending on the color mode you select.

Mode	Application
sRGB▶▶	Images conform to the sRGB color standard. If the connected source has an sRGB mode, set both the projector and the connected signal source to sRGB.
Normal	Brightness is emphasized for presentation in bright rooms.
Meeting	Images are modulated using their original tints, with no color enhancement.
Presentation	For presentation in dark rooms.
Theater	Movie images are optimized using natural tints.
Game	Brightness is emphasized. Ideal for playing video games in bright rooms.

Procedure

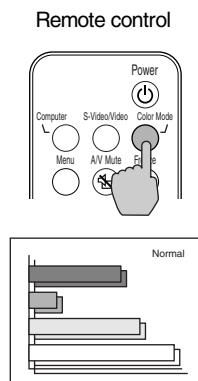

The color mode changes in the following order as you press the [Color Mode] button on the remote control:

Normal → Meeting → Presentation → Theater
→ Game → sRGB

The current setting appears in the top right corner of the screen each time the color mode is changed.

The default color mode setting is Normal when computer image signals are being input, and Theater when component video▶▶ or video signals are being input.



You can also set the color mode by using the Color Mode command in the Video menu. (p.23, 24)

Wide-Screen Projection of Component Video and Video Images

This function changes the aspect ratio▶▶ of images from 4:3 to 16:9 when component video images (YCbCr and YPbPr) or video images (S-Video or composite video) are being projected. Images which have been recorded in digital video or onto DVDs can be viewed in 16:9 wide-screen format.

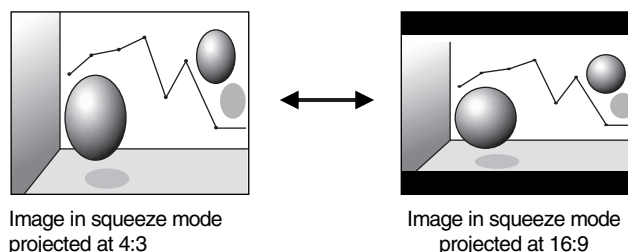

Procedure

1



Press the [Menu] button on the remote control, and then select **Aspect Ratio** from the Video menu.

For details on this operation, refer to “Using the Configuration Menus.” (p.29)

2

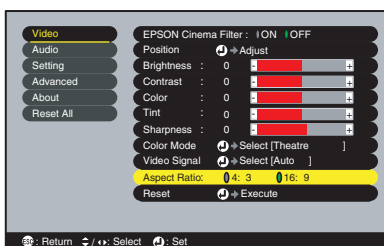

Press the [◀] and [▶] buttons to set the aspect ratio to either 4:3 or 16:9, and then press the [Enter] button.

3

After making the adjustment, press the [Menu] button to exit the configuration menu.

Adjusting Computer Images

Automatic Setup

Automatic setup detects the status of the signals coming from the connected computer and automatically adjusts these signals so the optimum image quality can be obtained. Automatic setup involves adjustment of the following three items: Tracking▶▶, Position and Sync▶▶.



- If Auto Setup in the Video menu is set to OFF (the default setting is ON), automatic setup is not carried out. If you press the [Auto] button on the remote control while computer signals are being projected, adjustment will then be carried out.

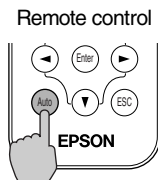

- If you press the [Auto] button while the E-Zoom or Freeze function is being used, or while a configuration menu or help menu is being displayed, the function will be cancelled when you press the [Auto] button, and then the adjustment will be carried out.
- Sometimes the signals may not be adjusted correctly, depending on the type of signals being output by the computer. In such cases, use the configuration menu commands to adjust the tracking and sync settings manually. (p.18, 19)

Adjusting the Tracking

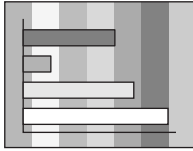

If vertical stripes appear in the projected images and this cannot be fixed using automatic setup, adjust the tracking manually using the following procedure.

Procedure

1

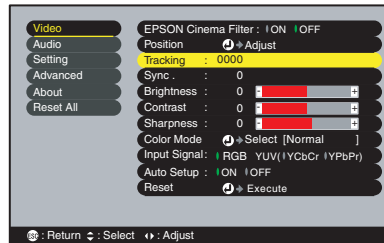

Press the [Menu] button on the remote control, and then select Tracking from the Video menu.

For details on this operation, refer to “Using the Configuration Menus.” (p.29)

2

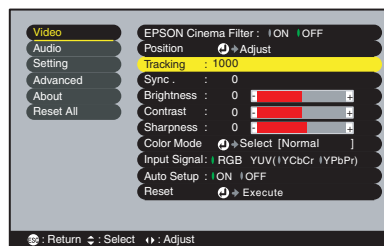

Press the [◀] and [▶] buttons to set the tracking value.

The tracking value increases or decreases each time a button is pressed.

3

After making the adjustment, press the [Menu] button to exit the configuration menu.



The image will flash when continuous tracking adjustment is carried out.

Adjusting the Sync

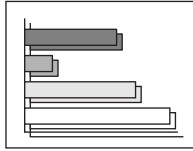

If flickering, fuzziness or interference appear in images that are input from the computer, and this cannot be fixed using automatic setup, adjust the **sync** manually using the following procedure.

Procedure

1



Press the [Menu] button on the remote control, and then select Sync from the Video menu.

For details on this operation, refer to “Using the Configuration Menus.” (p.29)

2

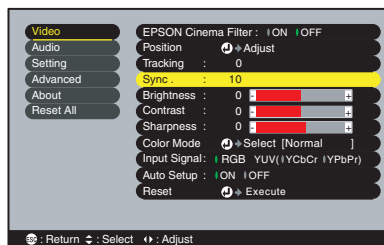

Press the [◀] and [▶] buttons to set the sync value.

The sync value increases or decreases each time a button is pressed.

3 After making the adjustment, press the [Menu] button to exit the configuration menu.



- If you adjust the sync without adjusting the tracking first, it will not be possible to get the best adjustment results. Incorrect tracking adjustment may not be noticeable with some types of picture. However, pictures with lots of lines and shading will tend to show incorrect tracking adjustments more clearly, so be sure to check the tracking adjustment first.
- It may also be possible to fix flickering and fuzziness by adjusting the brightness, **contrast**, sharpness and keystone correction settings.

Settings and Useful Functions

This chapter describes the configuration menus and useful functions that can be used when a computer is connected.

Using the Configuration Menu Functions.....22

Video Menu	22
Video (S-Video, Composite video, Component)	22
Computer (Analog-RGB)/RGB video	24
Audio Menu.....	25
Setting Menu.....	25
Advanced Menu.....	26
About Menu.....	27
Reset All Menu.....	28
Using the Configuration Menus.....	29

Useful Functions When a Computer

Is Connected	31
A/V Mute	31
Freeze	31
E-Zoom	32



Using the Configuration Menu Functions

The configuration menus can be used to carry out a variety of settings and adjustments. The menus have a hierarchical structure, with a main menu that is divided into sub-menus, which are further divided into other sub-menus. The remote control is used to operate the menus. Refer to “Using the Configuration Menus” (p.29) for details on using the menus.

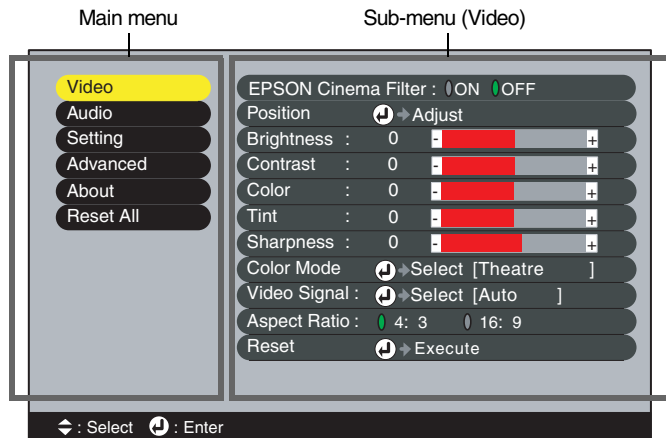

Video Menu

- The functions in the Video menu other than EPSON Cinema Filter, Input Signal, Auto Setup and Video Signal cannot be adjusted when no image signal is being input.
- The functions that appear in the Video menu change depending on the type of input source being used for the image signal. Functions that are not available in the Video menu for a particular input source cannot be adjusted.

Video (S-Video, Composite video, Component)

Video (S-Video, Composite video)



Component (YCbCr, YPbPr)

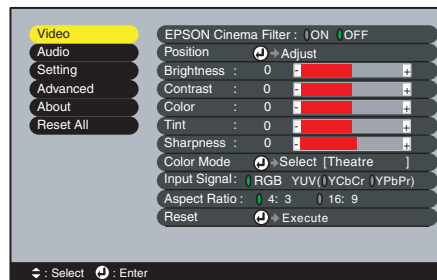

Video Menu

Sub-menu	Function	Default
EPSON Cinema Filter	This turns the function on and off for automatically adjusting signals to the optimum tint for movie images. When set to ON, the proper effect will not be obtained unless the EPSON cinema filter is attached to the lens of the projector. (p.15)	OFF
Position	Moves the image display position vertically and horizontally. • Press the [Enter] button and make the adjustment using the display position adjustment sub-menu that appears.	Depends on connection
Brightness	Adjusts the image brightness.	Median value (0)
<u>Contrast</u> ▶▶	Adjusts the difference between light and shade in the images.	Median value (0)
Color	(Not available for RGB video) Adjusts the color intensity for the image.	Median value (0)



Sub-menu	Function	Default
Tint	(Not available for RGB video) (Adjustment is possible only when <u>component video</u> ▶▶ or NTSC signals are being input.) Adjusts the image tint.	Median value (0)
Sharpness	Adjusts the image sharpness.	Median value (0)
Color Mode	Corrects the vividness of the image color. The settings can be saved separately for each type of source (video source or computer). You can select from six different quality settings depending on the surroundings. <ul style="list-style-type: none"> • <u>sRGB</u>▶▶ Images conform to the sRGB standard.* • Normal Brightness is emphasized for presentation in bright rooms. • Meeting Images are modulated using their original tints, with no color enhancement. • Presentation For presentations in dark rooms. • Theater Movie images are optimized using natural tints. The black and white extension function operates so that differences in color gradations (darkness and lightness of colors) are accentuated even for images that are very dark or very bright, to make them easier to view. • Game Brightness is emphasized. Ideal for playing video games in bright rooms. 	Theater
Video Signal	(Adjustment is possible only when composite video/S-Video signals are being input.) Sets the video signal format. <ul style="list-style-type: none"> • Press the [Enter] button, and choose the setting from the video signal format selection sub-menu that appears. • When set to Auto, the video signal format is set automatically. 	Auto
Input Signal	(Adjustment is only possible when component video signals are being input.) Selects the input source to be used.	Depends on connection
<u>Aspect Ratio</u> ▶▶	Sets the aspect ratio for projected images.	Depends on connection
Reset	Resets all values for Video menu functions (except EPSON Cinema Filter, Input Signal and Video Signal) to their default settings. <ul style="list-style-type: none"> • Press the [Enter] button to display the confirmation screen, and select Yes. • Select Reset All to return all menu settings to their default settings. (p.28) 	-

* If set to sRGB, the color temperature for the Color Adjustment command in the Advanced menu will be set to 6500K.

Computer (Analog-RGB)/RGB video

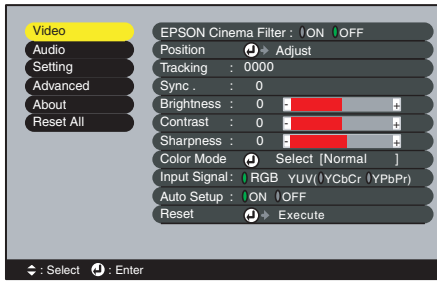

Video Menu

Sub-menu	Function	Default
EPSON Cinema Filter	This turns on and off the function for automatically adjusting signals to the optimum tint for movie images. When set to ON, you must also attach the EPSON cinema filter to the lens to obtain the proper effect. (p.15)	OFF
Position	Moves the image display position vertically and horizontally. • Press the [Enter] button and make the adjustment using the sub-menu that appears.	Depends on connection
<u>Tracking</u> ▶▶	Adjusts computer images when vertical stripes appear in the images.	Depends on connection
<u>Sync</u> ▶▶	Adjusts computer images when flickering, fuzziness or interference appear in the images. • Flickering and fuzziness may also appear when the brightness, <u>contrast</u> ▶▶, sharpness or keystone settings are adjusted. • You will obtain the best results if you adjust the tracking first, and then adjust the sync.	Depends on connection
Brightness	Adjusts image brightness.	Median value (0)
<u>Contrast</u> ▶▶	Adjusts the difference between light and shade in the image.	Median value (0)
Sharpness	Adjusts image sharpness.	Median value (0)
Color Mode	Corrects the vividness of the image color. The settings can be saved separately for each type of source (video source or computer). Select from six different quality settings, depending on the surroundings. • <u>sRGB</u> ▶▶ Images conform to the sRGB standard.* • Normal Brightness is emphasized for presentation in bright rooms. • Meeting Images are modulated using their original tints with no color enhancement. • Presentation For presentations in dark rooms. • Theater Movie images are optimized using natural tints. • Game Brightness is emphasized. Ideal for playing video games in bright rooms.	Normal
Input Signal	Selects the input source to be used. • Select RGB when projecting computer images or RGB video images.	Depends on connection
Auto Setup	Turns on or off the automatic adjustment function for automatically optimizing images when the input source is changed.	ON
Reset	Resets all values for Video menu functions (except EPSON Cinema Filter, Input Signal and Video Signal) to their default settings. • Press the [Enter] button to display the confirmation screen, and select Yes. • Select Reset All to return all menu settings to their default settings. (p.28)	-

* If set to sRGB, the color temperature for the Color Adjustment command in the Advanced menu will be set to 6500K.

Audio Menu

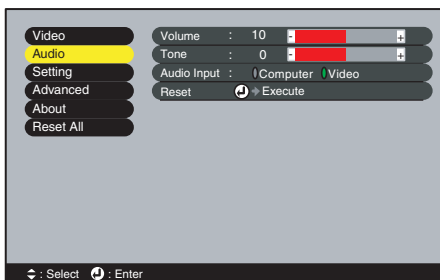

Sub-menu	Function	Default
Volume	Adjusts the volume.	Median value (10)
Tone	Adjusts the tone.	Median value (0)
Audio Input	Selects the input source for audio signals. The default setting varies depending on the type of signal being input (for component video, RGB video and computer input signals: Computer; for video input signals: Video). Therefore, if audio signals are being input to a different port from the default port, you need to select the audio signal input source. <ul style="list-style-type: none"> • Computer Audio signals will be input to the stereo mini jack (left side). • Video Audio signals will be input to the RCA pin jack (left side). 	Depends on connection
Reset	Resets all values for the Audio menu to their default settings. <ul style="list-style-type: none"> • Press the [Enter] button to display the confirmation screen, and select Yes. • Select Reset All to return all menu settings to their default settings. (p.28) 	-



The Audio menu settings are saved individually for each input signal source.

Setting Menu

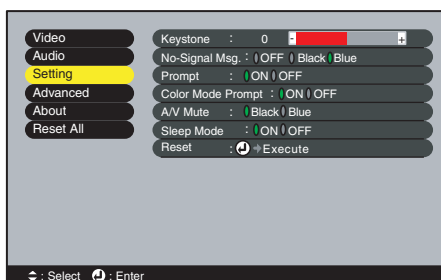

Sub-menu	Function	Default
Keystone	Corrects vertical keystone distortion in images. <ul style="list-style-type: none"> • When keystone correction is carried out, the projected image will become smaller. • If the images become uneven in appearance after keystone correction is carried out, decrease the sharpness setting. 	Median value (0)
No-Signal Msg.	Sets the message status and background color that displays in certain situations, such as when no image signal is being input. When set to OFF, the background color is black and no message is displayed.	Blue
Prompt	Controls whether the input signal name is displayed on the screen when the input signal is changed.	ON

Sub-menu	Function	Default
Color Mode Prompt	Controls whether the color mode prompt is displayed on the screen when the color mode is changed.	ON
A/V Mute	Sets the appearance of the screen when the [A/V Mute] button on the remote control is pressed.	Black
Sleep Mode	Sets the energy saving operation when no signal is being input. <ul style="list-style-type: none"> • When set to ON, projection stops automatically, and then after the <u>cool-down</u> period, if no operations are carried out for 30 minutes, the projector goes into sleep mode. The Power indicator lights orange. • Projection starts again when you press the [Power] button on the projector's control panel or the remote control. 	ON
Reset	Resets all values for the Setting menu to their default settings. <ul style="list-style-type: none"> • Press the [Enter] button to display the confirmation screen, and select Yes. • Select Reset All to return all menu settings—including settings for the Video and Audio menus—to their default settings. (p.28) 	-

Advanced Menu



Sub-menu	Function	Default
Language	Sets the language for message displays. <ul style="list-style-type: none"> • Press the [Enter] button and select the language from the selection menu that appears. 	English
Color Adjustment	Adjusts the <u>color temperature</u> and intensity of each RGB color for each input source. <ul style="list-style-type: none"> • Color Temp. Lets you adjust bright colors within a range from reddish tinges to bluish tinges. If the color temperature is lower, colors appear reddish and color tones appear softer. If the color temperature is higher, colors appear bluish and color tones appear sharper. Press the [Enter] button and make the adjustment in the sub-menu that appears. • RGB Sets the color intensity for each RGB (red/green/blue) color in the image. Press the [Enter] button, select R (red), G (green) or B (blue) and make the adjustment in the sub-menu that appears. You can adjust the colors while viewing the results on the screen. (This item cannot be selected if sRGB has been selected as the Color Mode setting in the Video menu.) 	Color Temp.: Depends on connection
Rear Proj.	Use when projecting images from behind a translucent screen. When set to ON, the projected images are horizontally reversed.	OFF
Ceiling	Use when installing the projector on the ceiling. When set to ON, the projected images are horizontally and vertically reversed.	OFF

Sub-menu	Function	Default
Reset	Resets all Advanced menu values (except for Language) to their default settings. <ul style="list-style-type: none"> • Press the [Enter] button to display the confirmation screen, and select Yes. • Select Reset All to return all menu settings including settings for the Video and Audio menus to their default settings. (p.28) 	-

About Menu

- The About menu shows the setting for the current image source.
- The Lamp item appears as 0H for 0–10 hours, and after that, it appears in units of 1 hour.

Video (S-Video, Composite video)

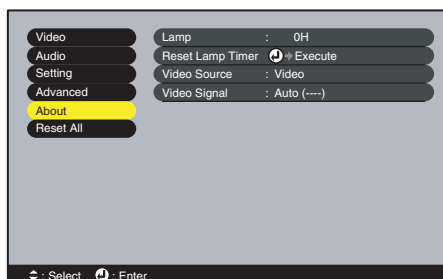

Computer/RGB video/Component video
(Analog-RGB, YCbCr, YPbPr)

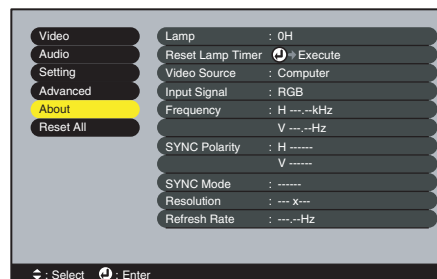

Sub-menu	Function	Default
Lamp	Displays the cumulative lamp operating time. <ul style="list-style-type: none"> • When the lamp warning period is reached, the display characters appear in red. 	0H
Reset Lamp Timer	Initializes the lamp operating time. When this command is selected, the cumulative lamp operating time is reset to the initial default value.	-
Video Source	Displays the input source that is currently being projected.	
Video Signal	Shows the video signal format. (Does not appear when the input source is component video, RGB video or computer.)	-
Input Signal	Displays the input signal settings. (Does not appear when the input source is composite video or S-Video.)	
Frequency	Displays the horizontal and vertical scanning frequencies. (Does not appear when the input source is composite video or S-Video.)	-
SYNC Polarity	Displays the sync polarity. (Does not appear when the input source is composite video or S-Video.)	-
SYNC Mode	Displays the sync attributes. (Does not appear when the input source is composite video or S-Video.)	-
Resolution	Displays the input resolution. (Does not appear when the input source is composite video or S-Video.)	-
Refresh Rate	Displays the refresh rate. (Does not appear when the input source is composite video or S-Video.)	-

Reset All Menu

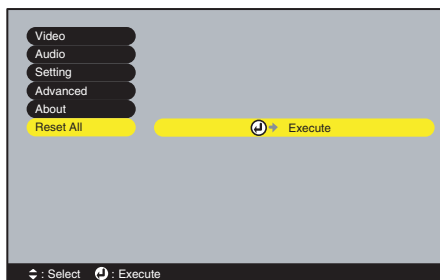

Sub-menu	Function	Default
Execute	Resets all items in all menus to their default settings. <ul style="list-style-type: none"> • Press the [Enter] button to display the confirmation screen, and select Yes. • Select Reset in an individual menu to reset only the settings for the items in each sub-menu. • The EPSON Cinema Filter, Input Signal, Video Signal, Lamp and Language settings will not return to their default settings. 	-

Using the Configuration Menus

The configuration menus can only be accessed using the remote control.

Procedure

1

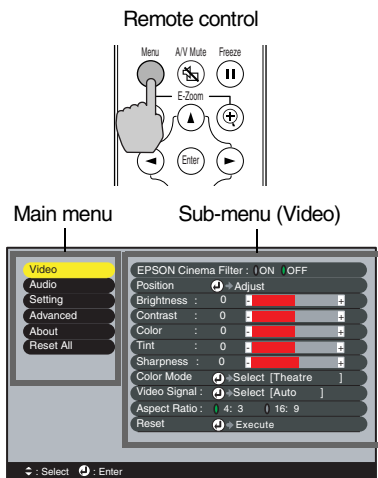

Press the [Menu] button on the remote control.

The configuration menu appears. The configuration menu consists of a main menu and sub-menus. The sub-menu that corresponds to the currently-selected item in the main menu (displayed in yellow) appears.

2

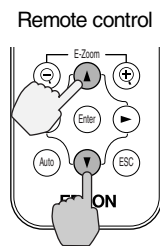

Select a menu item.

Press the [▲] or [▼] button to move to an item to be selected.

3

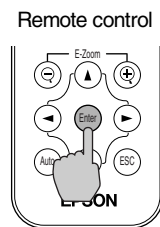

Confirm the selection.

Press the [Enter] button to confirm the selection of a menu item.

The sub-menu that corresponds to the currently-selected item in the main menu appears.

4

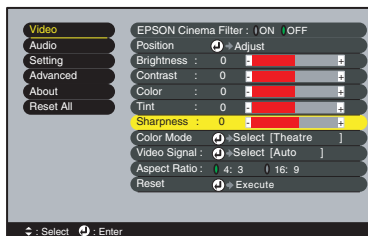

Select a sub-menu item.

Press the [▲] or [▼] button to move to an item to be selected.

The items appearing in the Video menu and the About menu will vary depending on the type of input source being projected.

5

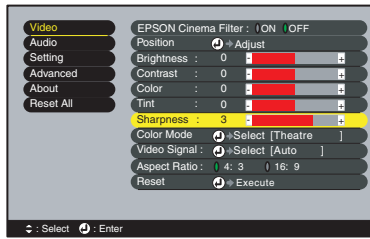

Select a setting value.

Press the [◀] and [▶] buttons to change the setting value.

For commands which have ON/OFF settings, use the [◀] and [▶] buttons to select the desired setting, and then press the [Enter] button.



- Sub-menu items that cause another sub-menu to be displayed have ⊕ after them. If you select these menu items and press the [Enter] button, you can then change the settings in the next sub-menu that appears.
- Refer to list of functions for details on the functions of each menu item. (p.22)

6

Select other menu items in the same way.

Repeat steps 2 to 5 to change the setting for other menu items. To return to a previous menu, press the [ESC] button.

7

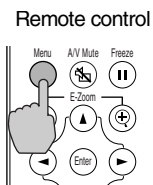

Close the menu.

Press the [Menu] button.

Useful Functions When a Computer Is Connected

This section describes the various functions that can be used to enhance presentations.

A/V Mute

This function momentarily pauses the image and sound.

For example, it can be used when you do not want to show viewers details of operations such as selecting different files while computer images are being projected.

However, if you use this function when projecting moving images, the images and sound will still continue to be played back by the source, and you cannot return to the point where the mute function was activated.

Procedure

Remote control

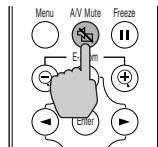

Press the [A/V Mute] button on the remote control.

The image and sound are paused.

Press the [A/V Mute] button again to continue normal projection.

Solid black



Default setting

Solid blue



When the images and sound are paused, one of the following types of display appears, depending on the A/V Mute setting in the Setting menu. (p.26)

Freeze

This function pauses only the projected images. The sound keeps playing without pausing.

The image source will continue to play back images while projection is paused, and it is not possible to resume projection from the point where it was paused.

Procedure

Remote control

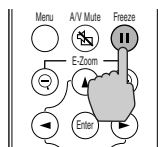

Press the [Freeze] button on the remote control.

The image is paused.

To continue projecting the image, press the [Freeze] button again or press the [ESC] button.



- Pressing the [Freeze] button also clears menu displays and help messages.
- The Freeze function still works while the E-Zoom function is being used. However, in this case the Freeze function can only be cancelled by pressing the [Freeze] button.

E-Zoom

This function lets you enlarge and reduce a part of a projected image such as a graph or table.

Procedure

1

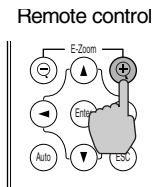

Press the [E-Zoom +] button on the remote control.

A cursor (cross) indicating the center point for the area to be enlarged will appear on the screen.

2

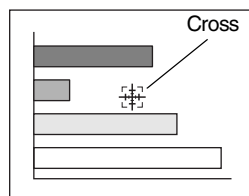

Move the cross to the area of the image that is to be enlarged or reduced.

Press the [▲], [▼], [◀] and [▶] buttons on the remote control to move the cross.

3

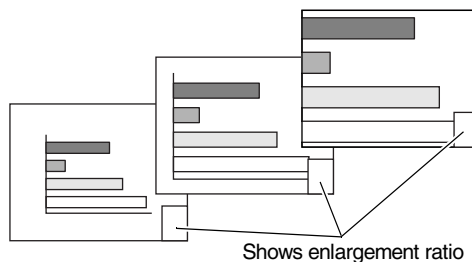

When [+] is pressed, the image is enlarged with the cross as its center. When [-] is pressed, the enlarged picture is then reduced.

The enlargement ratio will appear at the bottom right of the screen.

You can scroll around the image by pressing the [▲], [▼], [◀] and [▶] buttons.

To cancel the E-Zoom, press the [ESC] button.



The selected area can be enlarged to between 1– 4 times, in 25 steps of x0.125.

Troubleshooting

This section describes how to identify problems, and what to do if you find a problem.

Using the Help Function.....	34
When Having Trouble	35
(Warning) Indicator	35
Power Indicator	36
When the Indicators Provide No Help.....	37



Using the Help Function

If a problem occurs with the projector, use the Help function to assist you in solving the problem. It uses a series of menus in a question and answer format. The questions vary depending on the type of image source.

Procedure

1

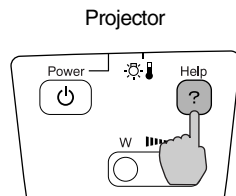

Press the [Help] button on the projector's control panel.

The help menu displays.

2

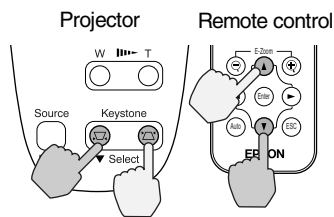

Select a menu item.

When using the control panel, the [▼ Select ▲] buttons function as the up and down keys.

When using the remote control, press the [▲] and [▼] buttons to select an item.

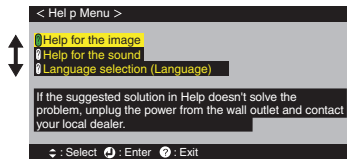

3

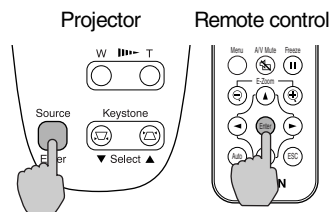

Confirm the selection.

Press the [Enter] button to confirm the selection of a menu item.

4

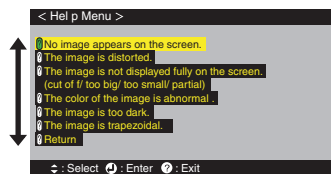

Repeat the operations in steps 2 and 3 to proceed through the menu to more detailed items.

You can exit the help menu at any time by pressing the [Help] button.



If the Help function does not provide a solution to the problem, refer to “When Having Trouble” (p.35) or “When the Indicators Provide No Help” (p.37).

When Having Trouble

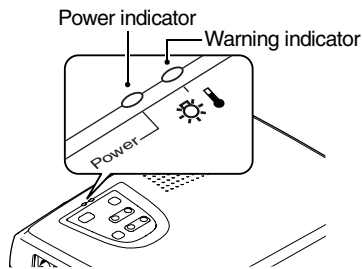

If you are having a problem with the projector, first check its indicators. The projector has the following two indicators to alert you to problems.



The following tables show what the indicators mean and how to remedy any problems they indicate.

(Warning) Indicator





● : lit  : flashing

Status	Cause	Remedy or Status	See Page
Red ●	High internal temperature (overheating)	The lamp turns off automatically and projection stops. Wait for about 5 minutes without operating the projector. After about 5 minutes, unplug the power cord and then check the following two things: <ul style="list-style-type: none"> • Check that the air inlet and air outlet are clear, and that the projector is not positioned against a wall. • If the air filter is dirty, clean it. When the power cord is plugged back in, the projector will return to its previous state, so press the [Power] button on either the projector's control panel or the remote control to turn it back on. If the projector continues to overheat even after the above things have been checked, or if the indicators show a problem when the power is turned back on, stop using the projector, disconnect the power cord from the electrical outlet, and contact your dealer or the nearest address provided in the <i>International Warranty Terms</i> brochure that came with the projector.	p.46
Red  (0.5-second intervals)	Problem with lamp	Disconnect the power cord from the electrical outlet and then remove the lamp to check if it is broken. If the lamp is not broken, reinstall it. Then reconnect the power cord and press the [Power] button on either the projector's control panel or on the remote control to turn the power back on. If the indicators still show a problem, stop using the projector, disconnect the power cord from the electrical outlet, and contact your dealer or the nearest address provided in the <i>International Warranty Terms</i> brochure that came with the projector.	p.48
		If the lamp is broken, replace it with a new lamp, or contact your local dealer for further advice. If replacing the lamp yourself, be careful to avoid pieces of broken glass. Projection is not possible until the lamp is replaced.	p.48
		Check that the lamp and the lamp cover are securely installed. If the lamp or lamp cover is not securely installed, the lamp cannot be powered on.	p.48
Red  (1-second intervals)	Internal problem	Stop using the projector, disconnect the power cord from the electrical outlet, and contact your dealer or the nearest address provided in the <i>International Warranty Terms</i> brochure that came with the projector.	

Status	Cause	Remedy or Status	See Page
Orange 	High-speed cooling in progress	(This is not an abnormality, but if the temperature rises too high again, projection will stop automatically.) <ul style="list-style-type: none"> •Set the projector up in a place which is well-ventilated, and make sure the air filter and exhaust vents are clear. •Clean the air filter. 	p.46

Power Indicator

 : lit  : flashing

Status	Cause	Remedy or Status	See Page
Orange 	Standby status	(Not abnormal) The power cord should only be disconnected when the projector is in this condition. Press the [Power] button to start projection.	p.8
Orange 	Cool-down in progress	(Not abnormal) <ul style="list-style-type: none"> •Please wait. The <u>cool-down</u> period lasts for about 25 seconds. •The [Power] button does not work during cool-down. Press the button again after cool-down ends. 	p.10
Green 	Projection in progress	(Not abnormal)	p.9
Green 	Warm-up in progress	(Not abnormal) Please wait. Warm-up time is approximately 40 seconds. After warm-up is complete, the flashing green indicator changes to steady green.	p.9



- If the projector is not operating properly even though the indicators are all showing normal status, refer to “When the Indicators Provide No Help” on the following page.
- If an indicator is showing a status that does not appear in the previous tables, contact your dealer or the nearest address provided in the *International Warranty Terms* brochure that came with the projector.

When the Indicators Provide No Help

If any of the following problems occur and the indicators do not offer a solution, refer to the pages given for each problem.

No images appear	p.37	Image appears dark	p.40
Poor image quality (out of focus or distorted)	p.38	Image appears greenish	p.41
Only part of the image is displayed (large/small)	p.39	Image appears purplish	
The image colors are not right	p.40	No sound can be heard	p.41
		The remote control does not work	p.42
		The power does not turn off	p.42

	Condition No image appears (nothing at all appears)
-----------------------------------------------------------------------------------	------------------------------------------------------------

Probable cause	Remedy
Was the power turned off and then immediately back on again? After the power is turned off (during cool-down), the [Power] buttons on the projector's control panel and the remote control will not work.	→ Wait until cool-down has finished. You can then use the [Power] button. (p.10)
Is sleep mode active? When sleep mode has been set to ON, the lamp turns off automatically if no operations are carried out for 30 minutes while no image signal is being input. The Power indicator lights orange at this time.	→ Turn the projector power back on. To cancel the sleep mode setting, set Sleep Mode to OFF. Setting - Sleep Mode (p.26)
Have you pressed the [Power] button?	→ Press the [Power] button on the projector's control panel or the remote control to turn on the power. (p.9)
Has the image brightness been adjusted correctly?	→ Use the Brightness command to adjust. Video - Brightness (p.22, 24)
Is A/V Mute mode active?	→ Press the [A/V Mute] button on the remote control to cancel A/V Mute mode. (p.31)
Is the projected image completely black? Some input images, such as screen savers, may be completely black.	→ Cancel the screen saver, or re-check the images being input.
Is an image signal being input? If No-Signal Msg. has been set to OFF, no messages will be displayed.	→ Change the No-Signal Msg. setting to Black or Blue for messages to be displayed. Setting - No-Signal Msg. (p.25) If a message is displayed, refer to the item indicated.
Try resetting all of the current settings.	→ Reset All - Execute (p.28)

	Condition No image appears (Messages do appear) “Not Supported.” is displayed. “No-Signal.” is displayed.
-------------------------------------------------------------------------------------	------------------------------------------------------------------------------------------------------------------------

Probable cause	Remedy
Are the cables connected correctly?	→ Check that all cables that are required for projection are connected correctly. (See <i>Quick Setup</i> poster)

Probable cause	Remedy
Does the input signal match the connected source?	→ Use the [Source] button on the projector's control panel (or the [Computer] or [S-Video/Video] button on the remote control) to select the correct signal source. (p.9)
Is the power for the video source or computer turned on?	→ Turn on the power. (p.9)
If a laptop computer or a computer with a LCD screen has been connected to the projector, it is necessary to output the image signals to the projector rather than to the screen.	→ Normally, image signals are output to only the computer's LCD screen, so you need to change the output to an external destination. For some computer models, when the image signals are output externally, they no longer appear on the LCD screen. For details, refer to the section of the documentation provided with your computer under a heading such as "External output" or "Connecting an external monitor." (p.9)
Check the mode that corresponds to the frequency of the image signals being output from the computer.	→ Refer to the documentation provided with your computer for details on changing the resolution and frequency of the image signals being output from the computer. (p.53)

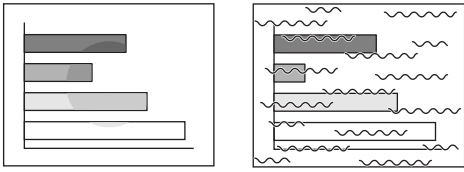
	<p>Condition</p> <p>Poor image quality (out of focus or distorted)</p> <ul style="list-style-type: none"> • The image is fuzzy • Part of the image is out of focus • The whole image is out of focus • Image is distorted • Image contains interference
------------------------------------------------------------------------------------	--------------------------------------------------------------------------------------------------------------------------------------------------------------------------------------------------------------------------------------------------------------------------------------------------------------------------

Probable cause	Remedy
Has the focus been adjusted correctly?	→ Adjust the focus. (p.12)
Is the lens cover still attached?	→ Remove the lens cover. (p.8)
Have the front feet been adjusted so that the image angle is too extreme? If the image angle is too extreme, the image will be out of focus vertically.	→ Adjust the front feet to reduce the angle of tilt to 10° or less. (p.13)
Is the projector at the correct distance?	→ The recommended distance from the projector to the screen is within 0.9–11.3 m (2.9–37.0 ft.). Set up the projector so that the projection distance is within this range. (See <i>Quick Setup</i> poster)
Is the projector beam perpendicular to the screen?	→ Adjust the projection angle so that the projector beam is perpendicular to the screen. (p.13)
Is the lens dirty?	→ Clean the lens. (p.46)
Has condensation formed on the lens? If the projector is suddenly taken from a cold environment to a warm environment, condensation may form on the surface of the lens, and this may cause the image to appear fuzzy.	→ Set the projector up in the room approximately one hour before it is to be used. If condensation forms on the lens, turn off the power and wait for the condensation to disappear.
Is the EPSON cinema filter attached correctly? If it is not attached correctly, the images may appear uneven or out of focus.	→ Remove the cinema filter and reattach it. (p.15)

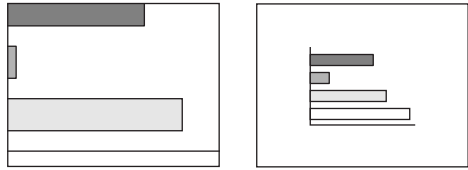

Probable cause	Remedy
Are the image signal format settings correct?	→ If a <u>component video</u> ▶▶, RGB video or computer source is connected to the projector, use the Input Signal command to select the signal format that matches the signal connected source. Video - Input Signal (p.23, 24) If a <u>composite video</u> ▶▶ or <u>S-Video</u> ▶▶ source is connected to the projector, use the Video Signal command to select the video signal format. Video - Video Signal (p.23)
Are both Video and S-Video ports connected?	→ Turn off the power for the video source that is not being projected.
Are the cables connected correctly?	→ Check that all cables that are required for projection are connected correctly. (See <i>Quick Setup</i> poster)
Is an extension cable being used? If an extension cable is used, electrical interference may affect the signals.	→ Use the cable that came with the projector and see if this helps.
Have <u>Sync.</u> ▶▶, <u>Tracking</u> ▶▶ and Position been adjusted correctly? (when connected to a computer)	→ If the Auto Setup command in the Video menu is set to OFF, press the [Auto] button on the remote control to adjust these settings. If the images have not been correctly adjusted after using the automatic setup function and after pressing the [Auto] button, adjust the settings manually using the respective menus. (p.17, 24)
Has the correct resolution been selected? (when connected to a computer)	→ Set the computer so that the signals that are output are compatible with the projector. Refer to the documentation provided with your computer for details on changing the settings. (p.53)

	<p>Condition</p> <ul style="list-style-type: none"> • Image is too large (only part of the image is displayed) • Image is too small
-------------------------------------------------------------------------------------	--------------------------------------------------------------------------------------------------------------------------------------------------------------------

Probable cause	Remedy
Is the [Zoom] button setting correct?	→ Use the [Zoom] button to adjust the size of the image. (p.12)
Has the <u>Aspect Ratio</u> ▶▶ setting been selected correctly?	→ Use the Aspect Ratio command to set the aspect ratio to 4:3. Video - Aspect Ratio (p.23)
Is the E-Zoom function being used to enlarge the image?	→ Press the [ESC] button on the remote control to cancel E-Zoom. (p.32)
Has the Position setting been adjusted correctly?	→ Use the Position command to adjust. Video - Position (p.22, 24)
Has the correct resolution been selected? (when connected to a computer)	→ Set the computer so that the signals that are output are compatible with this projector. Refer to the documentation provided with your computer for details on changing the settings. (p.53)
Change the resolution for the laptop computer or computer with an LCD screen. (when connected to a computer)	→ Change the resolution so that the image is displayed in the whole of the projection area, or set the image signal to external output only. (p.9)

Probable cause	Remedy
Has the computer been set for dual display? (when connected to a computer)	➔ If dual display has been activated in the Display Properties of the connected computer's Control Panel, the projector will display only about half of the image on the computer screen. To display the whole image, turn off dual display. Refer to the video driver manual or to the computer's monitor manual for further details.

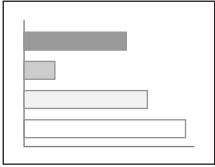
	<p>Condition</p> <p>The image colors are not right</p>
-----------------------------------------------------------------------------------	--------------------------------------------------------

Probable cause	Remedy
Has the image brightness been adjusted correctly?	➔ Use the Brightness command to adjust. Video - Brightness (p.22, 24)
Are the cables connected correctly?	➔ Check that all cables that are required for projection are connected correctly. (See <i>Quick Setup</i> poster)
Are the image signal format settings correct? If the Input Signal menu command is set to YCbCr or YPbPr when a computer is connected, the projected images will appear purplish. If the Input Signal command is set to RGB when a component video signal source is connected to the projector, the images will appear greenish.	➔ If a <u>component video</u> source is connected to the projector, use the Input Signal command to select the signal format which matches the signal connected source. Video - Input Signal (p.23, 24) If a <u>composite video</u> or <u>S-Video</u> source is connected to the projector, use the Video Signal command to select the video signal format. Video - Video Signal (p.23)
Has the image <u>contrast</u> been adjusted correctly?	➔ Use the Contrast command to adjust. Video - Contrast (p.22, 24)
Has the color been adjusted correctly?	➔ Use the Color Adjustment command to adjust the contrast. Advanced - Color Adjustment (p.26)
Have the color intensity and tint been adjusted correctly? (The colors may not exactly match the colors in the image on the computer screen or LCD screen, but this is normal and not a sign of a problem.)	➔ Use the Video menu to adjust the Color and Tint settings. Video - Color, Tint (p.22, 23)
Is the lamp due for replacement? When the lamp is nearly due for replacement, the image will become darker and the color quality will become poorer.	➔ When this happens, the lamp should be replaced with a new one. (p.48)
The cinema filter has been removed from the lens, but the EPSON Cinema Filter command in the Video menu is still set to ON.	➔ Change the EPSON Cinema Filter setting in the Video menu to OFF. Video - EPSON Cinema Filter (p.22, 24)

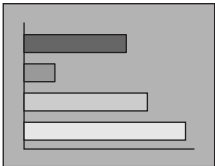
	<p>Condition</p> <p>Images appear dark</p>
-------------------------------------------------------------------------------------	--------------------------------------------

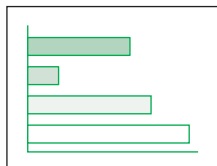

Probable cause	Remedy
Is the lamp due for replacement? When the lamp is nearly due for replacement, the image will become darker and the color quality will become poorer.	→ When this happens, the lamp should be replaced with a new one. (p.48)
Has the image brightness been adjusted correctly?	→ Use the Brightness command to adjust. Video - Brightness (p.22, 24)
Is the EPSON cinema filter still attached to the projector's lens?	→ If connecting a computer to the projector to give presentations, remove the cinema filter and set the EPSON Cinema Filter command to OFF. Video - EPSON Cinema Filter (p.22, 24)
Has the image <u>contrast</u> been adjusted correctly?	→ Use the Contrast command to adjust. Video - Contrast (p.22, 24)

	<p>Condition</p> <p>Images appear greenish Images appear purplish</p>
-----------------------------------------------------------------------------------	---------------------------------------------------------------------------

Probable cause	Remedy
Are the image signal format settings correct? If the Input Signal menu command is set to YCbCr or YPbPr when a computer is connected, the projected images will appear purplish. If the Input Signal command is set to RGB when a component video signal source is connected to the projector, the images will appear greenish.	→ If a <u>component video</u> , RGB video or computer source is connected to the projector, use the Input Signal command to select the signal format which matches the signal connected source. Video - Input Signal (p.23, 24) If a <u>composite video</u> or <u>S-Video</u> source is connected to the projector, use the Video Signal command to select the video signal format. Video - Video Signal (p.23)

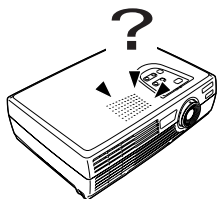
	<p>Condition</p> <p>No sound can be heard.</p>
-------------------------------------------------------------------------------------	------------------------------------------------

Probable cause	Remedy
Is the audio source connected correctly?	→ Check that the cable being used matches the input port. (See <i>Quick Setup</i> poster)
Has the correct audio input port been selected?	→ Use the Audio Input menu command to select the port to use for audio input. Audio - Audio Input (p.25)
Is sound being output from the audio source?	→ Check the volume for the audio source.
Has the volume been adjusted to the minimum setting?	→ Adjust the volume so that the sound is audible. Audio - Volume (p.25)
Is A/V Mute mode active?	→ Press the [A/V Mute] button on the remote control to cancel A/V Mute mode. (p.31)

	<p>Condition</p> <p>The remote control does not work</p>
-----------------------------------------------------------------------------------	----------------------------------------------------------

Probable cause	Remedy
Is the remote control light-emitting area facing towards the remote control light-receiving area when it is operated?	→ The operating angle for the remote control is approximately $\pm 30^\circ$ horizontally and approximately $\pm 15^\circ$ vertically. Use the remote control within these ranges. (See <i>Quick Setup</i> poster)
Is the remote control too far from the projector?	→ The operating distance for the remote control is approximately 6 m (20 ft.). Use the remote control within this distance. (See <i>Quick Setup</i> poster)
Is direct sunlight or strong light from fluorescent lamps shining onto the remote control light-receiving area?	→ Avoid using the projector in places where the remote control light-receiving area is exposed to strong light.
Has the battery insulating tape been removed?	→ When using the remote control for the first time, pull out the insulating tape that is protruding from the battery holder. (See <i>Quick Setup</i> poster)
Is the battery inserted?	→ Insert the battery. (p.47)
Is the battery depleted?	→ Replace the battery with a new one. (p.47)
Is the battery inserted incorrectly?	→ Reinsert the battery so it is installed correctly. (p.47)

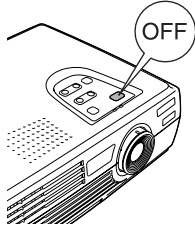
	<p>Condition</p> <p>The power does not turn off (after the [Power] button is pressed)</p>
-------------------------------------------------------------------------------------	-------------------------------------------------------------------------------------------

Probable cause	Remedy
The Power indicator remains orange. This projector is designed so that the Power indicator remains lit even after the power has been turned off.	→ The Power indicator will switch off when the power cord is disconnected from the electrical outlet.
The cooling fan does not stop. After you press the [Power] button to turn off the power, the <u>cool-down</u> period starts.	→ After the cool-down period, the Power indicator changes to a steady orange, and you can then disconnect the power cord from the electrical outlet. * The cool-down period lasts for about 25 seconds. The actual time will vary depending on the external air temperature.

Appendix

This appendix provides information on safety, and maintenance procedures to ensure the best level of performance for the projector.

Important Safety Instructions	44
Maintenance	46
Cleaning	46
Cleaning the Projector Case	46
Cleaning the Lens and EPSON Cinema Filter	46
Cleaning the Air Filter.....	46
Replacing Consumables.....	47
Inserting the Battery	47
Lamp Replacement Period.....	48
Replacing the Lamp	48
Resetting the Lamp Operating Time	50
Replacing the Air Filter.....	51
Optional Accessories	52
List of Supported Monitors	53
Component Video Input/RGB Video Input	53
Composite Video/S-Video Input.....	53
Computer	53
Specifications.....	54
Safety.....	55
Appearance	56
Part Names and Functions.....	57
Front/Top.....	57
Control Panel.....	58
Left Side	58
Rear	59
Base.....	59
Remote Control	60
Glossary.....	61
Index.....	63

Important Safety Instructions

Follow these safety instructions when setting up and using the projector:

- Do not place the projector on an unstable cart, stand, or table.
- Do not use the projector near water or sources of heat.
- Use the type of power source indicated on the projector. If you are not sure of the power available, consult your dealer or power company.
- Place the projector near a wall outlet where the plug can be easily unplugged.
Placez l'appareil près d'une prise de courant où la fiche peut être débranchée facilement.
- Insert the projector's three-wire grounding-type plug into a properly grounded outlet. If you have a two-prong outlet, contact an electrician to replace it. Do not hold the plug with wet hands.
- Take the following precautions for the plug. Failure to comply with these precautions could result in sparks or fire: Do not insert the plug into an outlet with dust present. Insert the plug firmly into the outlet.
- Do not overload wall outlets, extension cords, or integral convenience receptacles. This can cause fire or electric shock.
- Do not place the projector where the cord can be walked on. This may result in fraying or damage to the plug.
- Unplug the projector from the wall outlet before cleaning. Use a damp cloth for cleaning. Do not use liquid or aerosol cleaners.
- Do not block the slots and openings in the projector case. They provide ventilation and prevent the projector from overheating. Do not operate the projector on a sofa, rug, or other soft surface, or in a closed-in cabinet unless proper ventilation is provided.
- Never push objects of any kind through the cabinet slots. Never spill liquid of any kind into the projector.
- Except as specifically explained in this *User's Guide*, do not attempt to service this product yourself. Refer all servicing to qualified personnel. Opening or removing covers may expose you to dangerous voltages and other hazards.
- Unplug the projector from the wall outlet and refer servicing to qualified service personnel under the following conditions: When the power cord or plug is damaged or frayed. If liquid has been spilled into the projector, or if it has been exposed to rain or water. If it does not operate normally when you follow the operating instructions, or if it exhibits a distinct change in performance, indicating a need for service. If it has been dropped or the housing has been damaged.
- Unplug the projector during lightning storms or when it will not be used for extended periods.
- Do not place the projector and/or remote control on top of heat-producing equipment or in a hot location.
- If you use the projector in a country other than where you purchased it, use the correct power cord for that country.
- Do not stand on the projector or place heavy objects on it.
- Do not use the projector outside of the required temperature range of 41 to 95 °F (5 to 35 °C). Doing so may cause an unstable display and could lead to projector damage.
- Do not store the projector outside of the required temperature range of 14 to 140 °F (-10 to 60 °C) or in direct sunlight for long periods of time. Doing so may cause damage to the case.
- The projector contains many glass parts such as the lens and projection lamp. The lamp is fragile and can easily break. If the lamp breaks, handle the projector very carefully to avoid injury from broken glass, and contact your dealer or service representative for repair. Be careful to avoid getting pieces of glass in the eyes or mouth.
- Be particularly careful if the projector is installed against the ceiling, as small pieces of glass may fall down when the lamp cover is removed.
- Never try to remove the lamp immediately after use, as this will cause serious burns. See page 48 for instructions on replacing the lamp.

- 
- A mercury lamp with high internal pressure is used as the projector's light source. Mercury lamps may make a loud noise when they break. To avoid injury or poisoning, handle the lamp with extreme care while observing the following:
 - Do not damage the lamp or subject it to any impacts.
 - Do not use the lamp after the lamp replacement period has elapsed, as the possibility of breaking the lamp increases. Replace the lamp with a new one as soon as possible after receiving the lamp replacement message.
 - The gases inside mercury lamps contain mercury vapor which is released when the lamps break. If the lamp breaks, immediately ventilate the room to prevent the gases from being inhaled or coming into contact with the eyes or mouth.
 - Do not bring your face close to the projector while it is in use.
 - If the lamp breaks and gas from the lamp or fragments of broken glass are inhaled or get into the eyes or mouth, or if any other ill effects are noticed, immediately seek medical attention.

Maintenance

This section describes maintenance tasks such as cleaning the projector and replacing consumable parts.

Cleaning

You should clean the projector if it becomes dirty or if the quality of the projected image starts to deteriorate.



Be sure to read *Important Safety Instructions* in this chapter before cleaning.

Cleaning the Projector Case

Clean the projector case by wiping it gently with a soft cloth.

If the projector is particularly dirty, moisten the cloth with water containing a small amount of neutral detergent, and then firmly wring the cloth dry before using it to wipe the projector case. Then wipe the case again with a soft, dry cloth.



Do not use volatile substances such as wax, alcohol or thinner to clean the projector case. These can cause the case to warp and make the finish peel off.

Cleaning the Lens and EPSON Cinema Filter

Use a commercially-available low-velocity air blower, or use lens cleaning paper to gently wipe the lens and the cinema filter.



Do not rub the lens or the EPSON cinema filter with harsh materials or subject them to shocks, as they can easily become damaged.

Cleaning the Air Filter

If the air filter becomes clogged with dust, it can cause overheating and damage the projector.

Turn the projector upside down and use a vacuum cleaner to remove the dust from the air filter.

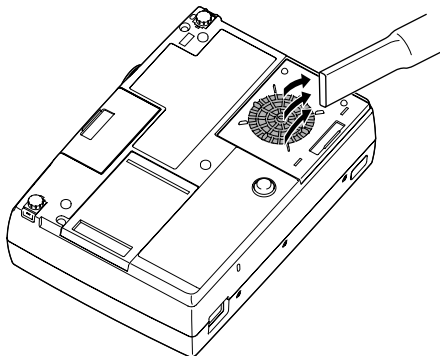

- If the air filter is difficult to clean or broken, you should replace it. Contact your dealer for a new air filter.
- The air filter should be replaced when the lamp is replaced.

Replacing Consumables

This section describes how to replace the lamp, the air filter and the battery in the remote control.

Inserting the Battery

Use the following type of battery as a replacement.

1 CR2025 lithium battery



Be sure to read *Important Safety Instructions* in this chapter before handling the battery.

Procedure

1

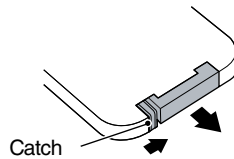

Remove the battery holder.

While pushing the catch of the battery holder inward, pull the battery holder out.

2

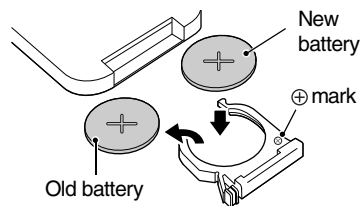

Remove the old battery and insert the new battery.

Check the position of the (+) mark inside the battery holder to ensure that the battery is inserted the correct way.

3

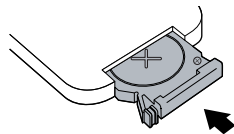

Insert the battery holder into the remote control.

Push the battery holder in until it clicks.



Dispose of used batteries in accordance with local regulations.

Lamp Replacement Period

It is time to replace the lamp when:

- The message “Lamp Replace” appears on the screen when projection starts.



The message appears for 30 seconds, and disappears again after 30 seconds.

A message is displayed.

- When the  (Warning) indicator is flashing red at 0.5-second intervals.

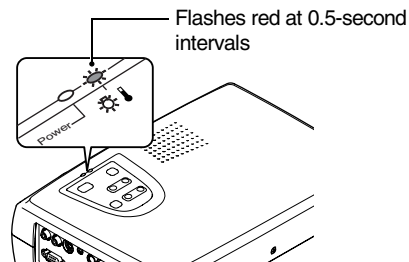

- The projected image gets darker or starts to deteriorate.



- The replacement warning message appears after about 1400 hours of lamp use in order to maintain the brightness and quality of the projected image. If you continue to use the lamp after this point, the possibility of the lamp breaking becomes greater. When the lamp replacement message appears, replace the lamp with a new one as soon as possible, even if it is still working.
- The warning message appears after about 1400 hours of use, but the actual life of each individual lamp varies depending on the characteristics of the lamp and on the way it has been used. Some lamps may stop operating before 1400 hours of use, so you should always have a spare lamp ready.
- Contact your dealer to purchase a spare lamp.

Replacing the Lamp



- If the lamp stops working and needs to be replaced, there is the danger that the lamp may break when handled. If you replace the lamp of a projector that has been installed on the ceiling, you should always assume that the lamp is broken and remove the lamp cover very carefully.
- Wait until the lamp has cooled down sufficiently before opening the lamp cover. It takes an hour after the cool-down  period has finished for the lamp to be cool enough to handle.

Procedure

1

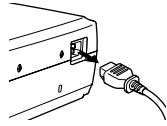

Turn off the projector power, wait for the cool-down period to end, and then disconnect the power cord.

The cool-down period lasts for about 25 seconds. The actual time will vary depending on the external air temperature.

2

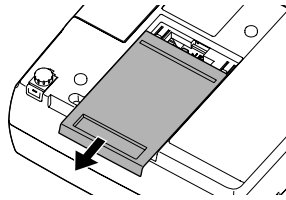

Wait until the lamp has cooled down, and then remove the lamp cover from the base of the projector.

It takes approximately one hour for the lamp to cool down by itself after the cool-down period has finished.

Put your finger into the recess, and then pull straight out to remove the lamp cover.

3

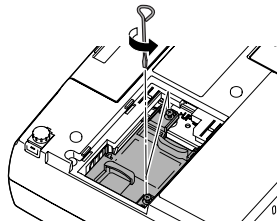

Loosen the two lamp fixing screws.

Use the screwdriver that is supplied with the spare lamp or a Phillips screwdriver to loosen the two lamp fixing screws that secure the lamp to the projector.

4

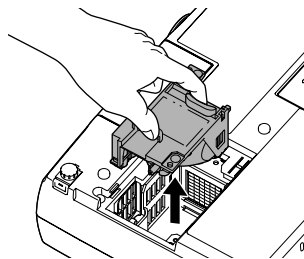

Take out the lamp.

Hold the lamp by the two tabs to lift it up and out from the projector.

If the lamp is broken, replace it with a new lamp, or contact your local dealer for further advice.

If replacing the lamp yourself, be careful to avoid pieces of broken glass.

(Projection cannot be carried out until the lamp is replaced.)

5

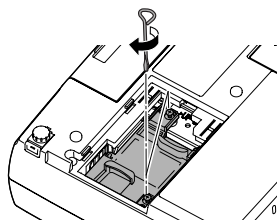

Install the new lamp.

Hold the lamp so that it faces the correct way to fit into the projector, and then insert the lamp and tighten the two lamp fixing screws.

6

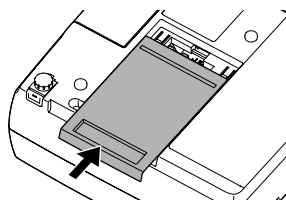

Install the lamp cover.

Slide the cover in from the outside, and then push it in until it clicks into place.

- 
 • Install the lamp securely. If the lamp cover is removed, the lamp turns off automatically as a safety precaution. Also, the lamp will not turn on if the lamp or the lamp cover is not installed correctly.
- The air filter should also be replaced when the lamp is replaced. (p.51)
- Dispose of used lamps properly in accordance with local regulations.

Resetting the Lamp Operating Time

The projector has a built-in counter that keeps track of the lamp operating time. When the cumulative operating time reaches a certain point, it causes the replacement warning message to display. Therefore, the counter needs to be reset after the lamp has been replaced with a new one. You can do this using the configuration menu.

- 
 Do not reset the lamp operating time except after the lamp has been replaced, otherwise the lamp replacement period will not be indicated correctly.

Procedure

- 1**

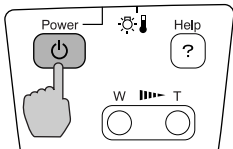

Projector

Connect the power cord, and then press the [Power] button on the projector's control panel or the remote control.
- 2**

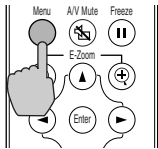

Remote control

Press the [Menu] button on the remote control. The configuration menu displays.
- 3**

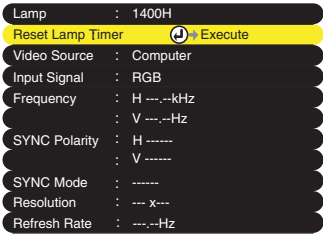

Lamp : 1400H
Reset Lamp Timer  Execute
 Video Source : Computer
 Input Signal : RGB
 Frequency : H ---,---kHz
 : V ---,---Hz
 SYNC Polarity : H -----
 : V -----
 SYNC Mode : -----
 Resolution : --- x---
 Refresh Rate : ---,---Hz

Select Reset Lamp Timer from the About menu and then press the [Enter] button.
- 4**

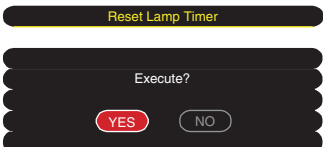

Reset Lamp Timer
 Execute?

Select Yes and then press the [Enter] button. The lamp operating time is reset.

Replacing the Air Filter

Procedure

1

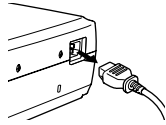

Turn off the projector power, wait for the **cool-down** period to end, and then **disconnect the power cord**.

The cool-down period lasts for about 25 seconds. The actual time varies depending on the external air temperature.

2

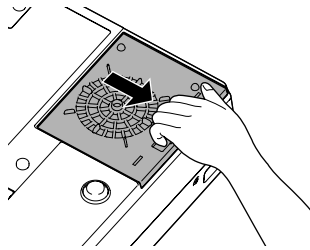

Put your finger into the recess, and then pull straight out to remove the air filter.

3

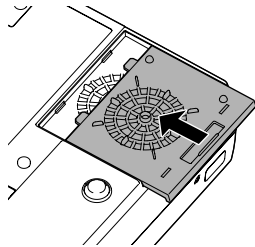

Install the new air filter.

Slide the cover in from the outside, and then push it in until it clicks into place.



Dispose of used air filters properly in accordance with your local regulations.

Optional Accessories

EPSON provides the following optional accessories for the projector. This list of optional accessories is current as of August 2002. Details of accessories are subject to change without notice.

Product	Product number
Replacement lamp	V13H010L19
Customized carrying cases: Samsonite® wheeled soft case ATA molded hard shell case Samsonite notebook/projector soft shoulder bag	ELPKS24 ELPKS44 ELPKS43
Ceiling mount Suspension adapter False ceiling plate	ELPMB38 ELPMBAPL ELPMBFCP
Mac adapter set	ELPAP01
Presentation Audio System Wireless microphone system High resolution document imager High resolution document camera Motion presentation camera	ELPPAS1 ELPCVSII ELPDC02 V12H064020 ELPDC03
Kensington security lock	ELPSL01
Projection screens: 50-inch portable projection screen 60-inch portable pop-up screen 80-inch portable pop-up screen	ELPSC06 ELPSC07 ELPSC08
Distribution amplifier	ELPDA01
Component video cable (VGA to component video)	ELPKC19

List of Supported Monitors

Component Video Input/RGB Video Input

Signal	Refresh rate▶▶ (Hz)	Aspect ratio▶▶ 4:3 Resolutions(dots)	Aspect ratio 16:9 Resolutions(dots)
<u>SDTV▶▶</u> (525i) (D1)	60	800 × 600	800 × 450
SDTV (625i)	50	800 × 600	800 × 450
SDTV (525p) (D2)		800 × 600	800 × 450
<u>HDTV▶▶</u> (750p) 16:9 (D4)		800 × 600	800 × 450
HDTV(1125i) 16:9 (D3)		800 × 600	800 × 450

Composite Video/S-Video Input

Signal	Refresh rate▶▶ (Hz)	Aspect ratio▶▶ 4:3 Resolutions(dots)	Aspect ratio 16:9 Resolutions(dots)
TV (NTSC)		800 × 600	800 × 450
TV (PAL, SECAM)		800 × 600	800 × 450

Computer

Signal	Refresh rate▶▶ (Hz)	Resolution (dots)	Resolutions for resized display▶▶ (dots)
PC98		640×400	800×500
EGA		640×350	800×438
<u>VGA▶▶</u>	60	640×480	800×600
VGACGA		640×400	800×500
VGAEGA		640×350	800×438
VGA text		720×400	800×444
		720×350	800×388
VESA	60/72/75/85,iMac*	640×480	800×600
<u>SVGA▶▶</u>	56/60/72/75/85,iMac*	800×600	800×600
<u>XGA▶▶</u>	43i/60/70/75/85,iMac*	1024×768	800×600
MAC13"		640×480	800×600
MAC16"		832×624	800×600
MAC19"		1024×768	800×600
MAC21"		1152×870	800×600
NTSC		640×480	800×600
PAL/SECAM		720×540	800×600
<u>HDTV▶▶</u> (525i)			800×600
HDTV(525p)			800×600
HDTV(750p)	60	1280×720	800×450
HDTV(1125i)	60	1920×1080	800×450

* Connection is not possible if the equipment does not have a VGA output port.

It may be possible to project signals that are not listed in the above table. However, not all functions may be supportable with such signals.

Specifications

Product name	PowerLite 30c Projector		
Dimensions	309 (W) x 93 (H) x 219 (D) mm (12.2 (W) x 3.7 (H) x 8.6 (D) in.) (not including feet and lens)		
Panel size	0.5 in.		
Display method	Polysilicon TFT active matrix		
Drive method	Full-line 6-phase block sequential writing		
Resolution	SVGA▶▶ 480,000 pixels (800 (W) x 600 (H) dots) x 3		
Focus adjustment	Manual		
Zoom adjustment	Electronic (approx. 1:1.2)		
Lamp (light source)	UHE lamp, 130 W, Model No.: ELPLP19		
Max. audio output	1W monaural		
Speaker	1		
Power supply	100–120 V AC, 2.2A 200–240 V AC, 1.0A 50/60 Hz		
Operating temperature	+5°–+35°C (41°–95°F) (No condensation)		
Storage temperature	-10°–+60°C (14°–140°F) (No condensation)		
Weight	Approx. 2.9 kg (6.4 lbs)		
Connectors	Computer/Component Video	1	Mini D-Sub 15-pin (female) Blue
	Monitor Out	1	Mini D-Sub 15-pin (female) Black
	Audio	1	Stereo mini jack
	Video	1	RCA pin jack
	S-Video	1	Mini DIN 4-pin
	Audio	1	RCA pin jack
	Control (RS-232C)	1	D-Sub 9-pin (male)

Safety

USA

UL1950 3rd Edition

Canada

CSA C22.2 No.950-95 (cUL)

European Community

The Low Voltage Directive (73/23/EEC)

IEC60950 2nd Edition, +Amd.1, +Amd.2, +Amd.3, +Amd.4

EMC

USA

FCC 47CFR Part15B Class B (DoC)

Canada

ICES-003 Class B

European Community

The EMC Directive (89/336/EEC)

EN55022, 1998 Class B

EN55024, 1998

IEC61000-4-2, IEC61000-4-3, IEC61000-4-4, IEC61000-4-5,

IEC61000-4-6, IEC61000-4-8, IEC61000-4-11,

IEC61000-3-2, IEC61000-3-3

Australia/New Zealand

AS/NZS 3548:1995, A1:1997, A2:1997 Class B

CISPR Pub.22:1993, A1:1995, A2:1996, Class B

Appearance

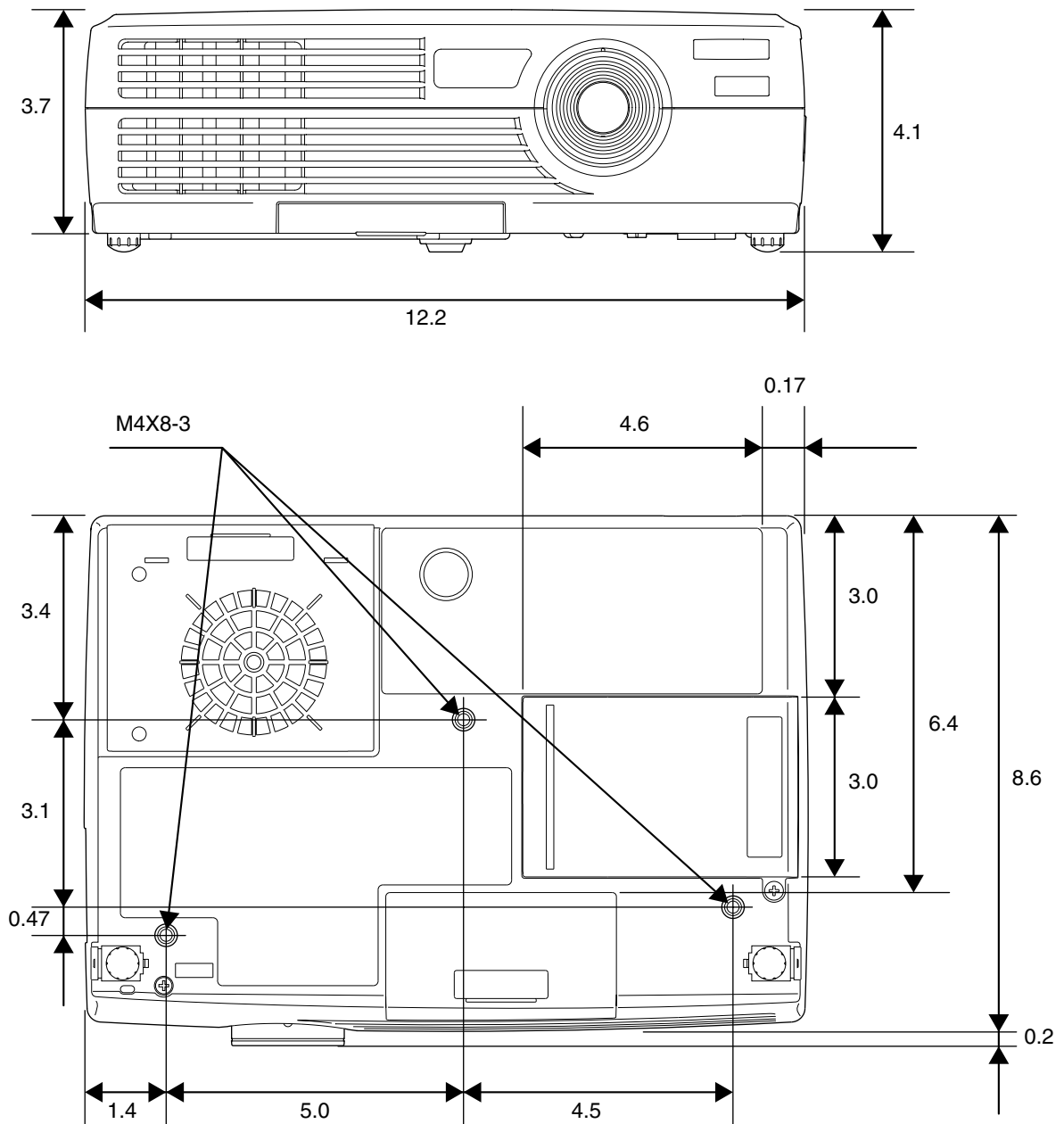

Units: inches

Part Names and Functions

Front/Top

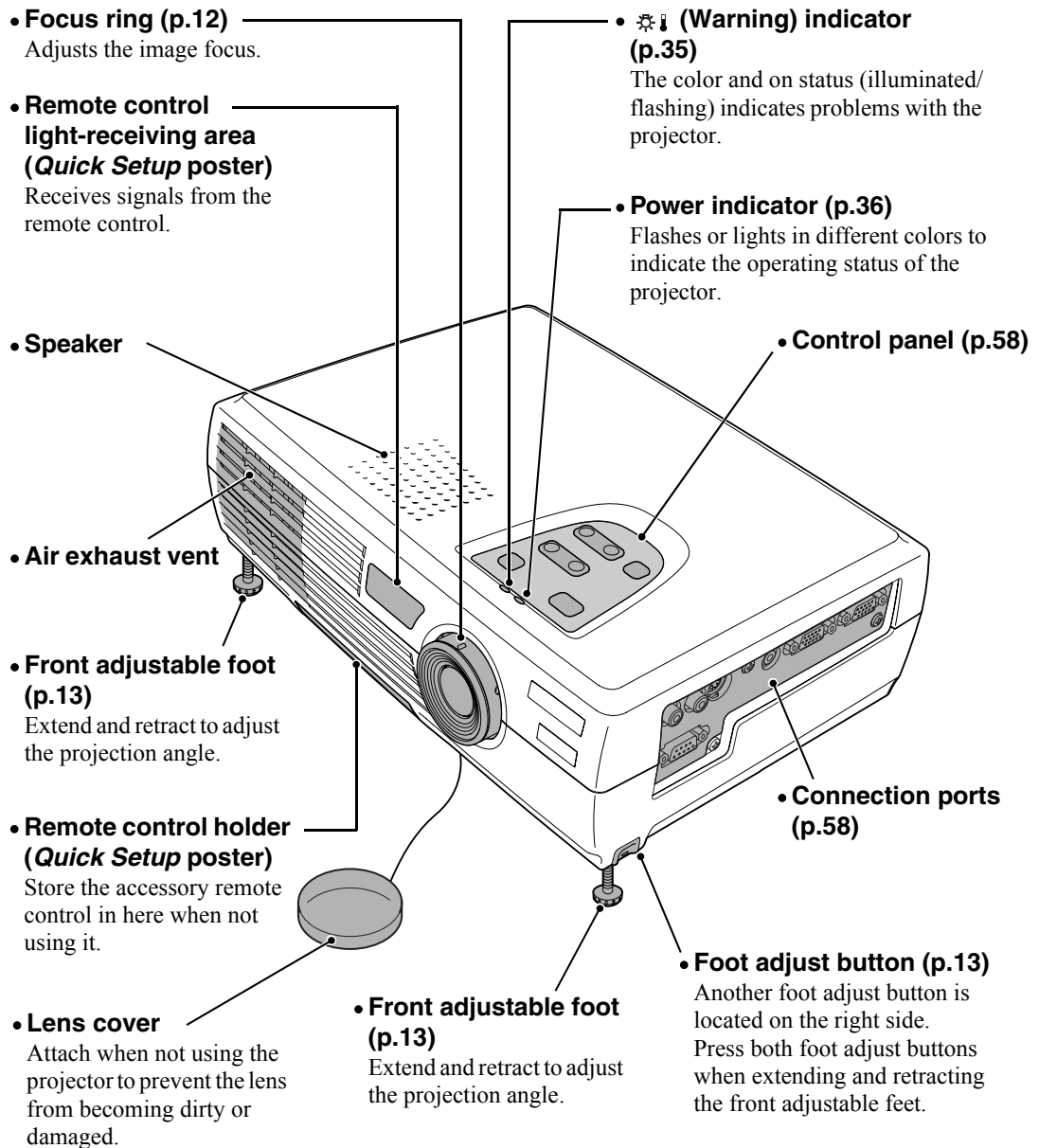

Control Panel

- **[Power] button (p.9, 10)**
Turns the projector power on and off.
- **[Help] button (p.34)**
Displays the online help menu.
- **[Source] button (p.9)**
Switches the input source between the Computer/Component Video port, S-Video port and Video port each time the button is pressed.
When pressed while a help menu is displayed, it accepts the menu item that is currently selected. (p.34)
- **[Zoom] button (p.12)**
Press to adjust the size of the projected images.
When pressed to the W side, the image becomes larger.
When pressed to the T side, the image becomes smaller.
- **[Keystone] button (p.14)**
Press to correct keystone distortion in the image.
When pressed while a help menu is displayed, it selects items in the menu. (p.34)

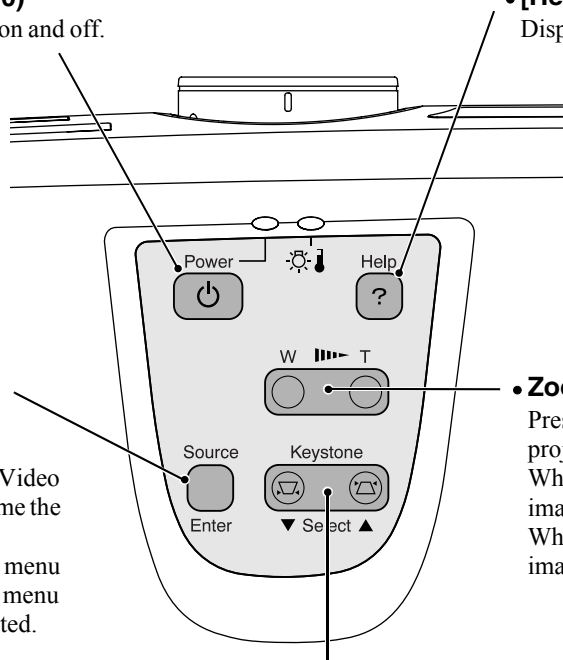

Left Side

- **S-Video port (Quick Setup poster)**
Inputs S-Video signals to the projector from other video sources.
- **Video port (Quick Setup poster)**
Inputs composite video signals to the projector from other video sources.
Use the RCA video cable for this connection.
- **Audio port (Quick Setup poster)**
Inputs audio signals from a video source.
Connect using an RCA audio cable.
- **Audio port (Quick Setup poster)**
Inputs audio signals from a component video or computer equipment.
Connect using a stereo mini jack.
- **Computer/Component Video port (Quick Setup poster)**
Inputs analog signals from a computer and component video signals from other video sources.
The connection surface is colored blue.
- **Control (RS-232C) port**
Connects the projector to a computer using an RS-232C cable.
This port is for service use and should not be used by the customer.
- **Monitor Out port (Quick Setup poster)**
Outputs the projected analog video signal from a computer to an external monitor. This feature is not available for video equipment signals.
The connection surface is colored black.

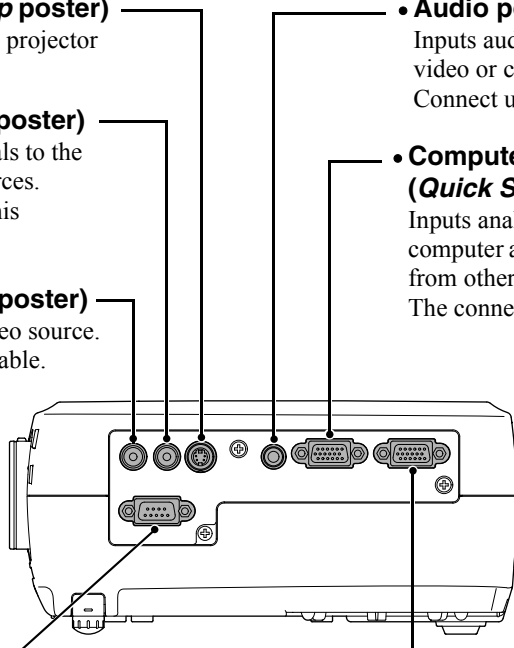

Rear

- **Remote control light-receiving area (Quick Setup poster)**

Receives signals from the remote control.

- **Power inlet (p.8)**

Connects the power cord.

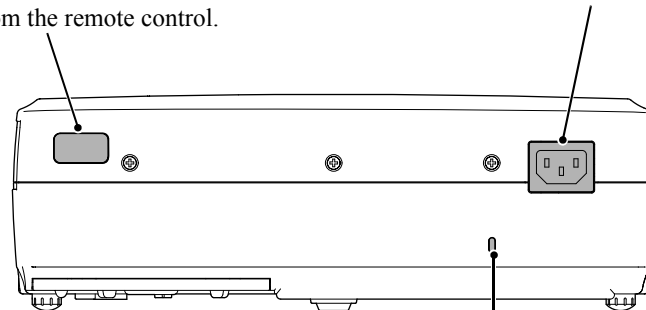

- **Security lock (p.61)**

Base

- **Fixing screw holes**

These holes are for the fixing screws that are used to secure the projector to items such as the ELPMB38 ceiling mount.

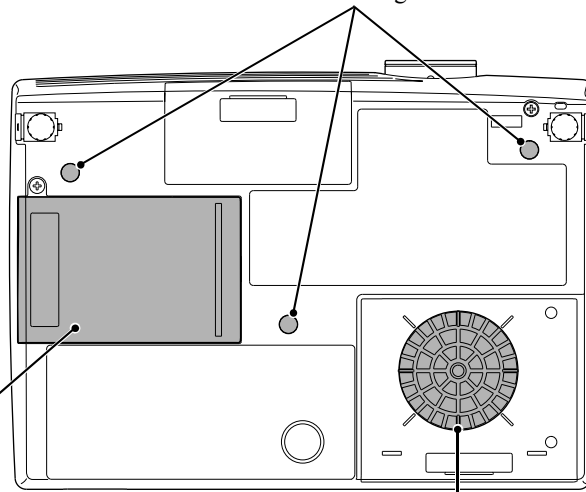

- **Lamp cover (p.48)**

Open this cover when replacing the lamp.

- **Air filter (air intake vent) (p.46, 51)**

Prevents dust and other foreign particles from being drawn into the projector. When replacing the lamp, replace the air filter also.

Remote Control

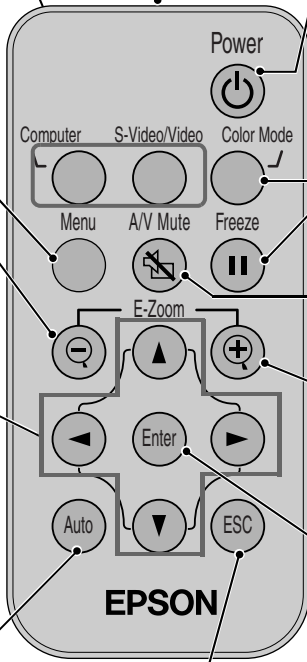
- 
- The diagram shows a grey remote control with the 'EPSON' logo at the bottom. It features a 'Power' button at the top right, a 'Remote control light-emitting area' at the top center, and several rows of buttons including 'Computer', 'S-Video/Video', 'Color Mode', 'Menu', 'A/V Mute', 'Freeze', 'E-Zoom', 'Auto', 'Enter', and 'ESC'. Lines connect these buttons to their respective descriptions in the surrounding text.
- Input select buttons (p.9)**
 [Computer]: Switches the signal source to the images being input from the Computer/Component Video port.
 [S-Video/Video]: Switches the signal source being input from the S-Video port and the Video port.
 - [Menu] button (p.29)**
 Displays or hides the configuration menus.
 - [E-Zoom] button (⊖) (p.32)**
 Reduces the part of the image that has been enlarged using the [⊕] button.
 - [▲][▼][←][→] buttons (p.29, 34)**
 When a configuration menu or help menu is displayed, these buttons select menu items and setting values.
 When using the E-Zoom function, these buttons move the cross around the screen and scroll the image.
 - [Auto] button (p.17)**
 Use this button to automatically adjust computer images to the optimum when automatic setup is set to OFF.
 - Remote control light-emitting area (Quick Setup poster)**
 Outputs remote control signals.
 - [Power] button (p.9, 10)**
 Turns the projector power on and off.
 - [Color Mode] button (p.16)**
 Selects the color mode. The color mode changes in the order of Normal, Meeting, Presentation, Theater, Game and sRGB▶▶ each time the button is pressed.
 - [Freeze] button (p.31)**
 Keeps the current video or computer image on the screen.
 - [A/V Mute] button (p.31)**
 Momentarily turns off the audio and video.
 - [E-Zoom] button (⊕) (p.32)**
 Enlarges part of the image without changing the size of the projection area.
 - [Enter] button (p.29, 34)**
 Accepts a menu item or displays the next screen or menu while viewing a configuration menu or help menu.
 - [ESC] button (p.30)**
 Stops the current function.
 Displays the previous screen or menu while viewing a configuration menu.

Glossary

Following is an explanation of some of the terms used in this guide that may be unfamiliar or that were not explained in the text of this guide. Further information can be obtained by referring to other commercially-available publications.

Aspect ratio	The ratio between an image's length and its height. HDTV images have an aspect ratio of 16:9 and appear elongated. The aspect ratio for standard images is 4:3.
Color temperature	The temperature of an object which is emitting light. If the color temperature is high, the colors tend to take on a bluish tinge. If the color temperature is lower, the colors tend to take on a reddish tinge.
Component video	Video signals that have the video brightness signals and color signals separated, in order to provide better image quality. In high-definition TV (HDTV), it refers to images which consist of three independent signals: Y (luminance signal), and Pb and Pr (color difference signals).
Composite video	Video signals that have the video brightness signals and color signals mixed together. The type of signals commonly used by household video equipment (NTSC, PAL and SECAM formats). The carrier signal Y (luminance signal) and chroma (color) signal that are contained in the color bar are overlapped to form a single signal.
Contrast	The relative brightness of the light and dark areas of an image can be increased or decreased in order to make text and graphics stand out more clearly, or to make them appear softer. Adjusting this particular property of an image is called "contrast adjustment."
Cool-down	The cooling process for the projector's lamp unit continues even after the [Power] button on the projector's control panel or the remote control has been pressed to turn off the projector. After the lamp turns off, the cooling fan continues operating, but all button operations are disabled. The period of time during which this happens is called the "cool-down period." The cool-down period lasts for about 25 seconds. The actual time varies depending on the external air temperature.
Dolby Digital	A sound format developed by Dolby Laboratories. Normal stereo is a 2-channel format that uses two speakers. Dolby Digital is a 6-channel (5.1-channel) system that adds to this a center speaker, two rear speakers and a sub-woofer.
HDTV	An abbreviation for High-Definition Television. It refers to high-definition systems that satisfy the following conditions. Vertical resolution of 720p or 1080i or greater (p = progressive scanning , i = interlaced scanning) Screen aspect ratio of 16:9 Dolby Digital audio reception and playback (or output)
Interlaced scanning	A method of image scanning whereby the image data is divided into fine horizontal lines that are displayed in sequence starting from left to right and then from the top to the bottom of the screen. The even-numbered lines and odd-numbered lines are displayed alternately.
Progressive scanning	A method of image scanning whereby the image data from a single image is scanned sequentially from top to bottom to create a single image.
Refresh rate	The light-emitting element of a display maintains the same luminosity and color for an extremely short time. Because of this, the image must be scanned many times per second in order to refresh the light-emitting element. The number of refresh operations per second is called the "refresh rate," and is expressed in hertz (Hz).
Resize display	This function is used to project computer images that have a resolution of more than or less than the projector's panel resolution, so that they fill the whole projection area.
SDTV	An abbreviation for Standard Definition Television. It refers to standard television systems that do not satisfy the conditions of High Definition Television.
Security lock	A device consisting of a projector case with a hole in it that a commercially-available theft-prevention cable can be passed through in order to secure the device to a table or pillar. This projector is compatible with the Microsaver Security System manufactured by Kensington.
sRGB	An international standard for color intervals that was formulated so that colors that are reproduced by video equipment can be handled easily by computer operating systems (OS) and the Internet.

SVGA	A type of video signal with a resolution of 800 (horizontal) x 600 (vertical) dots that is used by IBM PC/AT-compatible computers.
S-Video	A video signal that has the luminance component and color component separated in order to provide better image quality. It refers to images that consist of two independent signals: Y (luminance signal), and C (color signal).
Sync. (Synchronization)	The signals output from computers have a specific frequency. If the projector frequency does not match this frequency, the resulting images will not be of a good quality. The process of matching the phases of these signals (the relative position of the crests and troughs in the signal) is called "synchronization." If the signals are not synchronized, problems such as flickering, blurriness and horizontal interference can occur.
Tracking	The signals output from computers have a specific frequency. If the projector frequency does not match this frequency, the resulting images will not be of a good quality. The process of matching the frequency of these signals (the number of crests in the signal) is called "tracking." If tracking is not carried out correctly, wide vertical stripes will appear in the projected image.
VGA	A type of video signal with a resolution of 640 (horizontal) x 480 (vertical) dots that is used by IBM PC/AT-compatible computers.
XGA	A type of video signal with a resolution of 1024 (horizontal) x 768 (vertical) dots that is used by IBM PC/AT-compatible computers.
YCbCr	The carrier signal that is contained in the color bar signal used in modern TV transmissions. The name comes from the Y (luminance) signal and the CbCr (chroma (color)) signals.
YPbPr	The carrier signal that is contained in the color bar signal used in high-definition TV (HDTV) transmissions. The name comes from the Y (luminance) signal and the PbPr (color difference) signals.



A

- A/V Mute button, 31
- A/V Mute option, 26
- About menu, 27
- accessories, 52
- adjusting image quality, 15
- adjusting screen image, 12
- Advanced menu, 26
- air filter
 - cleaning, 46
 - replacing, 51
- anti-theft device, 52
- aspect ratio, 16
- Aspect Ratio option, 23
- Audio menu, 25
- automatic setup for a computer, 17

B

- battery, 47
- Brightness option, 22

C

- carrying case, 52
- ceiling mount, 52
- Ceiling option, 26
- cinema filter, 15, 22, 24
- cleaning the projector, 46
- Color Adjustment option, 26
- color mode, 16
- Color Mode option, 23
- Color Mode Prompt option, 26
- Color option, 22
- computer, 24
 - automatic setup, 17
 - connecting, 9
 - monitors, 53
- configuration menus, 22
- Contrast option, 22
- control panel, 58

D

- Declaration of Conformity, 67

E

- EPSON
 - accessories, 52
 - cinema filter, 15
- EPSON Cinema Filter option, 22, 24
- Execute option, 28
- E-Zoom button, 32

F

- FCC compliance statement, 68
- focusing the image, 12
- Freeze button, 31
- Frequency option, 27

G

- getting help, 34
- glossary, 61

H

- Help function, 34

I

- image
 - adjusting quality of, 15
 - angle, 13
 - focusing, 12
- image, adjusting, 12
- indicators, 35
- Input Signal option, 23, 27

K

- Kensington anti-theft device, 52
- keystone distortion, 14
- Keystone option, 25

L

- Lamp option, 27
- lamp replacement, 48
- Language option, 26
- laptop
 - automatic setup, 17
 - connecting, 9
- lights, 35

M

- maintenance, 46
- monitors, 53

N

- No-Signal Msg. option, 25

O

- options for projector, 52

P

- Position option, 22
- Power button, 10
- power cable, 10
 - connecting, 8

problems, handling them, 33

projector

- appearance, 56
- carrying case, 52
- lights, 35
- maintenance, 46
- options, 52
- parts of, 57
- specifications, 54
- turning off, 10

Prompt option, 25

R

Rear Proj. option, 26

Refresh Rate option, 27

remote control, 47, 60

Reset All menu, 28

Reset Lamp Timer option, 27

Reset option, 23, 26, 27

Resolution option, 27

RGB, 24

S

safety information, 55

safety instructions, 44

screen image, adjusting, 12

Setting menu, 25

settings, 21

Sharpness option, 23

Sleep Mode option, 26

specifications, 54

sRGB, 23

sync, 19

SYNC Mode option, 27

SYNC Polarity option, 27

T

Tint option, 23

tracking, 18

troubleshooting, 33

turning off the projector, 10

V

Video menu, 22

Video Signal option, 23, 27

Video Source option, 27

W

warranty, 65

Z

Zoom button on control panel, 12

Warranty

Epson America, Inc. Limited Warranty

Basic One-Year Warranty and 90-Day Lamp Warranty

What Is Covered: Epson America, Inc. (“EPSON”) warrants to the first end user customer of the EPSON product enclosed with this limited warranty statement that the product, if purchased and used in the United States or Canada, conforms to the manufacturer’s specifications and will be free from defects in workmanship and materials for a period of one (1) year from the date of original purchase (except that the warranty period is 90 days for projector lamps).

What EPSON Will Do To Correct Problems: If you elect carry-in warranty service, please bring the product securely packaged in its original container or an equivalent, along with proof of the date of original purchase, to your EPSON Dealer or EPSON Customer Care Center. EPSON will, at its option, repair or replace on an exchange basis the defective unit, without charge for parts or labor. When warranty service involves the exchange of the product or of a part, the item replaced becomes EPSON property. The exchanged product or part may be new or previously repaired to the EPSON standard of quality. Exchange or replacement products or parts assume the remaining warranty period of the product covered by this limited warranty. However, each replacement lamp carries the limited 90-day warranty stated above.

What This Warranty Does Not Cover: This warranty covers only normal consumer use in the United States and Canada. For lamps, 24-hour-per-day use causes unusual strain and is not considered normal use. This warranty does not cover consumables (e.g., fuses), other than lamps. EPSON is not responsible for warranty service should the EPSON label or logo or the rating label or serial number be removed or should the product fail to be properly maintained or fail to function properly as a result of misuse, abuse, improper installation, neglect, improper shipping, damage caused by disasters such as fire, flood, and lightning, improper electrical current, software problems, interaction with non-EPSON products, or service other than by an EPSON Authorized Servicer. Postage, insurance, or shipping costs incurred in presenting your EPSON product for carry-in warranty service are your responsibility. If a claimed defect cannot be identified or reproduced in service, you will be held responsible for costs incurred.

THE WARRANTY AND REMEDY PROVIDED ABOVE ARE EXCLUSIVE AND IN LIEU OF ALL OTHER EXPRESS OR IMPLIED WARRANTIES INCLUDING, BUT NOT LIMITED TO, THE IMPLIED WARRANTIES OF MERCHANTABILITY OR FITNESS FOR A PARTICULAR PURPOSE. SOME LAWS DO NOT ALLOW THE EXCLUSION OF IMPLIED WARRANTIES. IF THESE LAWS APPLY, THEN ALL EXPRESS AND IMPLIED WARRANTIES ARE LIMITED TO THE WARRANTY PERIOD IDENTIFIED ABOVE. UNLESS STATED HEREIN, ANY STATEMENTS OR REPRESENTATIONS MADE BY ANY OTHER PERSON OR FIRM ARE VOID. EXCEPT AS PROVIDED IN THIS WRITTEN WARRANTY, NEITHER EPSON AMERICA, INC. NOR ITS AFFILIATES SHALL BE LIABLE FOR ANY LOSS, INCONVENIENCE, OR DAMAGE, INCLUDING DIRECT, SPECIAL, INCIDENTAL OR CONSEQUENTIAL DAMAGES, RESULTING FROM THE USE OR INABILITY TO USE THE EPSON PRODUCT, WHETHER RESULTING FROM BREACH OF WARRANTY OR ANY OTHER LEGAL THEORY. IF THE REMEDY ABOVE FAILS, EPSON’S ENTIRE LIABILITY SHALL BE LIMITED TO A REFUND OF THE PRICE PAID FOR THE EPSON PRODUCTS COVERED BY THIS LIMITED WARRANTY.

In Canada, warranties include both warranties and conditions.

Some jurisdictions do not allow limitations on how long an implied warranty lasts and some jurisdictions do not allow the exclusion or limitation of incidental or consequential damages, so the above limitations and exclusions may not apply to you.

This warranty gives you specific legal rights, and you may also have other rights, which vary from jurisdiction to jurisdiction.

To locate the Authorized EPSON Servicer nearest you, call the EPSON ConnectionSM at (800) 637-7661 + PIN or (562) 276-4394 in the U.S. and (905) 709-3839 in Canada or write to: Epson America, Inc., P.O. Box 93012, Long Beach, CA 90809-3012.

DECLARATION of CONFORMITY

According to 47CFR, Part 2 and 15
Class B Personal Computers and Peripherals; and/or
CPU Boards and Power Supplies used with Class B
Personal Computers

We: EPSON AMERICA, INC.
Located at: 3840 Kilroy Airport Way
MS: 3-13
Long Beach, CA 90806
Tel: 562-290-5254

Declare under sole responsibility that the product identified herein, complies with 47CFR Part 2 and 15 of the FCC rules as a Class B digital device. Each product marketed is identical to the representative unit tested and found to be compliant with the standards. Records maintained continue to reflect the equipment being produced can be expected to be within the variation accepted, due to quantity production and testing on a statistical basis as required by 47CFR 2.909. Operation is subject to the following two conditions: (1) this device may not cause harmful interference, and (2) this device must accept any interference received, including interference that may cause undesired operation.

Trade Name: EPSON
Type of Product: Projector
Model: EMP-30 / ELP-30

FCC Compliance Statement For United States Users

This equipment has been tested and found to comply with the limits for a Class B digital device, pursuant to Part 15 of the FCC Rules. These limits are designed to provide reasonable protection against harmful interference in a residential installation. This equipment generates, uses, and can radiate radio frequency energy and, if not installed and used in accordance with the instructions, may cause harmful interference to radio or television reception. However, there is no guarantee that interference will not occur in a particular installation. If this equipment does cause interference to radio and television reception, which can be determined by turning the equipment off and on, the user is encouraged to try to correct the interference by one or more of the following measures.

- Reorient or relocate the receiving antenna.
- Increase the separation between the equipment and receiver.
- Connect the equipment into an outlet on a circuit different from that to which the receiver is connected.
- Consult the dealer or an experienced radio/TV technician for help.

WARNING

The connection of a non-shielded equipment interface cable to this equipment will invalidate the FCC Certification or Declaration of this device and may cause interference levels which exceed the limits established by the FCC for this equipment. It is the responsibility of the user to obtain and use a shielded equipment interface cable with this device. If this equipment has more than one interface connector, do not leave cables connected to unused interfaces. Changes or modifications not expressly approved by the manufacturer could void the user's authority to operate the equipment.