

**BenQ**

PE7700 Digital Projector

Home Theater

User's Manual

Welcome

## Copyright

Copyright © 2005 by BenQ Corporation. All rights reserved. No part of this publication may be reproduced, transmitted, transcribed, stored in a retrieval system or translated into any language or computer language, in any form or by any means, electronic, mechanical, magnetic, optical, chemical, manual or otherwise, without the prior written permission of BenQ Corporation.

## Disclaimer

BenQ Corporation makes no representations or warranties, either expressed or implied, with respect to the contents hereof and specifically disclaims any warranties, merchantability or fitness for any particular purpose. Further, BenQ Corporation reserves the right to revise this publication and to make changes from time to time in the contents hereof without obligation of BenQ Corporation to notify any person of such revision or changes.

\*DLP, Digital Micromirror Device and DMD are trademarks of Texas Instruments. Others are copyrights of their respective companies or organizations.

## Table of Contents

<b>Safety, regulatory and legal information .....</b>	<b>5</b>
FCC statement (for US users) .....	5
EEC statement (for European users) .....	5
MIC statement .....	5
Safety instructions .....	5
Moisture condensation .....	8
Avoid volatile liquid .....	8
Disposal .....	8
<b>Overview .....</b>	<b>9</b>
Features .....	9
Shipping contents .....	10
Optional accessories .....	10
Installing or replacing batteries .....	10
Projector exterior view .....	11
Front / upper side .....	11
Rear side .....	11
Bottom and right sides .....	11
Connector panel .....	11
Controls and functions .....	12
Control panel .....	12
Remote control .....	12
<b>Positioning your projector .....</b>	<b>14</b>
Choosing a location .....	14
Obtaining a preferred projected image size .....	15
Installation for a 16:9 ratio screen .....	15
Installation for a 4:3 ratio screen .....	16
<b>Connecting various equipment .....</b>	<b>17</b>
Connecting video inputs .....	17
Connecting HDMI devices .....	17
Connecting component video devices .....	17
Connecting S-video or video devices .....	18
Connecting a computer .....	18
<b>Using the projector and remote control .....</b>	<b>19</b>
Preparations .....	19
Turning the power on .....	19
Switching input signals .....	19
Adjust the image .....	20
Adjusting the angle height .....	20

Auto-adjusting the image .....	20
Fine-tuning the image size and clarity .....	20
Optimizing the image .....	20
1. Selecting a preset mode .....	21
2. Selecting aspect ratio .....	21
3. Other adjustments .....	21
Personalizing the projector menu display .....	22
Saving and loading the video memory .....	22
Using PIP (Picture-In-Picture) and POP (Picture-On-Picture) functions	22
Turning the power off .....	23
<b>Menus .....</b>	<b>24</b>
Menu structure .....	24
Using the menus .....	25
Picture menu .....	25
Display menu .....	26
Options menu .....	27
Setup menu .....	27
Advanced menu .....	28
<b>Additional information .....</b>	<b>29</b>
Care of the projector .....	29
Cleaning the lens .....	29
Cleaning the projector case .....	29
Cleaning and replacing the dust filter .....	29
Storing the projector .....	30
Transporting the projector .....	30
Replacing the lamp (Contact your BenQ dealer for assistance) .....	30
Indicators .....	32
Troubleshooting .....	33
Specifications .....	34
Optical characteristics .....	34
Electrical characteristics .....	34
Input .....	34
General characteristics .....	34
Dimensions .....	34

# 1 Safety, regulatory and legal information

Thank you for your purchase of this quality BenQ video projector! It has been designed to provide you with a home theater viewing experience. For the best result, please read this manual carefully as it is your guide through the control menus and operation.

## FCC statement (for US users)

This equipment has been tested and found to comply with the limits for a Class B digital device, pursuant to Part 15 of the FCC Rules. These limits are designed to provide reasonable protection against harmful interference in a residential installation.

**CLASS B:** This equipment generates, uses and can radiate radio frequency energy and, if not installed and used in accordance with the instructions, may cause harmful interference to radio communications. However, there is no guarantee that interference will not occur in a particular installation. If this equipment does cause harmful interference to radio or television reception, which can be determined by turning the equipment off and on, the user is encouraged to try to correct the interference by one or more of the following measures:

- Reorient or relocate the receiving antenna.
- Increase the distance between the equipment and receiver.
- Connect the equipment into an outlet on a circuit different from that to which the receiver is connected.
- Consult the dealer or an experienced radio/TV technician for help.

## EEC statement (for European users)

This machine was tested against the 89/336/EEC (European Economic Community) for EMC (Electro Magnetic Compatibility) and fulfills these requirements.

## MIC statement

### B class equipment (Household purpose info/telecommunications equipment)

As this equipment has undergone EMC registration for household purpose, this product can be used in any area including residential areas.

## Safety instructions

Your BenQ projector is designed and tested to meet the latest standards for safety of information technology equipment. However, to ensure safe use of this product, it is important that you follow the instructions mentioned in this manual and marked on the product.

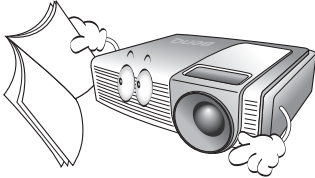
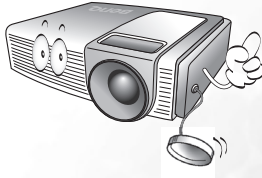
Safety instructions	
<p>1. Please read this user's manual before you operate your projector. Save this user's manual for future reference.</p> 	<p>2. Always open the lens shutter or remove the lens cap when the projector lamp is on.</p> 

## Safety instructions (continued)

3. Refer servicing only to qualified service personnel.

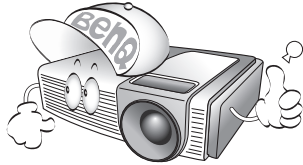

4. To reduce the risk of electric shock, do not disassemble this appliance. There are no user serviceable parts inside. Take it to a qualified technician when service or repair is required. Incorrect reassembly can cause a malfunction of the projector or electric shock when the appliance is subsequently used.

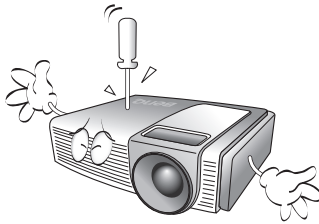

5. Do not look straight at the projector lens during operation. The intense light beam may damage your eyes.

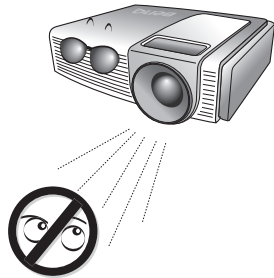

6. Never replace the lamp assembly or any electronic components unless the projector is unplugged.

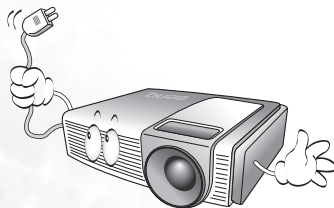

7. In some countries, the line voltage is NOT stable. This projector is designed to operate safely with a mains voltage between 100 and 240 volts AC, but could fail if power cuts or surges of  $\pm 10$  volts occur. In areas where the mains voltage may fluctuate or cut out, it is recommended that you connect your projector through a power stabilizer, surge protector or uninterruptible power supply (UPS).

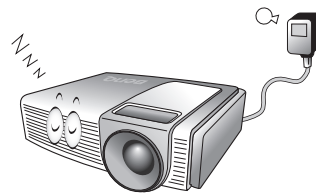

8. The lamp becomes extremely hot during operation. Allow the projector to cool for approximately 45 minutes prior to removing the lamp assembly for replacement.

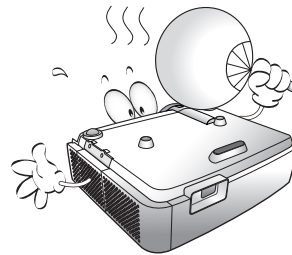

9. Do not operate lamps beyond the rated lamp life. Excessive operation of lamps beyond the rated life could cause them to break on rare occasions.

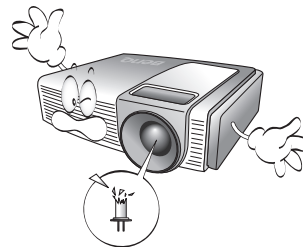

**Safety instructions (continued)**

10. This product is capable of displaying inverted images for ceiling mount installation. Please use BenQ's Ceiling Mounting Kit for mounting the projector and ensure it is securely installed.

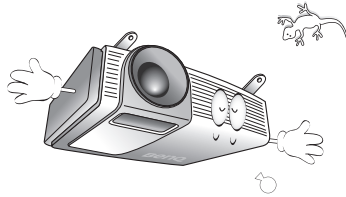

11. Do not block the ventilation holes.
- Do not place the projector on a blanket, bedding or any other soft surface.
  - Do not cover the projector with a cloth or any other item.
  - Do not place inflammables near the projector.

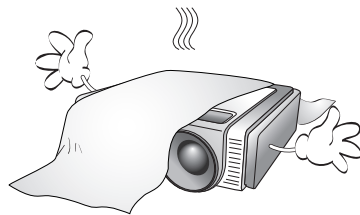

If the ventilation holes are seriously obstructed, overheating inside the projector may cause damage to the lamp, the projector to fail or result in fire.

12. Do not place this product on an unstable cart, stand, or table. The product may fall, sustaining serious damage.

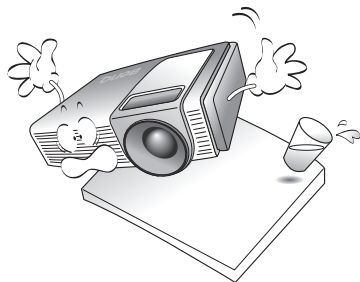

13. Do not place the projector in any of the following environments.
- Space that is poorly ventilated or confined. Allow at least 50 cm clearance from walls and free flow of air around the projector.
  - Locations where temperatures may become excessively high, such as the inside of a car with all windows rolled up.
  - Locations where excessive humidity, dust, or cigarette smoke may contaminate optical components, shortening the projector's lifespan and darkening the screen.

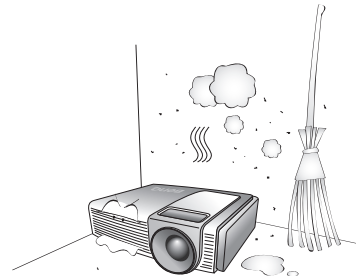

- Locations near fire alarms
- Locations with an ambient temperature above 40°C / 104°F
- Locations where altitude are higher than 10000 feet.

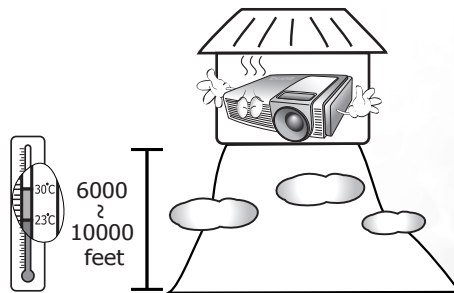

### Safety instructions (continued)

14. Always place the projector on a level, horizontal surface during operation.
- Do not use if tilted at an angle of more than 10 degrees left to right, nor at angle of more than 15 degrees front to back. Using the projector when it is not fully horizontal may cause a malfunction of, or damage to, the lamp or other components.

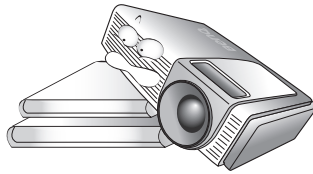

15. Do not stand the projector on end vertically. Doing so may cause the projector to fall over, causing injury or resulting in damage to it.

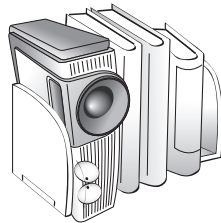

16. Do not step on the projector or place any objects upon it. Besides probable physical damage to the projector, doing so may result in accidents and possible injury.

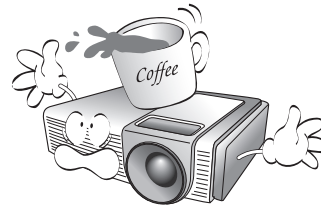

17. Do not place liquids near or on the projector. Liquids spilled into the projector may cause it to fail. If the projector does become wet, disconnect it from the power supply's wall socket and call BenQ to have the projector serviced.

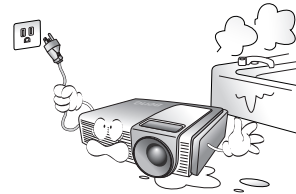

### Moisture condensation

Never operate the projector immediately after moving it from a cold location to a hot location. When the projector is exposed to such a change in temperature, moisture may condense on the crucial internal parts. To prevent the projector from possible damage, do not use the projector for at least 2 hours when there is a sudden change in temperature.

### Avoid volatile liquid

Do not use volatile liquids, such as insecticide or some types of cleaner, near the projector. Do not have rubber or plastic products touching the projector for a long time. They will leave marks on the finish. If cleaning with a chemically saturated cloth, be sure to follow the product's safety instructions.

### Disposal

This product contains the following materials which are harmful to human bodies and environment.

- Lead, which is contained in solder.
- Mercury, which is used in lamp.

To dispose the product or used lamps, consult your local environment authorities for regulations.



## 2 Overview

### Features

#### ■ High Picture Quality

This single DMD DLP™ projector provides excellent picture quality, a high contrast ratio and very good color uniformity.

#### ■ Dynamic Performance and Rich Gray-Scale

With a 6-segment color wheel, the projector can attain refresh rates of up to 300 Hz which provides dynamic performance and rich gray-scale without the 'color flicker' or 'rainbow effect' associated with other single-DMD DLP™ projectors.

#### ■ Sealed Optical Engine

The optical engine uses a high-quality lens for maximizing optical performance. The sealed optical engine prevents light leakage and any dust from entering the engine, which could cause annoying 'spots' in the projected image.

#### ■ Fixed CAT optical lens for robust contrast ratio 2500:1

The projector is added an aperture in lens to get the optimization of the contrast ratio and brightness.

#### ■ Low-Noise Operation

The projector's unique cooling system design prevents annoying fan noise, and is rated at less than 29 dB at normal mode and 26 dB at Economic mode.

#### ■ Wide Variety of Inputs

The projector can support a wide variety of video formats. The component inputs are used to connect the projector to HDTV receivers and DVD players. They use RCA connectors to minimize signal degradation that may be caused by installations that have longer cables.

#### ■ HDTV Ready

The projector is compatible with 480i, 480P, 576i, 576p, 1080i and 720P formats.

#### ■ De-interlacing with 3:2 Pull-Down

Using BenQ's proprietary de-interlacing technology, the projector provides exceptional scaling and film-to-video (3:2 pull-down) conversion for the most artifact-free images possible.

#### ■ PIP/POP function

The Picture-In-Picture (PIP) and Picture-On-Picture (POP) functions allow you to display two inputs on the screen at the same time.

#### ■ Video Memory

This projector allows users to store up to three different configurations in its video memories to optimize the image for different types of signal.

#### ■ Multilingual OSD (On-Screen Display) menus

## Shipping contents

The projector is shipped with the cables required for connection to a video and PC equipment. Some of the items may not be available depending on the region. Please check with your place of purchase.

☞ **Some of the accessories may vary from country to country.**

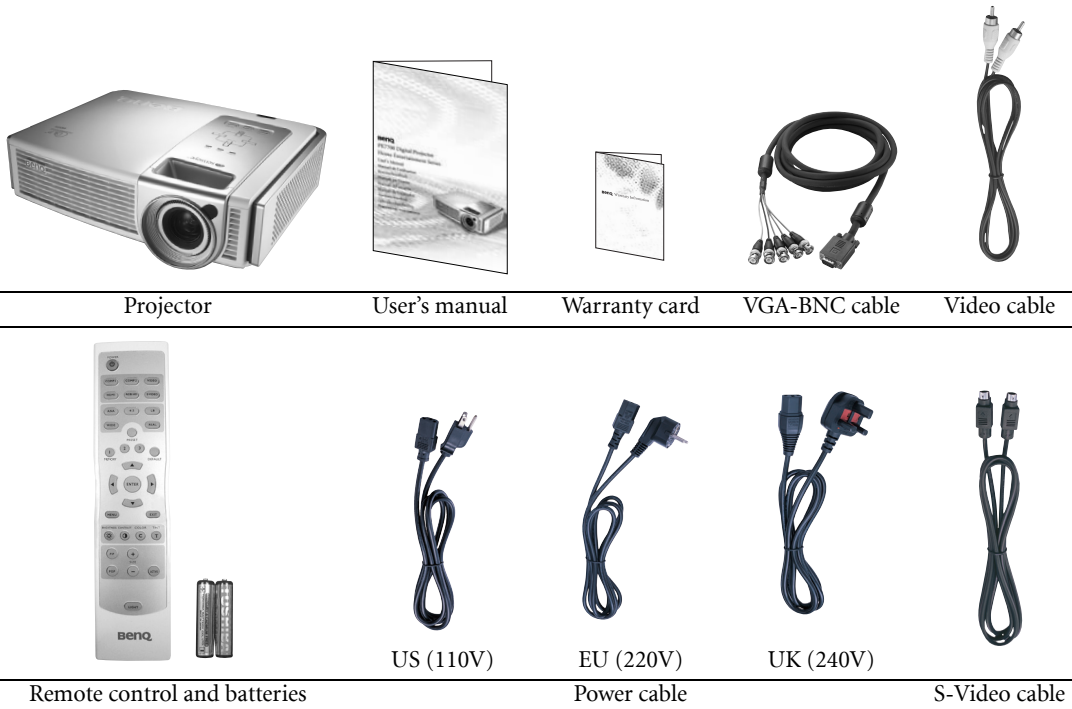

### Optional accessories

1. HDMI cable
2. Ceiling mounting kit

### Installing or replacing batteries

Push on the cover and slide it to open. Install two AAA batteries with the correct polarities, then close the cover

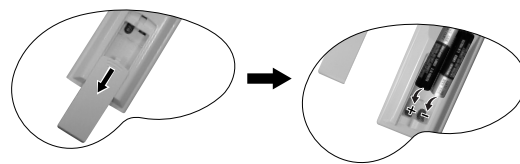

### ☞ Notes on batteries

- Do not mix an old battery with a new one, or mix different types of batteries.
- Avoid leaving the remote control and batteries in an excessive heat or humid environment like the kitchen, bathroom, sauna, sunroom, or in a closed car.
- Dispose of used batteries according to the battery manufacturer's instructions and local environment regulations for your region.
- If the remote control will not be used for an extended period of time, remove the batteries to avoid damage to the control from possible battery leakage.

## Projector exterior view

### Front / upper side

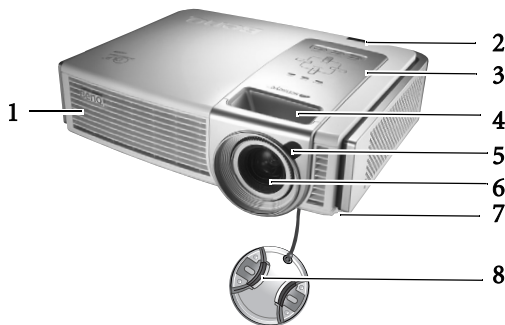

1. Ventilation holes (exhaust)
2. Rear IR sensor
3. Control panel (See page 12 for detailed information.)
4. Focus ring and zoom ring
5. Front IR sensor
6. Projection lens
7. Dust filter grill
8. Lens cap

### Rear side



9. Connector panel
10. Main AC power switch
11. Power cable socket

### Bottom and right sides



12. Front adjuster feet
13. Ceiling mounting holes
14. Kensington lock slot



### Connector panel

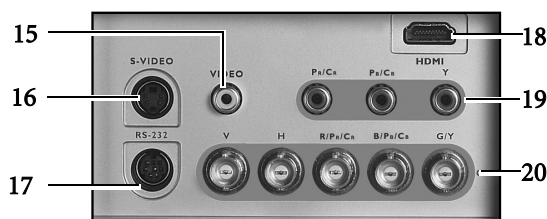

15. Composite Video input (RCA jack)
16. S-Video input (mini DIN 4-pin)
17. RS-232C input (for servicing)
18. HDMI (High-Definition Multimedia Interface) input  
Supports an all-digital video source, such as a set-top box, DVD player, digital TV (DTV) or other digital AV equipment.
19. Component video input (RCA jacks)  
Supports Y/PB/PR or Y/CB/CR signal input.
20. RGB/ HDTV input (BNC)  
Supports Y/PB/PR, Y/CB/CR, or RGB video signal input or PC signal input.

## Controls and functions

### Control panel

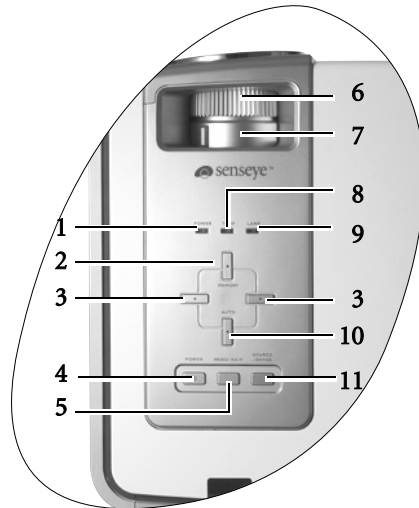

1. **POWER indicator light (Refer to page 32 for more information.)**  
Lights up or flashes when the projector is under operation.
2. **MEMORY ▲**  
Sequentially recalls settings 1 ~ 3 saved to memory.
3. **ARROWS (◀/▶)**  
When the on-screen menu is activated, the #2, #3, and #10 are used as directional arrows to select the desired menu items and to make adjustments.
4. **POWER (Refer to pages 19, 23 and 32 for more information.)**  
Press and hold this button to turn the projector on when it is in the standby mode. Or press this button twice to turn the projector off.
5. **MENU / EXIT**  
Turns the on-screen display control menu on.  
Exits and saves the menu settings.
6. **Focus Ring (Refer to 20 for more information.)**  
Adjusts the focus of the projected image.
7. **Zoom Ring (Refer to 20 for more information.)**  
Adjusts the size of the projected image.
8. **Temperature warning light (Refer to page 32 for more information.)**  
Lights up or flashes if the projector's temperature becomes too high.
9. **LAMP indicator light (Refer to 32 for more information.)**  
Indicates the status of the lamp.  
Lights up or flashes when the lamp has developed a problem. Please contact your BenQ dealer for assistance.
10. **AUTO ▼**  
Automatically determines the best picture timings for the displayed image.
11. **SOURCE / ENTER (Refer to page 25 for more information.)**  
Switches input sources sequentially or opens the selected item of menu when the on-screen menu is activated.

### Remote control

#### Notes on remote control operation

- Make sure there is nothing between the remote control and the IR sensor on the projector that might obstruct the infrared beam.
- The effective range of the remote control is up to 8 meters from the front of the projector or 8 meters from the rear of the projector. The remote control must be held at an angle within 45 degrees of the projector's IR remote control sensor.

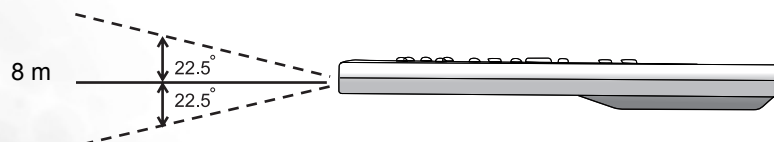

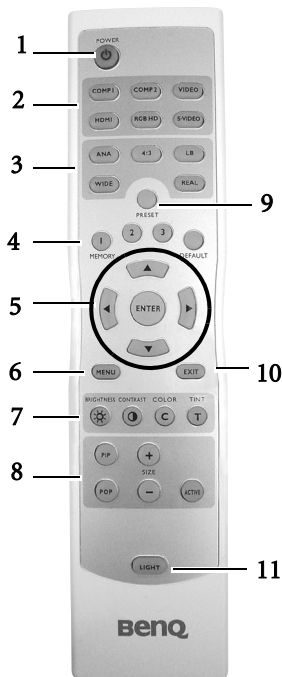

1. **POWER** (Refer to pages 19, 23 and 32 for more information.)  
Press and hold this button to turn the projector on when it is in the standby mode. Or press this button twice to turn the projector off.
2. **Source buttons** (Refer to 27 for more information.)  
Selects an input source to display on the projector.
3. **Aspect buttons** (Refer to 26 for more information.)  
Selects the image aspect ratio to suit the input signal.
4. **Memory (1, 2, 3 and default) buttons** (Refer to 26 for more information.)  
Restores settings saved in memory locations 1, 2, and 3, or restores the default settings for the current input source.
5. **Arrows (▲/◀/▼/▶)** (Refer to 25 for more information.)  
Used to select the desired menu or to make adjustments.
6. **MENU** (Refer to 25 for more information.)  
Turns the on-screen display control menu on or off.
7. **Picture quality adjustment buttons** (Refer to 25 for more information.)  
**ENTER** (Refer to 25 for more information.)  
Opens the selected items of the menu.
8. **PIP and POP buttons** (Refer to page 22 for more information.)  
To turn the PIP or POP function on or off, press the **PIP** or **POP** button. Adjust the size of the PIP image by pressing the + or - button. If you want to switch between main window and sub-window, or left window and right window, toggle **ACTIVE** so that you can adjust the image settings in the selected window.
9. **Preset** (Refer to page 21 for more information.)  
Selects one of the preset modes to suit your program type.
10. **EXIT** (Refer to 25 for more information.)  
Exits and saves any changes made using the menu.
11. **LIGHT**  
Turns the remote control's backlight on.

## 3 Positioning your projector

### Choosing a location

Your projector is designed to be installed in one of four possible installation locations:

1. Floor in front of screen;
2. Ceiling in front of screen;
3. Floor at rear of screen; or
4. Ceiling at rear of screen.

Your room layout or personal preference will dictate which installation location you select. Take into consideration the size and position of your screen, the location of a suitable power outlet, the location and distance between the projector, and the rest of your equipment.

#### I. Floor front

Select this location with the projector placed near the floor in front of the screen. This is the most common way to position the projector for quick setup and portability.

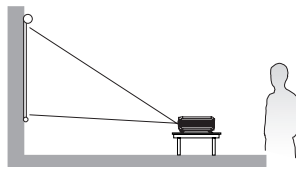

#### II. Ceiling front

Select this location with the projector suspended from the ceiling in front of the screen.

Purchase the BenQ Projector Ceiling Mounting Kit from your dealer to mount your projector on the ceiling.

Set **Ceiling Front** in the **Setup > Mirror** menu after you turn the projector on.

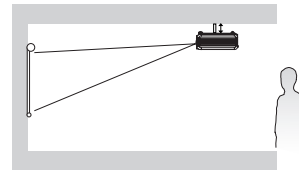

#### III. Floor rear

Select this location with the projector placed near the floor behind the screen.

Note that a special rear projection screen is required.

Set **Floor Rear** in the **Setup > Mirror** menu after you turn the projector on.

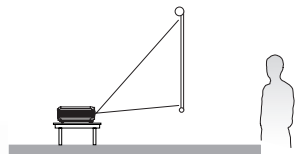

#### IV. Ceiling rear

Select this location with the projector suspended from the ceiling behind the screen.

Note that a special rear projection screen and the BenQ Projector Ceiling Mounting Kit are required for this installation location.

Set **Ceiling Rear** in the **Setup > Mirror** menu after you turn the projector on.

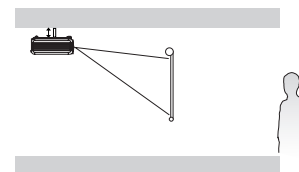

## Obtaining a preferred projected image size

The distance from the projector lens to the screen, the zoom setting, and the video format each factors in the projected image size. BenQ has provided separate tables of dimensions for both 16:9 and 4:3 screen ratios to assist you in determining the ideal location for your projector.

1. Determine the aspect ratio of your screen, (16:9 or 4:3)?
2. Select the **Screen Size** you desire from the 16:9 ratio screen dimension table or 4:3 ratio screen dimension table below, according to what screen type you have. Install the projector at a distance between the **Min.** and **Max. Projection Distance** values in the table.
3. Decide the preferred height of your projector.

For example, if you are using a 16:9 screen with 80 inches diagonal, you are suggested to place your projector within a range between 2.34m to 3.18m from the screen. **The ideal height of your projector lens center will be level with the bottom or top side of the screen.**

### Installation for a 16:9 ratio screen

#### Ceiling Installation

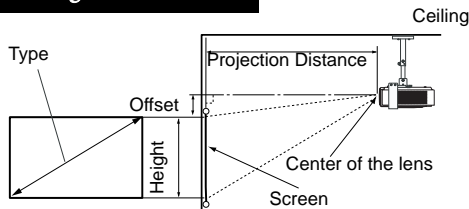

#### Floor Installation

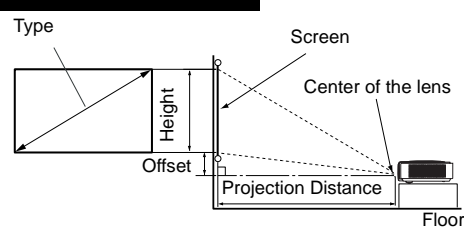

### 16:9 (widescreen) ratio screen dimension table

Screen Size			Projection Distance		Height Offset	
Type (inch) / (cm)	Height (inch) / (cm)	Width (inch) / (cm)	Min. (inch) / (cm)	Max. (inch) / (cm)	Tele (inch) / (cm)	Wide (inch) / (cm)
37 / 94	18.1 / 46	32.3 / 82	42.5 / 108	57.9 / 147	0 / 0	0 / 0
50 / 127	24.4 / 62	43.7 / 111	57.5 / 146	78.4 / 199	0 / 0	0 / 0
60 / 152	29.5 / 75	52.4 / 133	68.9 / 175	93.7 / 238	0 / 0	0 / 0
70 / 178	34.8 / 87	61.0 / 155	80.3 / 204	109.5 / 278	0 / 0	0 / 0
80 / 203	39.4 / 100	69.7 / 177	92.1 / 234	125.2 / 318	0 / 0	0 / 0
90 / 229	44.1 / 112	78.4 / 199	103.5 / 263	140.6 / 357	0 / 0	0 / 0
100 / 254	49.2 / 125	87.0 / 221	115.0 / 292	156.3 / 397	0 / 0	0 / 0
110 / 279	54.8 / 137	96.1 / 244	126.4 / 321	172.1 / 437	0 / 0	0 / 0
120 / 305	58.7 / 149	104.7 / 266	137.8 / 350	187.4 / 476	0 / 0	0 / 0
130 / 325	63.8 / 162	113.4 / 288	149.6 / 380	203.2 / 516	0 / 0	0 / 0
140 / 356	68.5 / 174	122.1 / 310	161.0 / 409	218.9 / 556	0 / 0	0 / 0
150 / 381	73.6 / 187	130.7 / 332	172.4 / 438	234.7 / 596	0 / 0	0 / 0
160 / 406	78.4 / 199	139.4 / 354	183.9 / 467	250.0 / 635	0 / 0	0 / 0
170 / 432	83.5 / 212	148.0 / 376	195.3 / 496	265.8 / 675	0 / 0	0 / 0
180 / 457	88.2 / 224	156.7 / 398	207.1 / 526	281.5 / 715	0 / 0	0 / 0
190 / 483	93.3 / 237	165.8 / 421	218.5 / 555	296.9 / 754	0 / 0	0 / 0
200 / 508	98.0 / 249	174.4 / 443	229.9 / 584	312.6 / 794	0 / 0	0 / 0
250 / 635	122.4 / 311	217.7 / 553	287.4 / 730	390.9 / 993	0 / 0	0 / 0
300 / 762	147.2 / 374	261.4 / 664	344.9 / 876	468.9 / 1191	0 / 0	0 / 0

**The above numbers are approximate and may be slightly different from the actual measurements. Only the recommended screen sizes are listed. If the your screen size is not in the table above, please contact your BenQ dealer for assistance.**

An examination of the table reveals that you can place the projector lens in the range from 1.08 to 11.91m distance from the screen, which will give you a projected image from 0.82 x 0.46m to 6.64 x 3.74m full screen.

### Installation for a 4:3 ratio screen

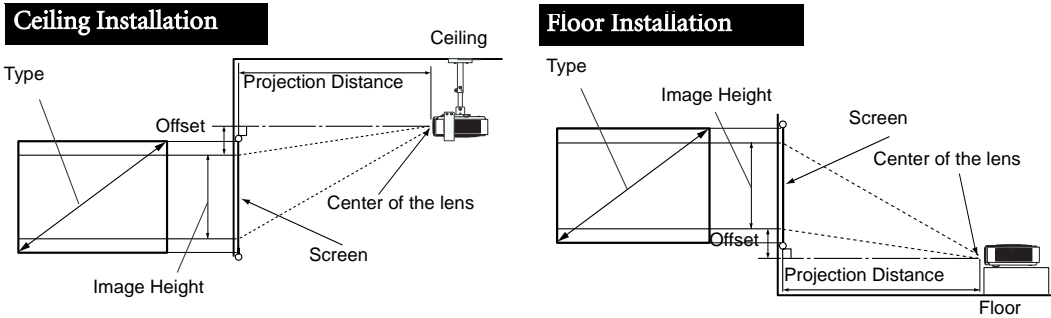

### 4:3 (standard) ratio screen dimension table:

Screen Size			Projection Distance		Height Offset		Image Height (inch) / (cm)
Type (inch) / (cm)	Height (inch) / (cm)	Width (inch) / (cm)	Min. (inch) / (cm)	Max. (inch) / (cm)	Tele (inch) / (cm)	Wide (inch) / (cm)	
37 / 94	22.1 / 56	29.5 / 75	39.0 / 99	53.2 / 135	0 / 0	0 / 0	16.5 / 42
50 / 127	29.9 / 76	40.2 / 102	52.8 / 134	71.7 / 182	0 / 0	0 / 0	22.4 / 57
60 / 152	35.8 / 91	48.0 / 122	63.0 / 160	85.8 / 218	0 / 0	0 / 0	27.2 / 69
70 / 178	42.1 / 107	55.9 / 142	73.62 / 187	100.4 / 255	0 / 0	0 / 0	31.5 / 80
80 / 203	48.0 / 122	64.2 / 163	84.3 / 214	114.6 / 291	0 / 0	0 / 0	35.8 / 91
90 / 229	53.9 / 137	72.1 / 183	94.9 / 241	128.7 / 327	0 / 0	0 / 0	40.6 / 103
100 / 254	59.8 / 152	79.9 / 203	105.1 / 267	143.3 / 364	0 / 0	0 / 0	44.9 / 114
110 / 279	66.1 / 168	88.2 / 224	115.8 / 294	157.5 / 400	0 / 0	0 / 0	49.6 / 126
120 / 305	72.1 / 183	96.1 / 244	126.4 / 321	171.7 / 436	0 / 0	0 / 0	53.9 / 137
130 / 325	78.0 / 198	103.9 / 264	137.0 / 348	186.2 / 473	0 / 0	0 / 0	58.7 / 149
140 / 356	83.9 / 213	111.8 / 284	147.2 / 374	200.4 / 509	0 / 0	0 / 0	63.0 / 160
150 / 381	90.2 / 229	120.1 / 305	157.9 / 401	214.6 / 545	0 / 0	0 / 0	67.3 / 171
160 / 406	96.1 / 244	128.0 / 325	168.5 / 428	229.1 / 582	0 / 0	0 / 0	72.1 / 183
170 / 432	102.0 / 259	135.8 / 345	179.1 / 455	243.3 / 618	0 / 0	0 / 0	76.4 / 194
180 / 457	107.9 / 274	144.1 / 366	189.3 / 481	257.9 / 655	0 / 0	0 / 0	81.1 / 206
190 / 483	114.2 / 290	152.0 / 386	200.0 / 508	272.1 / 691	0 / 0	0 / 0	85.4 / 217
200 / 508	120.1 / 305	159.8 / 406	210.6 / 535	286.2 / 727	0 / 0	0 / 0	90.2 / 229
250 / 635	150.0 / 381	200.0 / 508	263.0 / 668	357.9 / 909	0 / 0	0 / 0	112.6 / 286
300 / 762	180.0 / 457	239.0 / 610	315.8 / 802	429.5 / 1091	0 / 0	0 / 0	135.0 / 343

**The above numbers are approximate and may be slightly different from the actual measurements. Only the recommended screen sizes are listed. If the your screen size is not in the table above, please contact your BenQ dealer for assistance.**

An examination of the table reveals that you can place the projector lens in the range from 0.99 to 10.91m distance from the screen, which will give you a projected image from 0.75 x 0.42m to 6.1 x 3.43m.



## 4 Connecting various equipment

You can connect the projector to any type of video equipment, such as a VCR, DVD player, digital tuner, cable or satellite box, video game console or digital camera. You can also connect it to a desktop or laptop PC or Apple Macintosh system.

The projector can connect multiple video equipment at the same time by using different cables. Make sure you select the correct input to display.

When connecting any signal source to the projector, be sure to:

1. Turn off all equipment before making any connections.
2. Use the correct signal cables for each source.
3. Ensure the cables are firmly inserted.
4. Connect all audio signals to external speakers. This projector is not equipped with speakers.

 In the connections shown below, only certain cables are included with the projector (see page 10). Other cables are commercially available from electronics stores.

### Connecting video inputs

#### Connecting HDMI devices

You must use an HDMI cable when connecting the projector to an HDMI device. The HDMI (High-Definition Multimedia Interface) terminal supports uncompressed video data transmission between compatible devices such as DTV tuners, DVD players, and displays over a single cable. It provides a pure digital viewing and listening experience.

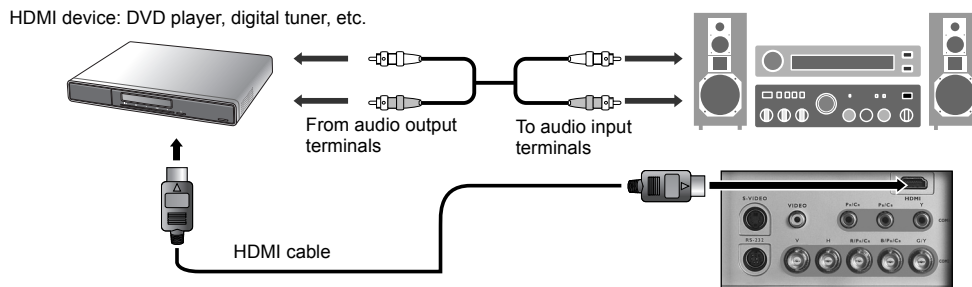

 Because HDMI is an evolving technology, it is possible that some devices may not operate properly with the projector.

#### Connecting component video devices

Be sure to match the corresponding colors between the cables and the terminals.

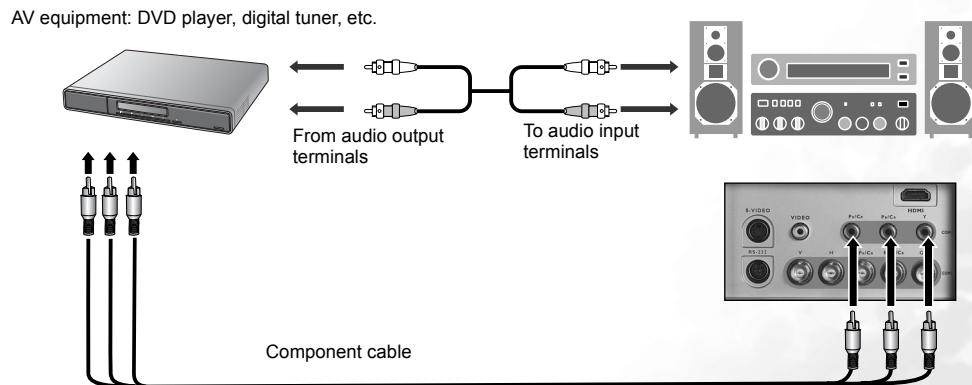

## Connecting S-video or video devices

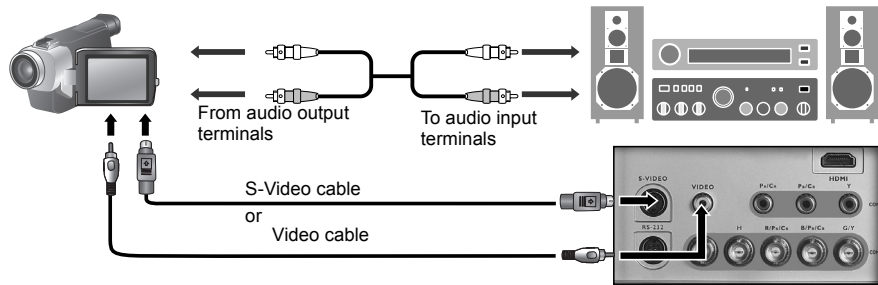

## Connecting a computer

Connect the projector to a computer with a VGA-BNC cable.

Laptop or desktop computer

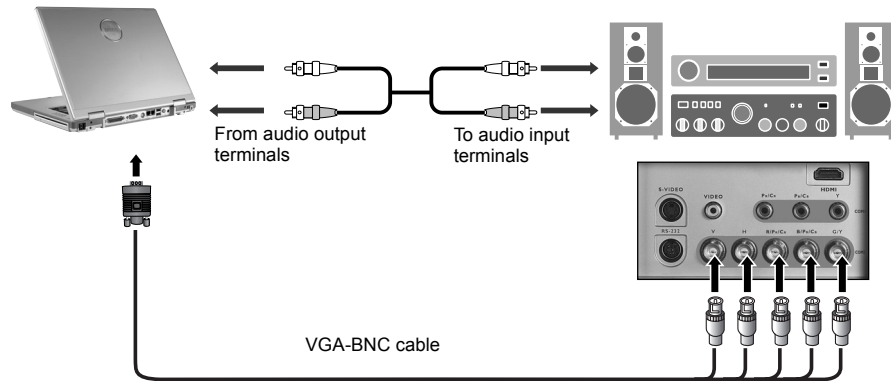

☞ If the selected video image is not displayed after the projector is turned on and the correct video source has been selected, please check that the video source is turned on and operating correctly. Also check that the signal cables have been connected correctly.

☞ Many laptops do not turn on their external video ports when connected to a projector. Usually a key combo such as FN + F3 or CRT/LCD key turns the external display on/off. Locate a function key labeled CRT/LCD or a function key with a monitor symbol on the laptop. Press FN and the labeled function key simultaneously. Refer to your laptop's documentation to learn your laptop's key combination.

## 5 Using the projector and remote control

### Preparations

1. Turn all of the connected equipment on.
2. Remove the lens cap.
3. Plug the supplied power cable into the AC inlet on the rear of the projector and turn the main AC power switch on.

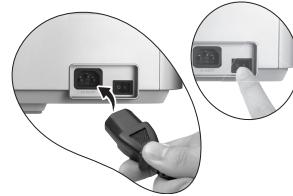
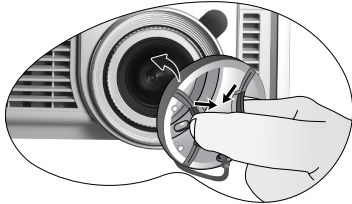

4. Plug the power cable into a wall socket and turn the wall switch on.

### Turning the power on

Follow the steps below.

1. Make sure the Power light is orange after power has been applied and the main AC power switch is turned on.
2. Press and hold the **POWER** button on the projector or remote control to turn the projector on.

 **The POWER button may not work while the projector is warming up.**

3. The fans will be running. A start-up image shows on the screen for a few seconds.
4. "Searching..." will be displayed on the screen before the projector identifies the input signal. This message will remain on the screen until a valid signal is detected.
5. If the horizontal frequency of the input signal exceeds the range of the projector, a message reading "Unsupported timing" will be displayed on-screen. This message will remain on-screen until you change the input signal.



### Switching input signals

The projector can be connected to multiple equipment at the same time. To sequentially select input signals, press one of the Source buttons on the remote control or **SOURCE/ENTER** on the projector.

- When the projector is turned on, it will search for the input source you last selected.
- If you need to use the PIP or POP function, refer to page 22 for advanced operation.

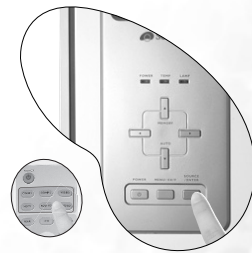

## Adjust the image

### Adjusting the angle height

There are two adjuster feet on the bottom of the projector. These adjuster feet change the image height and projection angle. To adjust the projector, you can screw the height adjuster feet to fine-tune the projection angle.



- ☞ **If the screen and the projector are not perpendicular to each other, the projected image becomes vertical trapezoidal. To correct this problem, adjust the value of Keystone in the Setup menu.**

### Auto-adjusting the image

With one press of the Auto button on the projector, the built-in intelligent auto-adjustment function will re-adjust the values of Frequency and Clock to provide the best image quality.

The current source information will be displayed at the bottom right corner of the screen for 3 seconds.

- ☞ **The screen will be blank while the auto-adjustment is functioning.**



### Fine-tuning the image size and clarity

1. Adjust the projected image to the size that you need using the zoom ring.

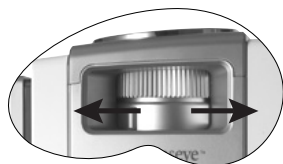
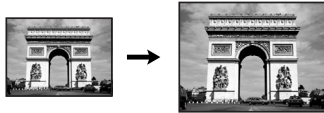

2. Then sharpen the image by rotating the focus ring.

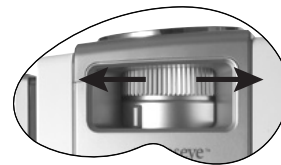

### Optimizing the image

To optimize the image, use the remote control or on-screen menus. For the operation of on-screen menus, please refer to page 25.

The following steps are optional. You do not need to follow every step. It depends on the image quality you desire.

## 1. Selecting a preset mode

Select a preset mode on the remote control, or in **Picture > Preset Mode** menu. There are 5 modes available for each input. These modes are with preset values suitable for various projection purposes.

- **Preset Cinema Mode:** with well-balanced color saturation and contrast but lowest brightness. It is suitable for enjoying dark movie contents in a totally dark environment.
- **Preset Home Theater Mode:** is brighter than Cinema Mode. A little bit ambient light is allowed when using the projector with this mode.
- **Preset Family Room Mode:** Brightness is emphasized in this mode. It is good for watching TV program, playing games or seeing bright movies.
- **Preset Photo Mode:** designed for viewing digital pictures in a living room.
- **Preset Gaming Mode:** is suitable for playing video games in a bright living room.

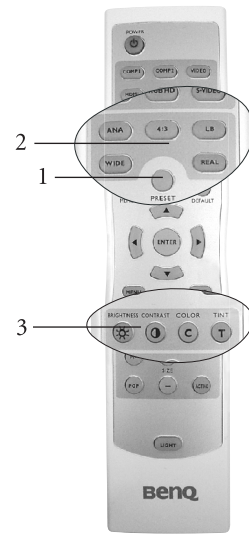

## 2. Selecting aspect ratio

The aspect ratio is the ratio of image width to image height. HDTV and most DVDs are 16:9, which is the default for this projector. Most TV shows are 4:3.

Change the image ratio using the Aspect buttons on the remote control or in **Display > Aspect Ratio** menu. Select an aspect ratio to suit the format of the video signal. There are five aspect ratios available:

In the pictures below, the black portions are inactive areas and the white portions are active areas.

<p>1. <b>Anamorphic:</b> Scales an image so that it is displayed in the center of the screen with a 16:9 aspect ratio.</p>	<p>4. <b>Wide:</b> A 4:3 aspect ratio image is enlarged NON-linearly in horizontal direction to accommodate 16:9 full-screen display. This stretches only the right and left sides of the image; the central part is unchanged.</p>
<p>2. <b>4:3:</b> Scales an image so that it is displayed in the center of the screen with a 4:3 aspect ratio.</p>	<p>5. <b>Real:</b> One-to-one mapping is performed on the input signal without any scaling with the image displayed at the center of the screen.</p>
<p>3. <b>Letter Box:</b> Enlarges an image with letterbox format to display it in full-screen format with a 16:9 aspect ratio. The upper and lower portions of the image are cropped. Use this setting for Cinemascope and Vista video wide screen formats.</p>	

## 3. Other adjustments

You can adjust Brightness, Contrast, Color, and Tint settings in the **Picture** menu or with the remote control.

Some picture adjustments are available only when certain input ports are in use. Unavailable adjustments are not shown on the screen.

## Personalizing the projector menu display

The on-screen display (OSD) menus can be set according to your preferences. These settings will not affect the projection settings, operation, or performance.

- **Language** in **Setup** menu sets your familiar language for the on-screen menus.
- You can select projector's **Background Color** from purple, black or white in **Options** menu.
- **OSD Off (Secs)** in **Options** Menu sets the length of time the OSD will remain active after your last button press.
- **Sleep Timer (Min)** in **Options** menu sets the length of time the projector will auto shutdown.
- **OSD Position H** and **OSD Position V** in **Options** menu adjust the OSD position on the screen.

## Saving and loading the video memory

- Press the video memory buttons on the remote control or **MEMORY ▲** on the projector to recall the settings directly.
- There are four video settings: MEMORY 1, MEMORY 2, MEMORY 3, and DEFAULT. The DEFAULT button can be used to restore the default settings for the current input source.
- For information about saving user memories, refer to page 28.



## Using PIP (Picture-In-Picture) and POP (Picture-On-Picture) functions

There are two groups of inputs classified according to their display modes:

Video Group: Video, and S-Video inputs.

Graphic Group: Component 1 and 2, RGBHD, and HDMI inputs.

The PIP function allows the projector to display one input from the Graphic Group within one input from the Video Group (**G in V**), or display one input from Video Group within one input from the Graphic Group (**V in G**).

The POP function allows the projector to display one input from the Graphic Group and one input from the Video Group side by side (**G <=> V** or **V <=> G**).

If you want to view two images from 2 different input signals at the same time, refer to the following steps to display the second image.

1. Select one input source by pressing one of the Source buttons on the remote control.
2. Press the **PIP** or **POP** button on the remote control.
3. Select the second signal input on the remote control.
4. You may press PIP or POP button repeatedly to choose the corresponding positions (G in V or V in G, G <=> V or V <=> G) of the images.
5. Toggle the **ACTIVE** button on the remote control to switch the active window between the two windows. In the active window, you can change the input signal settings.
6. To adjust the size of the PIP window, press + or -.
7. To adjust the position of the PIP window, press the ARROW buttons (▲/◀/▼/▶).
8. To turn off the PIP or POP function, select **PIP Off** or **POP Off**.

PIP ---

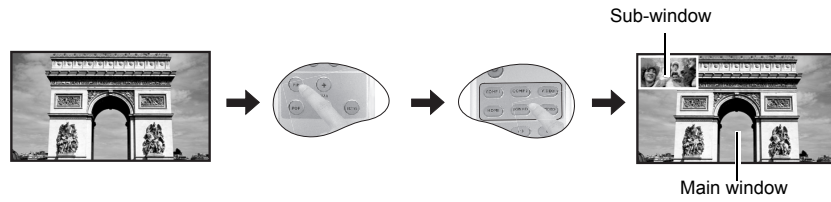

POP ---

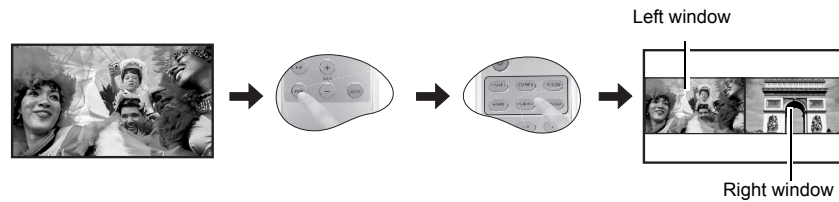

## Turning the power off

Follow the steps below.

1. Press the **POWER** button on the projector or remote control. A confirmation message appears. To turn the projector off, press **POWER** again.
2. The Power indicator light flashes green and the fans run for about two minutes to cool the lamp. The projector will not respond to any commands until the cooling process is complete.
3. Then, the Power indicator light is a steady orange once the cooling process has finished and fans stop.
4. If the projector will not be used for an extended period, turn the main power switch off and unplug the power cable from the power outlet.



# 6 Menus

## Menu structure

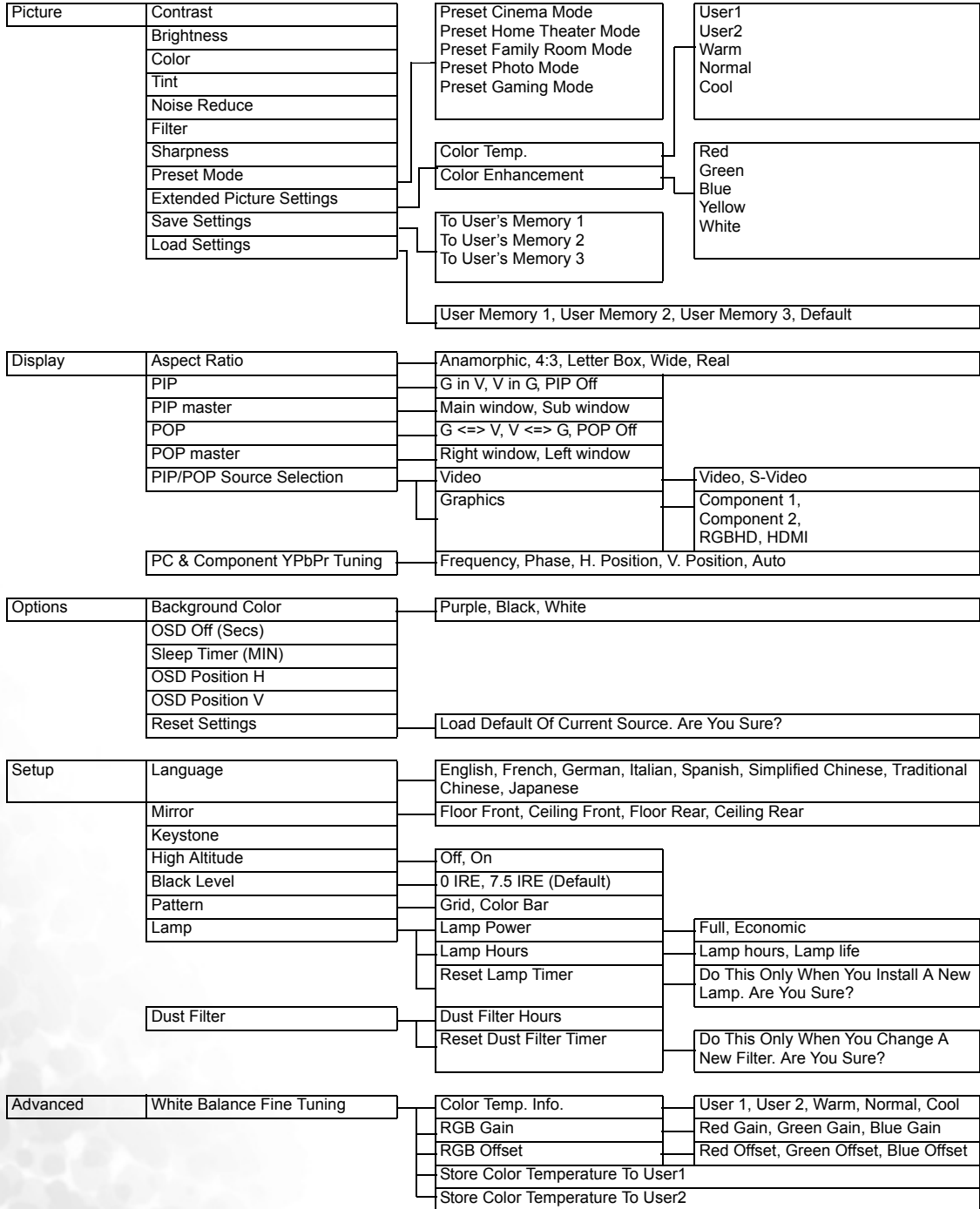



## Using the menus

The projector is equipped with on-screen display (OSD) menus for making various adjustments and settings.

There are eight different menu languages. Refer to Setup Menu on page 27 for more details.

The following example describes the adjustment of the keystone.



1. Press the **MENU/EXIT** button to turn the on-screen menu on.
4. Adjust keystone values by pressing ◀ or ▶.

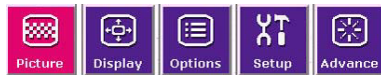

2. Use ◀ or ▶ to select **Setup** and press **SOURCE/ENTER**.

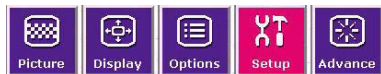

3. Use ▲ or ▼ to select **Keystone**.



5. Press the **MENU/EXIT** button twice\* to leave and save the settings.

\*The first press leads you back to the submenu and the second press closes the on-screen menu.

## Picture menu

The functions provided in this menu allow you to manually adjust the image quality. Before making adjustments, try one of the preset modes in this menu. These modes have preset values for different lighting environment and presentation purposes.

1. **Brightness:** Adjusts the brightness of the image. The higher the value, the brighter the image. And lower the value, the darker the image. Adjust this control so the black areas of the image appear as black and that detail in the dark areas is visible.
2. **Contrast:** Adjusts the degree of difference between dark and light in the image. The higher the value, the greater the contrast.
3. **Color:** Increase or decrease the color intensity of the image. The higher the value, the more vivid and brighter the color.
4. **Tint:** Adjusts the color tones of the image. The higher the value, the more greenish the picture becomes. The lower the value, the more purplish the picture becomes.
5. **Noise Reduce:** Reduces electrical image noise. The higher the setting, the less the noise.



6. **Filter:** Turn the video and data filters on or off. Filters can reduce noise in the picture to produce a sharper image. The higher the setting, the less the noise.
7. **Sharpness:** Adjusts the picture sharpness. The higher the value, the sharper the picture.
8. **Preset Mode:** Preset modes are provided so you can optimize your projector image set-up to suit your program type. Refer to page 21 for more information.
9. **Extended Picture Settings**
  - **Color Temp.:** You can choose a preferred color temperature from among User 1, User 2, Warm, Normal, and Cool. Refer to page 28 for more information about storing the Color Temperature User 1 and 2.
  - **Color Enhancement**
    - Red:** Adjusts red hues independently. The higher the setting, the greater the intensity of red color in the image.
    - Green:** Adjusts green hues independently. The higher the setting, the greater the intensity of green color in the image.
    - Blue:** Adjusts blue hues independently. The higher the setting, the greater the intensity of blue color in the image.
    - Yellow:** Adjusts yellow hues independently. The higher the setting, the greater the intensity of yellow color in the image.
    - White:** Adjusts white peaking.
10. **Save Settings:** There are three video memories in which users can store settings, including all of the items in the **Picture** menu. Each input source can store up to 3 sets of user memories.
  - To store the settings:
    - i.) Adjust the items in the **Picture** menu to your desired values.
    - ii.) Select **Save Settings**, and then press **ENTER**.
    - iii.) Select **To User's Memory 1**, **To User's Memory 2**, or **To User's Memory 3**, and press **ENTER** to store the settings.
    - iv.) To leave the OSD, press **EXIT**.
11. **Load Settings:** Loads the settings from one of three User Memories or the default setting.

## Display menu

Use this menu to set the way that the projector displays the picture.

1. **Aspect Ratio:** There are a few aspect ratios that can be selected for different video signals. For more information, please refer to page 21.
2. **PIP**
  - G in V: Displays one input from the Graphic Group within one input from the Video Group.
  - V in G: Displays one input from the Video Group within one input from the Graphic Group
  - PIP off: Turns the PIP function off.
3. **PIP Master:** Sets the main window or sub-window as the active window in order to make any adjustments for it.
4. **POP**
  - G <=> V: Displays the input from Graphic Group at the left side and Video Group at the right side of the screen.
  - V <=> G: Displays the input from Video Group at the left side and Graphic Group at the right side of the screen.
  - POP Off: Turns the POP function off.
5. **POP Master:** Sets the right window or left window as the active window in order to make any adjustments for it.

6. **PIP/POP Source Selection:** Selects the input signal that will be displayed as the PIP or POP image.

**Video ---**

- Video: Composite video signal.
- S-Video: S-Video video signal.

**Graphics ---**

- Component 1 and 2: Component Y/CB/CR and Y/Pb/PR input
- RGBHD: DTV RGBHD signal input
- HDMI

 **In the unlikely event that the image shakes when PIP or POP function is activated, we suggest you to change the input signals. The shaking image may be caused by the combination of Y/CB/CR and Video, or S-Video.**

7. **PC & Component YPbPr Tuning:** The following settings are only available with a PC or DTV RGB signal selected.

- Frequency: Adjusts the frequency of the sampling clock that captures the input signal.
- Phase: Adjusts the phase of the clock.
- H. Position: Adjusts the horizontal position of the image.
- V. Position: Adjusts the vertical position of the image.
- Auto: Adjusts the phase, and frequency automatically.

## Options menu

In this menu, global settings for the projector can be made.

1. **Background Color:** Allows you to choose the color of the background screen that will be displayed when there is no input signal detected.
2. **OSD Off (Secs):** Sets the length of time the OSD will remain active after your last button press. The range is from 5 to 60 seconds.
3. **Sleep Timer (Min):** Sets the auto-shutdown timer. The timer can be set to a value between 10 minutes and 3 hours.
4. **OSD Position H:** Adjusts the horizontal position of the OSD.
5. **OSD Position V:** Adjusts the vertical position of the OSD.
6. **Reset Settings:** Returns all settings to the factory preset values.

## Setup menu

This menu contains items necessary for basic image setup.

1. **Language:** Sets the language for the OSD menus.
2. **Mirror:** The projector can be installed on a ceiling or behind a screen, or with one or more mirrors. There are four settings for choice. Contact your dealer for the ceiling mount bracket if you need to install the projector on a ceiling. Refer to page 14 for more information.
3. **Keystone:** Corrects for trapezoidal distortion resulting from the angle of projection. It can provide correction of up to  $\pm 12$  degrees.
4. **High Altitude:** This item is designed for those who use the projector in extreme environments, like high temperature or high altitude. We recommend you select **Yes** when your environment is higher than 3000 feet, or is hotter than 40°C.

Operation with **Yes** selected may caused a higher decibel operating noise level because of increased fan speed necessary to improve over-all cooling system and performance.

If you use the projector under other extreme environments excluding the above, it may display auto shut-down symptoms, which is designed to protect your projector from over-heating. In cases like this, you

should switch to **Yes** to solve these symptoms. However, this is not to state that this projector can operate under any and all harsh and extreme environments.

5. **Black level:** The grayscale video signal is measured in IRE units. In some areas which use NTSC TV standard, the grayscale is measured from 7.5 IRE (black) to 100 IRE (white); however, in other areas which use PAL equipment or Japanese NTSC standard, the grayscale is measured from 0 IRE (black) to 100 IRE (white). We suggest that you check the input source if it is with 0 IRE or 7.5 IRE, then select accordingly.
6. **Pattern:** It will be displayed with the aspect ratio setting made using the **Aspect Ratio** function of the **DISPLAY** menu. Use this pattern when installing the projector, even if there is no input signal. Use it to adjust the image size and the focus.
7. **Lamp**
  - Lamp Power: Sets **Full** or **Economic** as the power type of your projection.
  - Lamp Hours: Shows the total time of the lamp has been used.
  - Reset Lamp Timer: Resets the lamp timer. This should only be done after the lamp has been replaced.
8. **Dust Filter**
  - Dust Filter Hours: Shows the total time of the filter has been used.
  - Rest Dust Filter Timer: Reset the dust filter timer. This should only be done after the filter has been replaced.

## Advanced menu

1. **White Balance Fine Tuning:** Adjusts the white color.
  - Color Temp. Info. : shows the current color temperature.

### \*About color temperatures:

There are many different shades that are considered to be “white” for various purposes. One of the common methods of representing white color is known as the “color temperature”. A white color with a low color temperature appears to be reddish white. A white color with a high color temperature appears to have more blue in it.

- RGB Gain... --- Adjusts the contrast levels of Red, Green, and Blue.
- RGB Offset... --- Adjusts the brightness levels of Red, Green, and Blue.

To store Color Temperature to User 1 and 2:

- i.) Open the **Advanced** menu, select **White Balance Fine Tuning > RGB Gain**, and press **ENTER**.
- ii.) Press **▲** or **▼** to select the item to be changed and then adjust the value with the **◀** or **▶** button.
- iii.) Press **EXIT** to leave and save the settings.
- iv.) Repeat steps ii and iii to set RGB Offset values.
- v.) Select and enter “Store Color Temperature to User 1” or “Store Color Temperature to User 2” to save the settings which are made above.
- vi.) Press **EXIT** to leave and save the settings.

### To make the color temperature higher

Set the value of **Blue Gain** greater, and the value of **Red Gain** smaller.

### To make the color temperature lower

Set the value of **Red Gain** greater, and the value of **Blue Gain** smaller.

## 7 Additional information

### Care of the projector

Your projector needs little maintenance. The only thing you have to do on a regular basis is keep the lens clean. Never remove any parts of the projector except the lamp. Contact your dealer if other parts need replacing.

#### Cleaning the lens

Clean the lens whenever you notice dirt or dust on the surface. Before you attempt to clean the lens, turn the projector off, unplug the power cable, and leave it several minutes to cool completely.

1. Use a canister of compressed air to remove dust. (Available from building hardware or photographic suppliers.)
2. If there is stubborn dirt or smudge marks, use a proper photographic lens brush or moisten a clean soft lens cloth with lens cleaner to gently wipe the lens surface.

**Never touch the lens with your finger or rub the lens with abrasive materials. Even paper towels can damage the lens coating. Only ever use a proper photographic lens brush, cloth, and cleaning solution. Do not attempt to clean the lens whilst the projector is switched on or is still hot from previous use.**

#### Cleaning the projector case

Before you attempt to clean the case, turn the projector off, unplug the power cable, and leave it several minutes to cool completely.

1. To remove dirt or dust, wipe the case with a soft, dry, lint-free cloth.
2. To remove stubborn dirt or stains, moisten a soft cloth with water and a neutral detergent. Then wipe the case.

**Never use wax, alcohol, benzene, thinner or other chemical detergents. These can damage the case.**

#### Cleaning and replacing the dust filter

It is necessary to clean the dust filter periodically. You can go to **Setup> Dust Filter Hours** to check how long the filter has been used. If the filter is not cleaned, it can become clogged with dust and prevent proper ventilation. This can cause overheating and a malfunction of the projector.

In case you fail to clean the filter regularly, the projector will shut down automatically once the filter is seriously clogged with dust and cause over-heating inside of the projector. You will see the message pictured to the right before the power off.

**Please install a new filter.  
The projector will turn off in 1 min.**

To clean the filter,

1. Turn the project off and wait until the fans stop running.
2. Disconnect the projector from any cables.
3. Draw the dust filter grill from the front-right side of the projector.

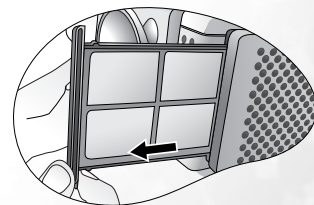

4. Use a small vacuum cleaner designed for computers and other office equipment to clean the filter. Or use a soft brush (such as a clean artist's paintbrush) to gently sweep the dust away.
  - If the dirt is difficult to remove or the filter is broken, contact your place of purchase to replace it.

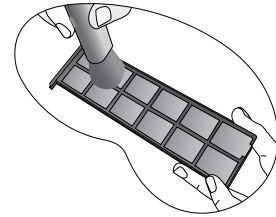

5. Re-install the filter grill securely.
  - If the filter grill is not correctly seated in place, you will be reminded by a message displayed on the screen every three minutes until **MENU/EXIT** on the projector or **EXIT** on the remote control is pressed. The projector will automatically shut down within minutes if there has been no further action taken. Re-install the filters securely, then turn on the power again.
6. Go to **Setup > Reset Dust Filter Timer** to reset the filter timer.

**Please check if the filter is well attached.**

### Storing the projector

If you need to store the projector for an extended time, please:

1. Make sure the temperature and humidity of the storage area are within the recommended range for the projector. Please refer to the Spec. page in this manual or consult your dealer about the range.
2. Retract the adjuster feet.
3. Remove the batteries from the remote control.
4. Pack the projector in its original packing or equivalent.

### Transporting the projector

It is recommended that you ship the projector with its original packing or equivalent. When you carry the projector yourself, please use a soft carry case.

### Replacing the lamp (Contact your BenQ dealer for assistance)

- ⚠ **The lamp may be very hot. Allow the projector to cool for at least 45 minutes before replacing the lamp. This lamp contains mercury. Consult your local hazardous waste regulations to dispose of this lamp in a proper manner.**

1. Turn the power off and disconnect the projector from the wall socket. Turn off all connected equipment and disconnect all other cables.
2. Slightly lift the projector up. Loosen the screws on the lamp cover.

👉 **The lamp door is located at the left side of the projector.**

3. Remove the lamp cover.

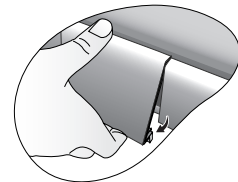
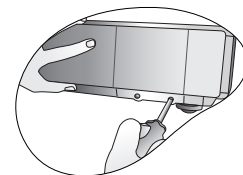

4. Loosen the screws that hold the lamp to the projector. If the screws are not loosened completely, they could injure your fingers. It is strongly recommended that you use a magnetic-head screwdriver to retain the screw should it come loose

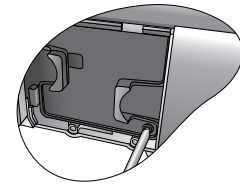

5. Slowly pull the lamp straight out of the projector.

**⚠ Pulling it too quickly may cause the lamp to break and scatter broken glass in the projector. To reduce the risk of injuries to fingers and damage to internal components, use caution when removing lamp glass that has shattered.**

**⚠ Do not place the lamp in locations where water might splash on it, where children can reach it, near or above heat sources, or near flammable materials.**

**⚠ Do not insert your hands into the projector after the lamp is removed. If you touch the optical components inside, it could cause color unevenness and distortion of the projected images.**

6. Insert a new lamp. Make sure it is securely in place.

7. Tighten the screws securing the lamp box.

8. Reinstall the lamp cover.

9. Tighten the screws on the lamp cover.

**⚠ Do not over tighten the screws.**

**⚠ Loose screws may cause a bad connection, which could result in malfunction.**

10. Turn the power on and go into **Setup > Lamp > Reset Lamp Timer** menu to reset the lamp time.

**⚠ Do not turn the power on with the lamp cover removed.**

**⚠ Whenever the lamp is replaced, reset the total lamp operation time.**

**⚠ Do not reset the lamp time if the lamp is not replaced, as this could cause damage.**

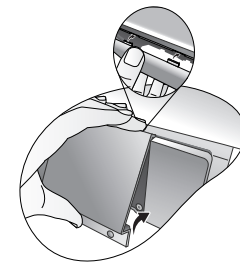
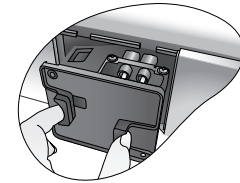

## Indicators

There are three indicators which show the status of the projector. Check the following for information about the indicator lights. If there is anything wrong, turn the projector off and contact your dealer.

### When the projector is in a normal state, ...

POWER	TEMP	LAMP	STATE	REMARK
Orange	Off	Off	Standby mode.	
Flashing orange			The projector is powering up.	Cannot turn the projector off.
Green			The projector is under normal operation.	
Flashing green			(1) The projector needs 110 seconds to cool down as it was abnormally shut down without the normal cooling down process. <b>Or</b> (2) The projector needs to cool for 110 seconds after the power is turned off.	Cannot turn the projector on.

### When the projector is in an abnormal state, ...

POWER	TEMP	LAMP	STATE	REMARK
Orange	Off	Red	(1) The lamp has exceeded its usage life. <b>Or</b> (2) The lamp is not properly attached or is damaged.	Solution: <ul style="list-style-type: none"> <li>• Install a new lamp.</li> <li>• Please contact your dealer for assistance.</li> </ul>
Orange	Red	Off	The dust filter is seriously clogged with dust. The projector is going to shut down.	Solution: <ul style="list-style-type: none"> <li>• Install a new filter.</li> </ul>
Orange	Red	Off	The internal temperature is too high. <ul style="list-style-type: none"> <li>• The intake ventilation or the exhaust ventilation is blocked.</li> <li>• The projector may be in a poorly ventilated location.</li> <li>• The ambient temperature may be too high.</li> </ul>	Solution: <ul style="list-style-type: none"> <li>• Make sure that the ventilation holes are not blocked.</li> <li>• Relocate the projector.</li> <li>• Stop using the projector until the ambient temperature falls within the specified range. The maximum operating temperature is specified as 40°C / 104°F.</li> </ul>
Orange	Flashing red	Flashing red	The fans are not working.	Solution: <ul style="list-style-type: none"> <li>• Check if the power supply is stable.</li> <li>• Check if there is object stuck in the fans.</li> <li>• Contact your dealer.</li> </ul>



## Troubleshooting

Problem	Cause	Remedy
<b>The projector does not turn on.</b>	There is no power from the power cable.	Plug the power cable into the AC inlet on the rear of the projector, and plug the power cable into to a power outlet. If the power outlet has a switch, make sure it is switched on. (Page 19)
	The power switch is not in the on position.	Put the power switch in the on position. (Page 19)
	Attempting to turn the projector on again during the cooling process.	Wait until the cooling down process has completed.
	The lamp cover is not securely attached.	Correctly attach the lamp cover. (Page 30)
<b>No picture.</b>	The video source is not turned on or connected correctly.	Turn the video source on and check that the signal cable is connected correctly. (Page 17)
	The projector is not correctly connected to the input source device.	Check the connection. (Page 17)
	The input signal has not been correctly selected.	Select the correct input signal with the Source buttons on the remote control or <b>SOURCE / ENTER</b> on the projector. (Page 19)
<b>Image is unstable.</b>	The connection cables are not securely connected to the projector or the signal source.	Correctly connect the cables to the appropriate terminals. (Page 17)
<b>Picture is blurred.</b>	The projection lens is not correctly focused.	Adjust the focus of the lens using the focus ring. (Page 20)
	The projector and the screen are not aligned properly.	Adjust the projection angle and direction as well as the height of this unit if necessary. (Page 20)
	The lens cap is still attached to the lens	Remove the lens cap. (Page 19)
<b>Remote control does not work correctly</b>	The batteries are out of power.	Replace both of the batteries with new ones. (Page 10)
	There is an obstacle between the remote control and the projector.	Remove the obstacle. (Page 12)
	You are too far away from the projector.	Stand within 8 meters (26.2 feet) of the projector. (Page 12)

## Specifications

 All specifications are subject to change without notice.

### Optical characteristics

<b>Projection system</b>	Single-chip DLP™ system.
<b>DMD chip</b>	0.8" DMD W_Pal (1280 x 720)
<b>Lens</b>	1.37-times zoom ratio, F/# 2.4 ~ 2.8, f = 24 ~ 32
<b>Projection size</b>	0.94 m to 7.62 m / 37 to 300 inches
<b>Lamp</b>	250W

### Electrical characteristics

<b>Color system</b>	NTSC / PAL-M / PAL-N / PAL 60 / SECAM
<b>Resolution</b>	XGA, SVGA, VGA, Macintosh®, HDTV (1080i, 720p, 576p, 576i, 480p, 480i)
<b>Max. number of display colors</b>	16,770,000 colors (full color display)

### Input

Video, S-Video, Component (Y/ CB/ CR, Y/ PB/ PR)  
RS-232C, RGBHV, HDMI

### General characteristics

<b>Dimensions</b>	380 mm x 300 mm x 115 mm (L x W x H)
<b>Weight</b>	10 lbs / 7.6 kg
<b>Power</b>	VAC 100 - 240V, 4.0 A, 50 / 60 Hz (Automatic)
<b>Power consumption</b>	Max 320 W
<b>Operating temperature</b>	0 °C to 40 °C at sea level
<b>Operating humidity</b>	10% - 90% (without condensation)
<b>Operating altitude</b>	6000 feet at 30°C, 6000 - 10000 feet at max. 23°C
<b>Storage temperature</b>	-10°C- 60°C / 14°F to 140°F
<b>Storage humidity</b>	10% - 90%

## Dimensions

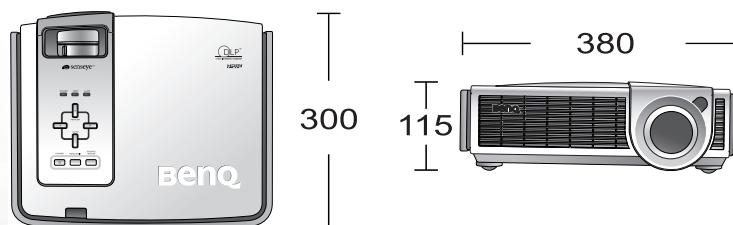

Unit: mm