

BenQ PB6200/ PB6100
Digital Projector
User's Manual

Welcome

Copyright

Copyright 2003 by BENQ Corporation. All rights reserved. No part of this publication may be reproduced, transmitted, transcribed, stored in a retrieval system or translated into any language or computer language, in any form or by any means, electronic, mechanical, magnetic, optical, chemical, manual or otherwise, without the prior written permission of this company.

Disclaimer

BENQ Corporation makes no representations or warranties, either expressed or implied, with respect to the contents hereof and specifically disclaims any warranties, merchantability or fitness for any particular purpose. Further, BENQ Corporation reserves the right to revise this publication and to make changes from time to time in the contents hereof without obligation of this company to notify any person of such revision or changes.







*Windows, Internet Explorer and Outlook Express are trademarks of Microsoft Corporation. Others are copyrights of their respective companies or organizations.

Table of Contents

Important Safety Instructions	1
Introduction	4
Projector Features	4
Shipping Contents	5
Alternative Accessories	5
Optional Accessories	5
Projector Description	6
Your Projector at a Glance	6
External Control Panel	7
Adjuster	8
Remote Control Description	9
Your Remote Control at a Glance	9
Remote Control Effective Range	9
Remote Control Functions	9
Installing or Replacing Batteries	10
Installation	11
Screen Size	11
Connecting to Various Equipment	13
HDTV Equipment	13
Connecting to Various Equipment	14
Operation	15
Start Up	15
Digital Keystone Correction	16
Auto Adjustment	16
Source Selection	16
Blank	17
Menu System	18
1. Display Menu	19
2. Image Menu	20
3. Source Menu	21
4. Control Menu	22
5. PIP Menu	23
Shutdown	24

Maintenance	25
Lamp Information	25
Use and Replacement of the Lamp	25
Lamp Replacement	25
Resetting Lamp Hours	27
Temp Information	27
LED Indicator Status & Illustration	28
Service Information	30
Accessories (included in the standard package)	30
Alternative Accessories (vary from country to country)	30
Optional Accessories (not included in the standard package)	30
Ordering Parts or Getting Information	30
Troubleshooting	31
Common Problems & Solutions	31
Status Messages	32
Specifications	33
Projector Specifications	33
Technical Specifications	33
Timing Chart	34
Dimensions	35
Warranty	36
Limited Warranty	36
Safety Regulations	37
FCC Statement	37
EEC Statement	37
MIC Statement	37

1 Important Safety Instructions

Caution	
<ul style="list-style-type: none">To prevent shock, do not open the cabinet. No user-serviceable parts inside.  <ul style="list-style-type: none">Please read this user's manual before you operate your projector. Save this user's manual for future reference.  <ul style="list-style-type: none">Do not look straight at the projector lens during operation. The intense light beam may damage your eyes. 	<ul style="list-style-type: none">Refer servicing to qualified service personnel.  <ul style="list-style-type: none">Always open the lens shutter or remove the lens cap when the projector lamp is on.  <ul style="list-style-type: none">In some countries, the line voltage is NOT stable. This projector is designed to operate safely within a bandwidth of 100 to 240 volts, but could fail if power cuts or surges of ± 10 volts occur. In these high-risk areas, it is recommended to install a power stabilizer unit. 

Safety Instructions

1. The lamp becomes extremely hot during operation. Allow the projector to cool for approximately 45 minutes prior to removing the lamp assembly for replacement.



2. Do not operate lamps beyond the rated lamp life. Excessive operation of lamps beyond the rated life could cause them to explode on rare occasions.



3. Never replace lamp assembly or any electronic components unless the projector is unplugged.



4. Do not place this product on an unstable cart, stand, or table. The product may fall, sustaining serious damage.



5. To reduce the risk of electric shock, do not disassemble this appliance.



*Take it to a qualified technician when service or repair is required. Incorrect reassembly can cause electric shock when the appliance is subsequently used.

6. This product is capable of displaying inverted images for ceiling mount installation. Please use BenQ's Ceiling Mounting Kit for mounting the unit and ensure it is securely installed.



Safety Instructions (Continued)

7. Do not block the ventilation holes.
- Do not place this unit on a blanket or other bedding.
 - Do not cover this unit with a cloth.
 - Do not place any inflammables near the ventilation holes.

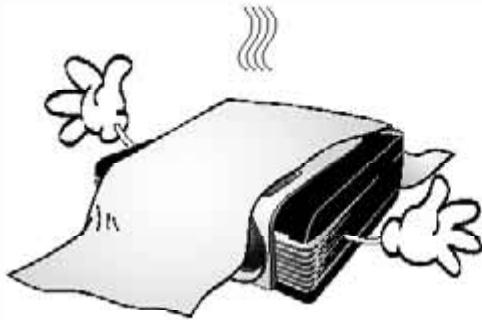

If the ventilation holes are seriously obstructed, overheating inside the unit may result in a fire.

8. Do not place this unit in any of the following environments.
- Space where is poorly ventilated or confined. Allow at least 50 cm clearance from walls.
 - Locations where temperatures may become excessively high, such as the inside of a car with all windows rolled up.
 - Locations where excessive humidity, dust, or cigarette smoke may contaminate optical components, shortening the projector's lifespan and darkening the screen.
 - Locations near fire alarms

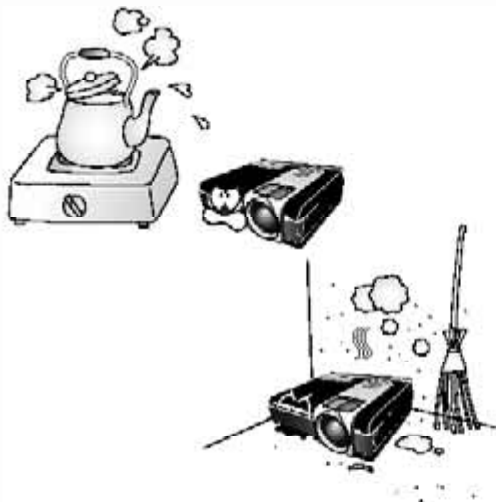

9. Always place the unit on a level, horizontal surface during operation.
- Do not use if tilted at an angle of more than 10 degrees left to right, nor at angle of more than 15 degrees front to back. Using the unit when it is not fully horizontal may cause a malfunction of, or damage to, the lamp.



10. Do not stand the unit on end vertically.

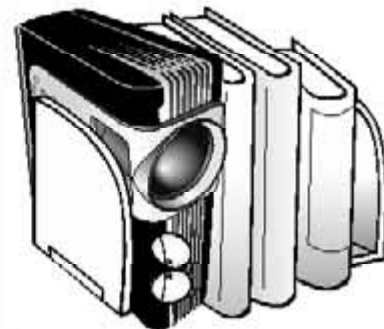

Doing so may cause the unit to fall over, causing injury or resulting in damage to the unit.

11. Do not step on this unit or place any objects upon it.



Besides probable physical damage to the unit, doing so may result in accidents and possible injury.

2 Introduction

Projector Features

The projector integrates high-performance optical engine projection and a user-friendly design to deliver high reliability and ease of use.

The projector offers the following features:

- Small and light for portability
- High quality manual zoom lens
- One-key auto-adjustment to display the best picture quality
- Digital keystone correction to correct distorted images
- Adjustable color balance control for data/video display
- Ultra-high brightness projection lamp
- Ability to display 16.7 million colors
- On-screen menus in 8 languages: English, French, German, Italian, Spanish, Korean, Traditional Chinese and Simplified Chinese.
- 4 preset modes for each signal input allow the projected images optimized.
- Switchable Economic mode to adjust the power consumption
- Powerful AV function to provide high quality AV picture
- HDTV compatibility (YPbPr)

 **Note: The brightness of the projected image will vary depending on the ambient lighting conditions and contrast / brightness settings.**

Shipping Contents

The projector is shipped with the cables required for connection to standard PC or laptop computers. Carefully unpack and verify that you have all the items shown below. If any of these items are missing, please contact personnel at the place of purchase.



Projector



User's Manual



Warranty Booklet



Remote Control



User's Manual CD



Batteries



S-Video Cable



Video Cable



VGA Cable

Alternative Accessories

1. Power Cord: 110V for the US, 240V for UK and 220V for European countries
2. 3-2 converter: For the US



EU



UK



US

Power cord 110V and
3-2 converter

Power cord 220V

Power cord 240V

Optional Accessories

1. Macintosh adapter
2. 200W lamp module
3. Ceiling mount kit
4. HDTV cable
5. Soft carry case

Projector Description

Your Projector at a Glance

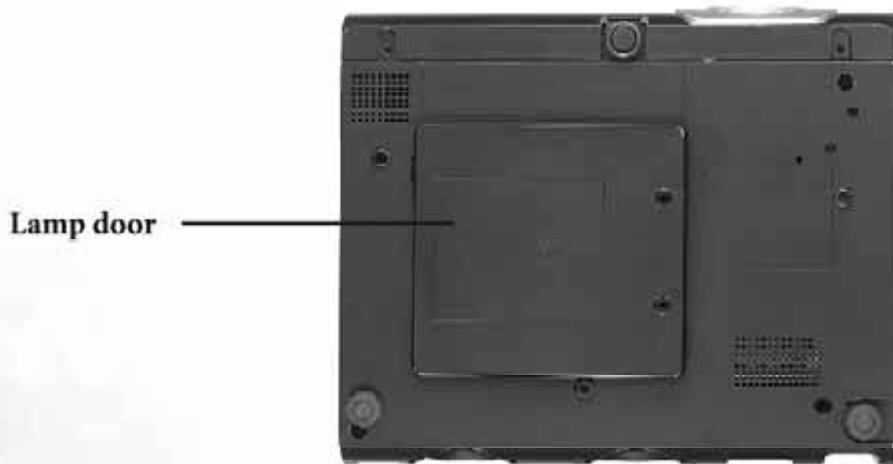
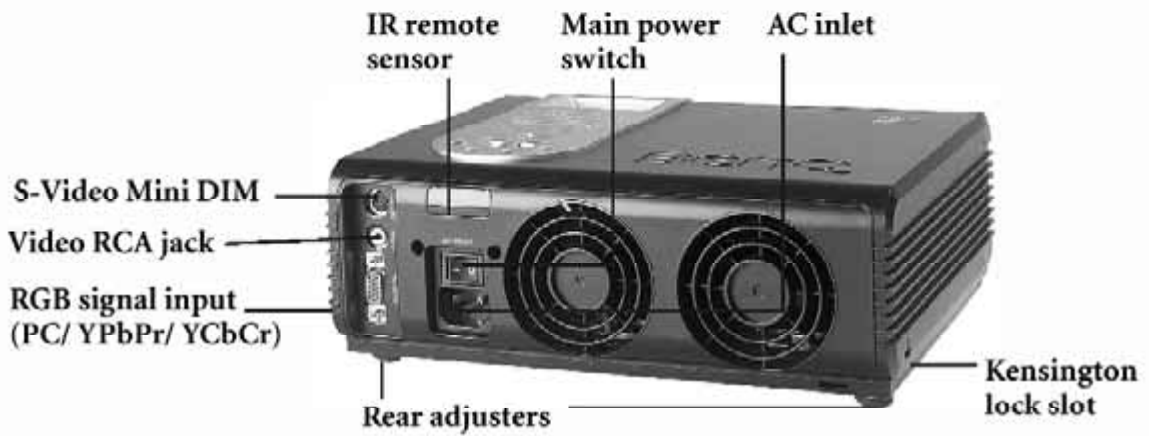

External Control Panel



❶ Power

Presses the Power key to turn the projector on or off.

❷ Source

Selects signal sources from among PC, YPbPr, S-Video and Video.

❸ Left ❹ Exit ❺ Right ❻ Menu

Menu will display the menu system on screen. Press Menu again to access the sub-menus. Left and Right help you navigate among choices and settings in the menus and sub-menus. However, when the on-screen menu is not activated, the Left and Right buttons will function as Keystone -/+ hot keys.

Press the Exit button to go back to the main menu. Press Exit again to leave the menu system.

❼ Auto

Automatically determines the best picture settings for current received signals.

❽ Blank

Uses Blank to hide the screen image. To unseal the image, press Blank again to turn on the image immediately.

❾ Power indicator

It will light up or flash when the projector is under operation.

❿ Temp indicator

The Temp indicator will flash when the system temperature is too high, which may occur if the projector is operated improperly. See "Temp Information" on page 27 for more detailed information.

⓫ Lamp indicator

The Lamp Indicator will light up when the lamp needs service or replacement. See "Lamp Information" on page 25 for more detailed information.

Adjuster

The projector is equipped with 1 quick-release adjuster foot. Push the button to adjust its tilt angle.

1. Lift the projector up and press the adjuster button to release the front adjuster.
2. The adjuster will drop into position and be locked
3. If the projected image is higher than the screen, you can screw the 2 rear adjusters to decrease the offset.

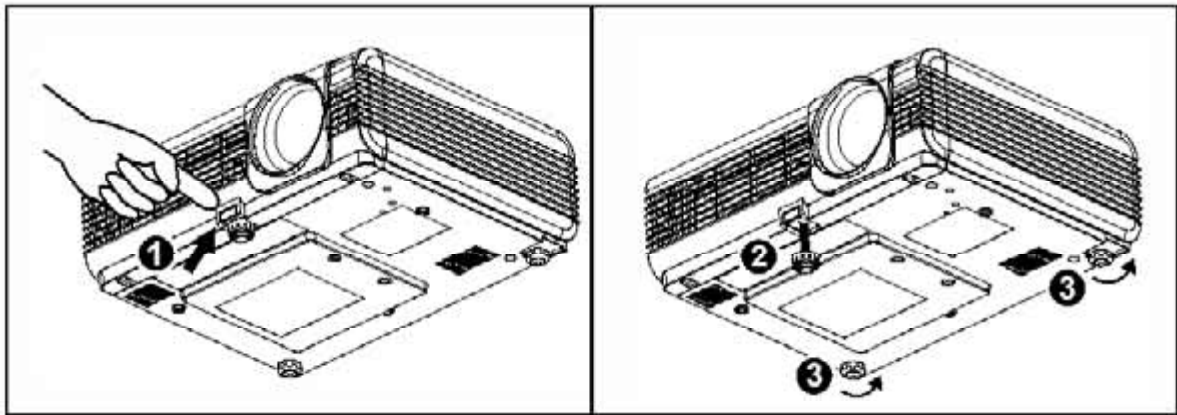

Remote Control Description

Your Remote Control at a Glance

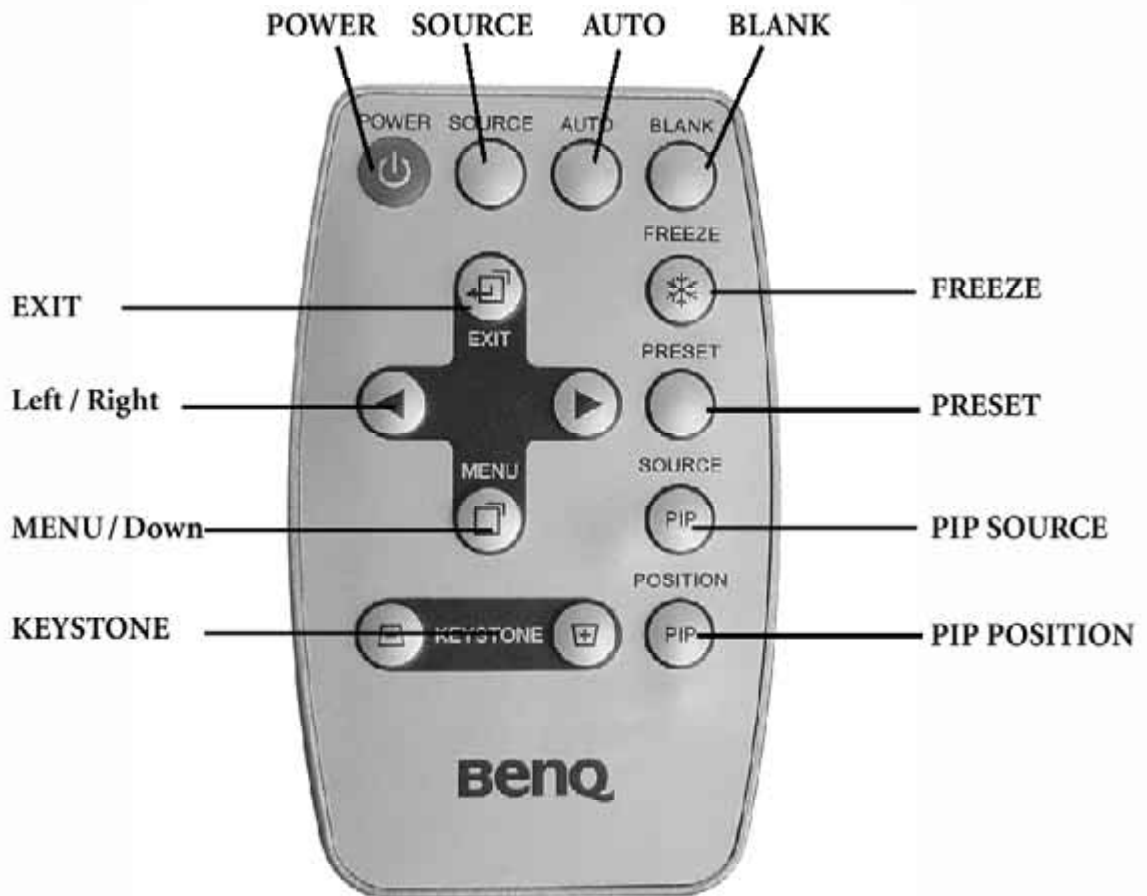

Remote Control Effective Range

The remote sensors are located on the front and the back of the projector. It can function in a range of 30 degrees horizontally and 30 degrees vertically relative to a line that is a right angle to the remote sensors. The distance between the remote control and the remote sensors must be shorter than 6 meters (19.5 feet).

Remote Control Functions

1. POWER, SOURCE, AUTO, BLANK, ◀, ▶, EXIT, MENU

The functions of these buttons are the same as those on the external control panel. Please refer to "External Control Panel" on page 7 for more information.

2. KEYSTONE

If the image is trapezoid after adjusting the projection offset, press KEYSTONE + OR KEYSTONE - to correct distorted image.

3. FREEZE

The image can be frozen when FREEZE is pressed. An icon  will appear in the lower right corner of the screen. To release the freeze function, press the FREEZE button again.

4. PRESET

Users can switch 4 kinds of preset modes. The preset mode changes each time when you press PRESET button

- PC Signal:
Presentation Mode (Default) --> Vivid Mode --> Video Mode --> Economic Mode
- YPbPr/ S-Video/ Video Signal:
Gaming Mode (Default) --> Video Mode --> Cinema Mode --> Economic Mode

5. PIP SOURCE

User can activate PIP and select the source between S-Video and Video while the input source is PC. The PIP source changes in the order of S-Video, Video, and off.

6. PIP POSITION

While PIP is activated, you can select one of the nine positions.

Installing or Replacing Batteries

1. Use a pointy-sided stick to release the battery tray. Pull the tray off.

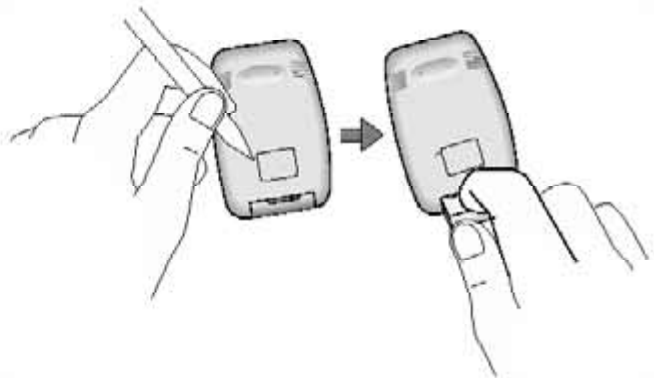

2. Install or replace a battery.



3. Snap the battery tray back into place.

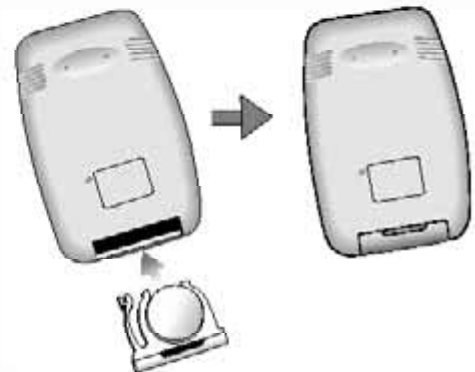

 **Avoid excessive heat and humidity. There may be danger of an explosion if batteries are incorrectly replaced. Replace only with the same or equivalent type recommended by the manufacturer. Dispose of used batteries according to the manufacturer's instructions.**

3 Installation

Screen Size

Place the projector at the required distance from the screen according to the desired picture size (see the table below).

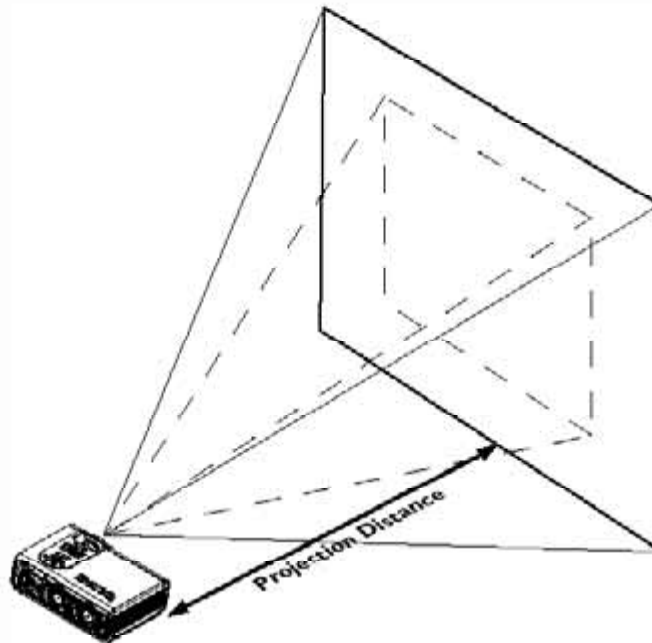

PB6200 (XGA) screen size chart (4:3 aspect ratio)

Distance from screen		Diagonal measurement				Distance from screen		Diagonal measurement			
		Minimum zoom		Maximum zoom				Minimum zoom		Maximum zoom	
feet	inches	feet	inches	feet	inches	meters	cm	meters	cm	meters	cm
4	48	2.49	29.9	3.05	36.6	1	100	0.62	62.2	0.76	76.2
6	72	3.73	44.8	4.57	54.9	1.5	150	0.93	93.3	1.14	114.3
8	96	4.98	59.7	6.10	73.2	2	200	1.24	124.5	1.52	152.4
10	120	6.22	74.7	7.62	91.4	2.5	250	1.56	155.6	1.91	190.5
12	144	7.47	89.6	9.14	109.7	3	300	1.87	186.7	2.29	228.6
14	168	8.71	104.5	10.67	128.0	3.5	350	2.18	217.8	2.67	266.7
16	192	9.96	119.5	12.19	146.3	4	400	2.49	248.9	3.05	304.8
18	216	11.20	134.4	13.72	164.6	4.5	450	2.80	280.0	3.43	342.9
20	240	12.45	149.4	15.24	182.9	5	500	3.11	311.2	3.81	381.0
22	264	13.69	164.3	16.76	201.2	5.5	550	3.42	342.3	4.19	419.1
24	288	14.94	179.2	18.29	219.5	6	600	3.73	373.4	4.57	457.2
26	312	16.18	194.2	19.81	237.7	6.5	650	4.04	404.5	4.95	495.3
28	336	17.42	209.1	21.34	256.0	7	700	4.36	435.6	5.33	533.4
30	360	18.67	224.0	22.86	274.3	7.5	750	4.67	466.7	5.72	571.5
32	384	19.91	239.0	24.38	292.6	8	800	4.98	497.8	6.10	609.6

PB6200 (XGA) screen size chart (16:9 aspect ratio)

Distance from screen		Diagonal measurement			
		Minimum zoom		Maximum zoom	
feet	inches	feet	inches	feet	inches
4	48	2.29	27.5	2.80	33.6
6	72	3.44	41.3	4.20	50.4
8	96	4.59	55.1	5.60	67.2
10	120	5.74	68.8	7.00	84.0
12	144	6.88	82.6	8.40	100.8
14	168	8.03	96.4	9.80	117.6
16	192	9.18	110.1	11.20	134.4
18	216	10.32	123.9	12.60	151.2
20	240	11.47	137.7	14.00	167.9
22	264	12.62	151.4	15.39	184.7
24	288	13.77	165.2	16.79	201.5
26	312	14.91	179.0	18.19	218.3
28	336	16.06	192.7	19.59	235.1
30	360	17.21	206.5	20.99	251.9
32	384	18.35	220.3	22.39	268.7

Distance from screen		Diagonal measurement			
		Minimum zoom		Maximum zoom	
meters	cm	meters	cm	meters	cm
1	100	0.57	57.4	0.70	70.0
1.5	150	0.86	86.0	1.05	105.0
2	200	1.15	114.7	1.40	140.0
2.5	250	1.43	143.4	1.75	179.4
3	300	1.72	172.1	2.10	209.9
3.5	350	2.01	200.8	2.45	244.9
4	400	2.29	229.4	2.80	279.9
4.5	450	2.58	258.1	3.15	314.9
5	500	2.87	286.8	3.50	349.9
5.5	550	3.15	315.5	3.85	384.9
6	600	3.44	344.1	4.20	419.9
6.5	650	3.37	372.8	4.55	454.9
7	700	4.02	401.5	4.90	489.8
7.5	750	4.30	430.2	5.25	524.8
8	800	4.59	458.9	5.60	559.8

PB6100 (SVGA) screen size chart (4:3 aspect ratio)

Distance from screen		Diagonal measurement			
		Minimum zoom		Maximum zoom	
feet	inches	feet	inches	feet	inches
4	48	1.96	23.5	2.40	28.7
6	72	2.93	35.2	3.59	43.1
8	96	3.91	47.0	4.79	57.5
10	120	4.89	58.7	5.99	71.9
12	144	5.87	70.4	7.19	86.2
14	168	6.85	82.2	8.39	100.6
16	192	7.83	93.9	9.58	115.0
18	216	8.80	105.7	10.78	129.4
20	240	9.78	117.4	11.98	143.7
22	264	10.76	129.1	13.18	158.1
24	288	11.74	140.9	14.37	172.5
26	312	12.72	152.6	15.57	186.9
28	336	13.70	164.3	16.77	201.2
30	360	14.67	176.1	17.97	215.6
32	384	15.65	187.8	19.17	230.0

Distance from screen		Diagonal measurement			
		Minimum zoom		Maximum zoom	
meters	cm	meters	cm	meters	cm
1	100	0.49	48.9	0.60	59.9
1.5	150	0.73	73.4	0.90	89.8
2	200	0.98	97.8	1.20	119.8
2.5	250	1.22	122.3	1.50	149.7
3	300	1.47	146.7	1.80	179.7
3.5	350	1.71	171.2	2.10	209.6
4	400	1.96	195.7	2.40	239.6
4.5	450	2.20	220.1	2.70	269.5
5	500	2.45	244.6	2.99	299.5
5.5	550	2.69	269.0	3.29	329.4
6	600	2.93	293.5	3.59	359.4
6.5	650	3.18	317.9	3.89	389.3
7	700	3.42	342.4	4.19	419.3
7.5	750	3.67	366.8	4.49	449.2
8	800	3.91	391.3	4.79	479.1

PB6100 (SVGA) screen size chart (16:9 aspect ratio)

Distance from screen		Diagonal measurement			
		Minimum zoom		Maximum zoom	
feet	inches	feet	inches	feet	inches
4	48	1.80	21.6	2.20	26.4
6	72	2.70	32.4	4.20	50.4
8	96	3.61	43.3	5.60	67.2
10	120	4.51	54.1	7.00	84.0
12	144	5.41	64.9	8.40	100.8
14	168	6.31	75.7	9.80	117.6
16	192	7.21	86.5	11.20	134.4
18	216	8.11	97.3	12.60	151.2
20	240	9.01	108.2	14.00	167.9
22	264	9.91	119.0	15.39	184.7
24	288	10.82	129.8	16.79	201.5
26	312	11.72	140.6	18.19	218.3
28	336	12.62	151.4	19.59	235.1
30	360	13.52	162.2	20.99	251.9
32	384	14.42	173.1	22.39	268.7

Distance from screen		Diagonal measurement			
		Minimum zoom		Maximum zoom	
meters	cm	meters	cm	meters	cm
1	100	0.45	45.1	0.55	55.0
1.5	150	0.68	67.6	0.82	82.5
2	200	0.90	90.1	1.10	110.0
2.5	250	1.13	112.7	1.37	137.5
3	300	1.35	135.2	1.65	164.9
3.5	350	1.58	157.7	1.92	192.4
4	400	1.80	180.3	2.20	219.9
4.5	450	2.03	202.8	2.47	247.4
5	500	2.25	225.3	2.75	274.9
5.5	550	2.48	247.9	3.02	302.4
6	600	2.70	270.4	3.30	329.9
6.5	650	2.93	292.9	3.57	357.4
7	700	3.15	315.5	3.85	384.9
7.5	750	3.38	338.0	4.12	412.4
8	800	3.61	360.5	4.40	439.8

 There is 3% – 5% tolerance among these numbers due to optical component limits.

* 1m = 3.28 feet, 1 foot = 0.305m, 1m = 100cm, 1 foot = 12 inches

Connecting to Various Equipment

HDTV Equipment

The projector is capable of displaying various High Definition TV display modes. Some of these sources are:

- Digital-VHS (D-VHS) player
- DVD player
- Satellite Dish HDTV receiver
- DTV tuners

Most of these sources will provide an analog component video output, a standard VGA output, or a YPbPr (default) format.

The projector is capable of accepting HDTV data through a D-Sub connector. Use a HDTV cable that is an optional accessory to display HDTV images.

The following standards are supported in the HDTV function:

- 480i
- 480p
- 576i
- 576p
- 720p
- 1080i

Please refer to "Menu System" on page 18 for information on the HDTV OSD selections.

Connecting to Various Equipment

It only takes a few seconds to connect your projector to your desktop or notebook computer, VCR, or other systems. However, a Mac adapter (an optional accessory) is needed for connection to Macintosh computers.

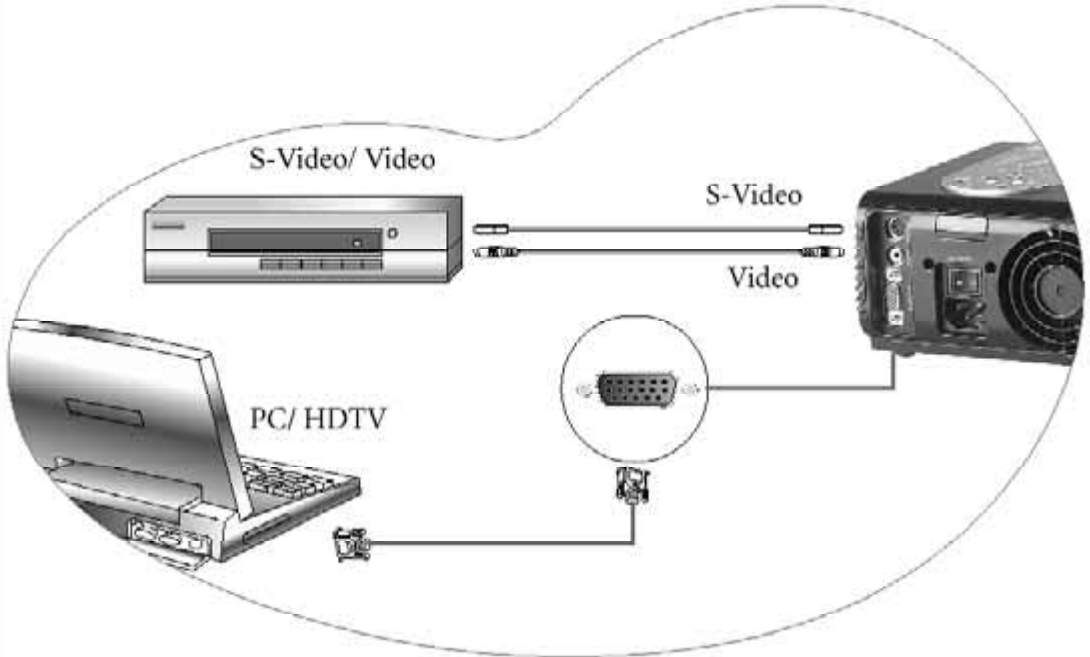

4 Operation

Start Up

1. Plug the power cord into the projector and into a wall socket.

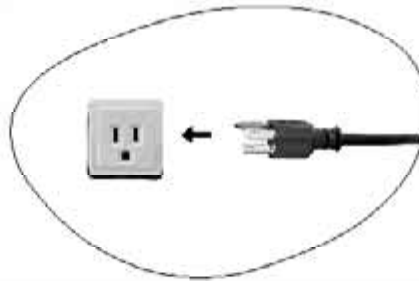

2. Turn on the main power switch.



3. Press and hold POWER for 1 second to start the projector. The back-lit POWER key flashes green and stays green when the power is turned on.



(When the power is turned off, there is a 90-second cooling period before the projector can be re-started.)

4. Switch on all connected equipment.

Digital Keystone Correction

Keystoning refers to the situation where the projected image is noticeably wider at either the top or bottom. To correct this, press **Left/ Right** (hot key) on the control panel of the projector or **KEYSTONE** **← / →** on the remote control, and then adjust the sliding bar labeled **Keystone**, as needed. Press **+** to correct keystone at the top of the image. Press **-** to correct keystone at the bottom of the image.

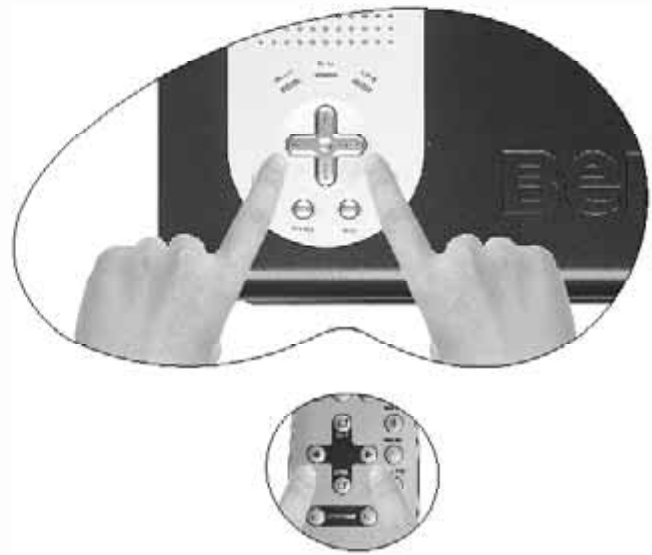

Auto Adjustment

In some cases, you may need to optimize the picture quality. To do this, press the **AUTO** key on the control panel of the projector or on the remote control. Within 3 seconds, the built-in Intelligent Auto Adjustment function will re-adjust settings to provide the best picture quality.



Source Selection

When several input sources are available, press the **SOURCE** key to make a selection from the control panel of the projector or the remote control.





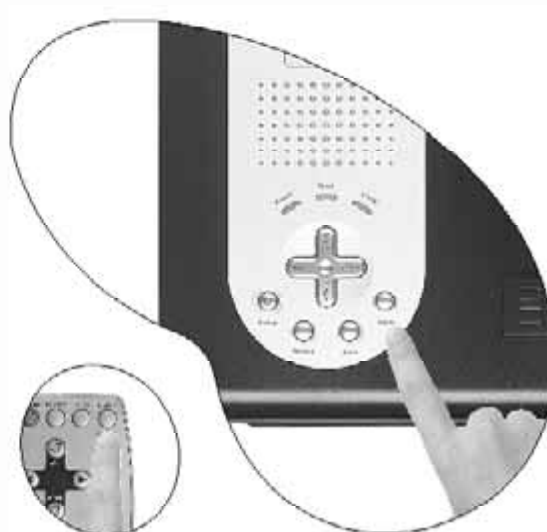

Blank

Uses **Blank** to hide the screen image. You can unseal the image gradually by using the mouse of the remote control, or simply press **Blank** to turn on the image immediately.







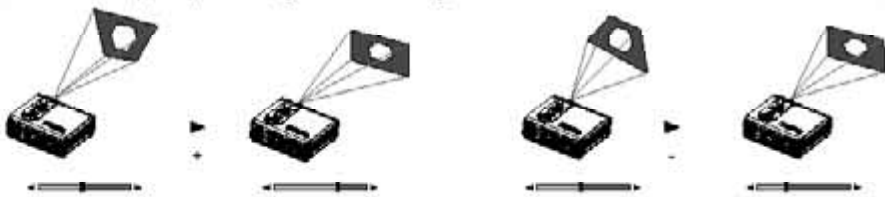
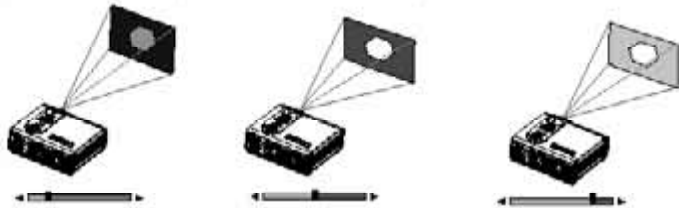
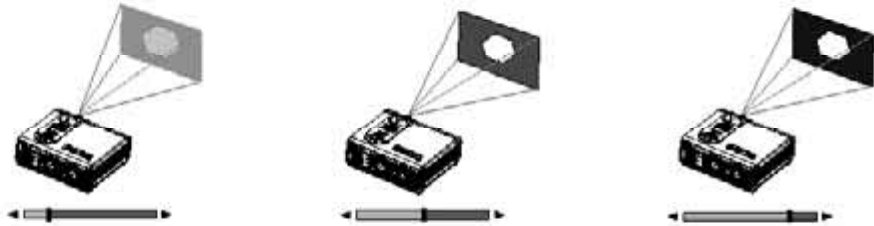

Menu System

Press Menu for the main menu, and then press ◀ or ▶ to select a sub-menu. Press Menu again to select items in the sub-menu.

Functions available when connecting to different equipment...			
Sub-Menu	PC	Y/Pb/Pr	S-Video / Video
 Display	Keystone Brightness Contrast Phase H Size		Keystone Brightness Contrast Color Tint
 Image	Aspect Ratio H Position V Position Color Temp Information	Aspect Ratio Color Tint Color Temp	Aspect Ratio System Sharpness Color Temp Information
 Source	Mirror Source Source Scan Blank Time Auto Off		
 Control	Language OSD Pos. OSD Time Preset Mode Reset Lamp Hour		
 PIP	Main Page: PIP Source PIP Size PIP Pos. H Position V Position More Options	Sub Page: Brightness Contrast Color Tint Sharpness	

1. Display Menu

FUNCTION	DESCRIPTION
Keystone	Corrects any keystone of the image. 
Brightness	Adjusts the brightness of the image. 
Contrast	Adjusts the degree of difference between dark and light in the image. 
Phase	Adjusts to avoid the occurrence of flicker.   This function is not available when the input mode is Video or S-Video.
H Size	Adjusts to fit in the desired image size.  This function is not available when the input mode is Video or S-Video.
Color	Increases or decreases the color range (R, G, B) of the image.  This function is not available when the input mode is PC.
Tint	Adjusts the image to make it appear more red or blue.  This function is not available when the input mode is PC.

2. Image Menu

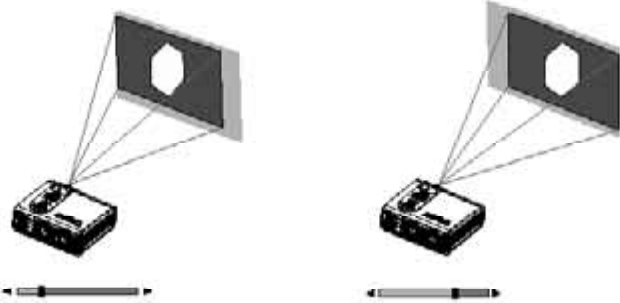
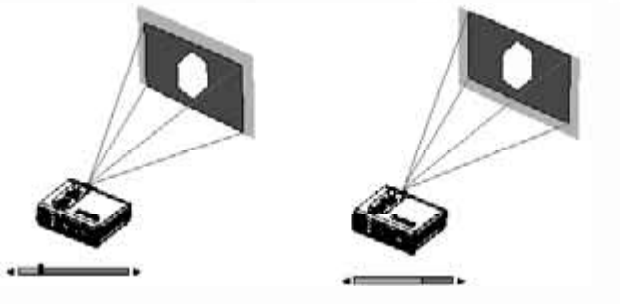
FUNCTION	DESCRIPTION
Aspect Ratio	Makes the best fit of the image to the screen, 1. 4 : 3 2. 16 : 9 3. Native
H Position	<input type="checkbox"/> "Native" is available only when the input mode is PC . Adjusts the horizontal position of the projected image.
	
V Position	<input type="checkbox"/> This function is available only when the input mode is PC. Adjusts the vertical position of the projected image.
	
Color Temp	<input type="checkbox"/> This function is available only when the input mode is PC. Adjusts the color temperature to fit your preference.
Information	Shows the current resolution and preset mode.
System	System information will be shown: 1. NTSC 2. PAL 3. SECAM 4. YUV
Sharpness	Adjusts the image to make it look sharper or softer. <input type="checkbox"/> This function is not available when the input mode is PC or YPbPr.
Color	Increases or decreases the color range (R, G, B) of the image. <input type="checkbox"/> This function is not available when the input mode is PC.
Tint	Adjusts the image to make it appear more red or blue. <input type="checkbox"/> This function is available only when the selected System is NTSC.

3. Source Menu

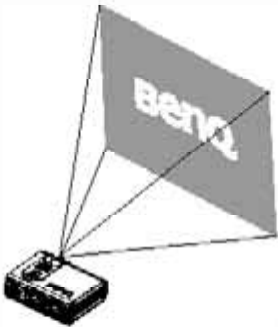
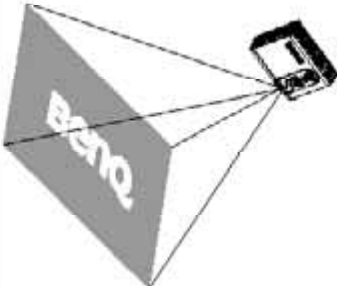
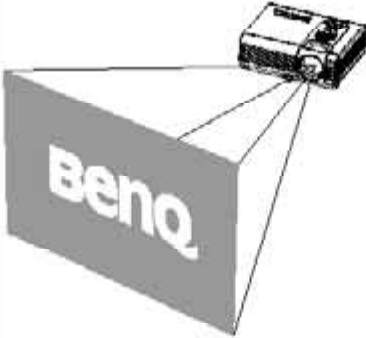
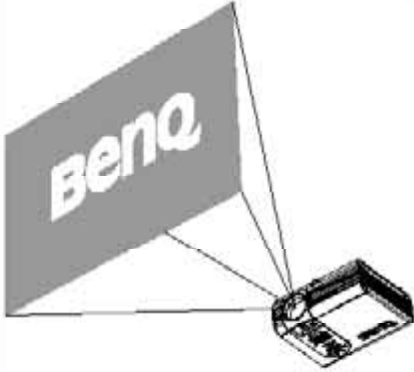
FUNCTION	DESCRIPTION	
Mirror	1. Default	2. Ceiling mounted projection
		
	3. Rear screen projection	4. Ceiling mounted and rear-screen projection
		
Source	Shows the selected input source among PC, YPbPr, S-Video and Video when they are available.	
Source Scan	If selecting ON, the function is activated and the projector starts to scan in order of PC, YPbPr, S-Video and Video when there is no signal detected. If selection OFF, the projector only detects the last input source.	
Blank Time	Determines the length of time before the projector is shut off when Blank is activated.	
Auto Off	Sets the length of time before the system is shut off when no input is detected.	

4. Control Menu

FUNCTION	DESCRIPTION
Language	Language sets the language for the OSD control menus. Use the ◀ / ▶ key to select the desired language from among English, French, German, Italian, Spanish, Korean, Traditional Chinese and Simplified Chinese.
OSD Pos.	Selects a desired OSD position.
OSD Time	Sets the length of time the OSD will remain active after the last time you pressed the button. The range is from 5 to 60 seconds in 5-second increments.
Preset Mode	To optimize the projected images, you are free to choose one of the preset modes in accordance to the purpose of projection. PC Signal <ol style="list-style-type: none">Presentation Mode: It is designed for presentations. The brightness is emphasized in this mode.Vivid Mode: It is perfect for gaming. The color saturation and brightness are well-balanced.Video Mode: It is suitable for cinematic enjoyment in their natural color.Economic Mode: With lower system noise, the lamp can save 20% power to extend its life. YPbPr/ S-Video/ Video Signal <ol style="list-style-type: none">Gaming Mode: It is suitable for playing video games in a bright living room.Video Mode: With a higher color temperature, it is suitable for enjoying movies.Cinema Mode: With a lower color temperature, it is suitable for enjoying movies.Economic Mode: With lower system noise, the lamp can save 20% power to extend its life.
Reset	Returns all settings to their factory preset values.
Lamp Hour	Shows lamp usage time.

5. PIP Menu

These functions are available only when the input mode is PC and the PIP source is Video or S-Video.

FUNCTION	DESCRIPTION
PIP Source	Selects the source for the PIP.
PIP Size	Enables use of the ◀ / ▶ key to scroll through the four alternatives: Off, Small, Medium, Large.
PIP Position	Selects a desired position for the PIP.
H Position	Adjusts the horizontal position of the PIP image.
V Position	Adjusts the vertical position of the PIP image.
More Options	Enables use of the ◀ / ▶ key to select more PIP functions including Brightness, Contrast, Color, Tint, Sharpness and System.
Brightness	Adjusts the brightness of the PIP image.
Contrast	Adjusts the degree of difference between dark and light for the PIP image.
Color	Increases or decreases the color range (R, G, B) of the image.
Tint	Adjusts the image to make it appear more red or blue.
Sharpness	Adjusts the image to make it appear sharper or softer

Shutdown

1. Press and hold **POWER** and a warning message will appear. To turn off the projector, press and hold **POWER** again.

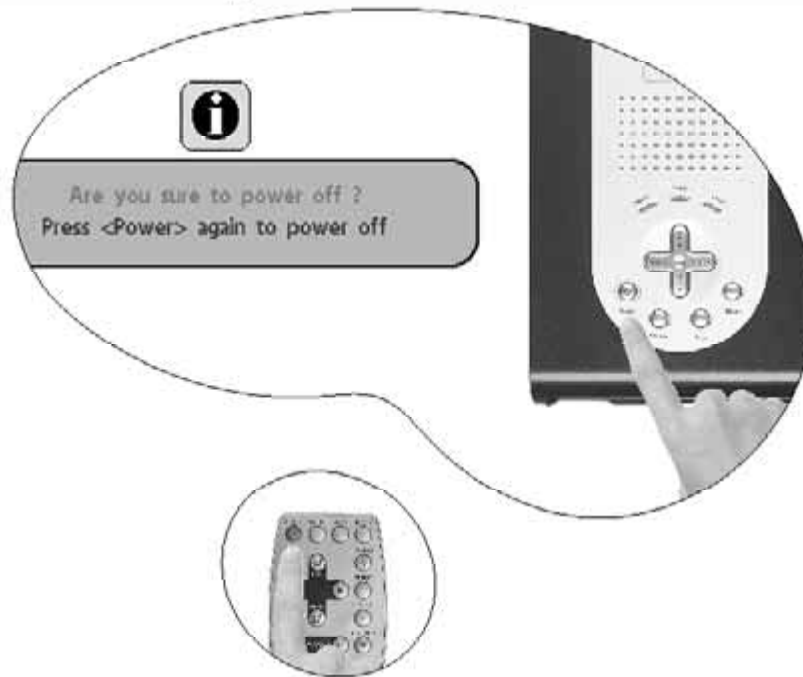

2. The fan will continue to run for approximately 90 seconds.
3. Turn off the main power switch.



4. Disconnect the power cord from the wall socket.

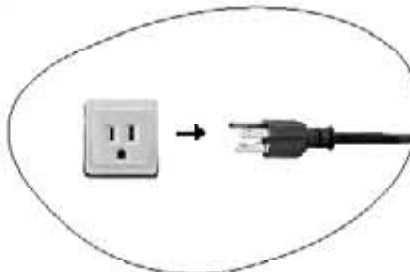

⚠ Do not unplug the power cord before **POWER is shut down or during the 90-second cooling process.**
If the projector is not properly shut down, to protect the lamp, the system will detect this and cool the lamp for 90 seconds automatically before turning on again.

5 Maintenance

Lamp Information

Use and Replacement of the Lamp

When the Lamp Indicator lights up red or a message appears suggesting the time of lamp replacement, please install a new lamp or consult your dealer. An old lamp could cause a malfunction in the projector and in rare instances may even break.

For more detailed information, please refer to "LED Indicator Status & Illustration" on page 28.

-  **The Lamp and Temp indicators will light up if the lamp becomes too hot. Turn off the power and let the projector cool for 45 minutes. If the Lamp or Temp indicator still lights up when turning the power on, please contact your dealer.**

Lamp Replacement

-  **To reduce the risk of electrical shock, always turn off the projector and disconnect the power cord before changing the lamp.**

To reduce the risk of severe burns, allow the projector to cool for at least 45 minutes before replacing the lamp.

To reduce the risk of injuries to fingers and damage to internal components, use caution when removing lamp glass that has shattered into sharp pieces.

To reduce the risk of injuries to fingers and/or compromising image quality by touching the lens, do not touch the empty lamp compartment when the lamp is removed.

This lamp contains mercury. Consult your local hazardous waste regulations to dispose of this lamp in a proper manner.

- Step 1. Turn off the projector. Disconnect the power cord from the outlet and the projector.
- Step 2. Loosen the screw and remove the lamp cover. (It is strongly recommended that you use a magnetic-head screwdriver.) If the lamp is hot, avoid burns by waiting 45 minutes until the lamp has cooled.

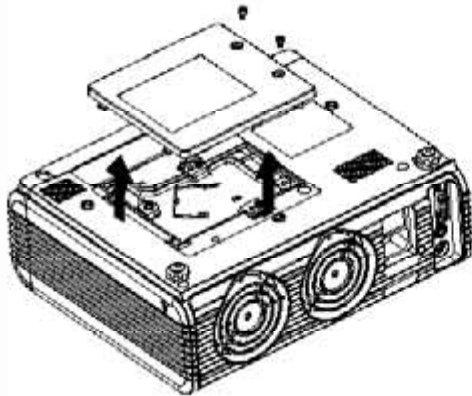

- Step 3. Loosen the 3 screws. Pull the handle to remove the lamp housing. If the screws are not loosened completely, they could injure your fingers. Do not insert your hand into the box after the lamp is removed. If you touch the optical components inside, this could cause color unevenness in projected images.

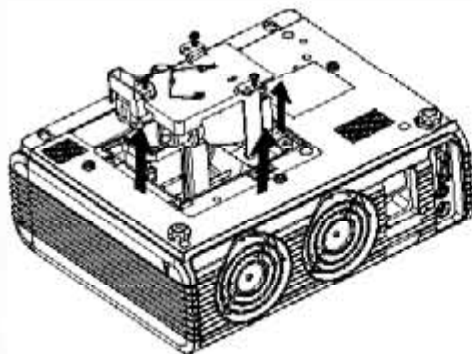

- Step 4. Replace the lamp with a new one. Insert it into the projector, and tighten the screws firmly. Loose screws may cause a bad connection, which may result in malfunction.

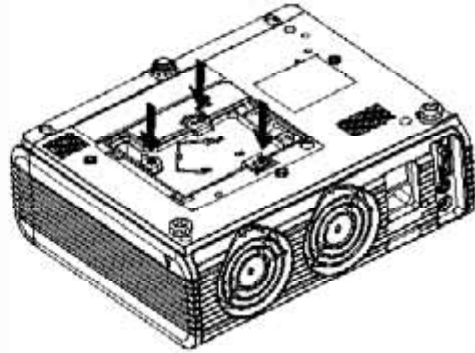

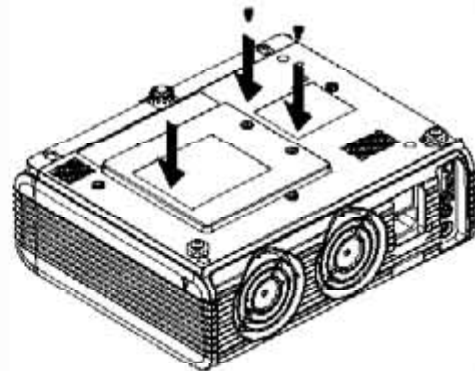

- Step 5. Re-install the lamp cover and tighten the screw. Do not turn on the power with the lamp cover removed. Whenever the lamp is replaced, reset the total lamp operation time. Do not reset if the lamp is not replaced as this could cause damage.



Resetting Lamp Hours

If you replace the lamp with a new one, please follow the instructions below to reset the lamp hour.

OSD	INSTRUCTIONS
	Press and hold the Exit button on the projector for 3 seconds to display the total used lamp time. With the OSD on, press MENU to activate RESET function or press EXIT to leave.
	Press ◀ or ▶ to reset the lamp hour to zero or press EXIT to leave.
	This message displays when the lamp hour is reset to zero. You can press EXIT to leave.

Temp Information

When the LED lights up, it is warning you of the following possible problems:





1. The internal temperature is too high.
2. The fans are not working.











Turn off the projector and contact qualified service personnel for further help.

For more detailed information, please refer to "LED Indicator Status & Illustration" on page 28.

LED Indicator Status & Illustration

Illustration

1. - : LED OFF
2.  : LED blinking
3.  : LED solid ON
4.  : LED lights up orange.
5.  : LED lights up red.
6.  : LED lights up green.

LED			Status & Description
Power	Temp	Lamp	
Power events			
			Power switch on
	-	-	Power-up cooling. Projector cooling system will auto-cool for 90 seconds when power was abnormal shutdown without cooling and power on again within hours.
	-	-	Stand-by
	-	-	Lamp LED is blinking during powering up.
	-	-	Power-down cooling for 90 seconds after power has been turned off.
	-	-	Normal operation
Lamp events			
-	-		Lamp spoil, it is warning you that lamp usage has exceeded 3000 hours. Replace the projection lamp with a new one immediately.
-	-		Lamp error, the lamp is not properly attached or lamp damaged. Please contact your dealer.

Thermal events			
R	R	-	Fan 1 error, projector will auto shutdown. If you return on the power, and projector shutdown again. Please contact your dealer.
R	R	G	Fan 2 error, projector will auto shutdown. If you return on the power, and projector shutdown again. Please contact your dealer.
R	R	G	Fan 3 error, projector will auto shutdown. If you return on the power, and projector shutdown again. Please contact your dealer.
G	R	-	Thermal sensor 1 over-temperature, projector will auto shutdown. If you return on the power, and projector shutdown again. Please contact your dealer.
G	R	G	Thermal sensor 2 over-temperature, projector will auto shutdown. If you return on the power, and projector shutdown again. Please contact your dealer.
G	R	G	Thermal sensor 3 over-temperature, projector will auto shutdown. If you return on the power, and projector shutdown again. Please contact your dealer.
-	R	-	Thermal sensor 1 doesn't work, projector will auto shutdown. If you return on the power, and projector shutdown again. Please contact your dealer.
-	R	G	Thermal sensor 2 doesn't work, projector will auto shutdown. If you return on the power, and projector shutdown again. Please contact your dealer.
-	R	G	Thermal sensor 3 doesn't work, projector will auto shutdown. If you return on the power, and projector shutdown again. Please contact your dealer.

Service Information

Accessories (included in the standard package)

Description of parts	Part Number
VGA cable	50.J0508.503
Video cable	50.J1303.501
S-Video cable	50.72920.011
Remote control	56.26J86.001

Alternative Accessories (vary from country to country)

Description of parts	Part Number
Power cord (US)	27.01818.000
3-2 converter (US)	22.91007.001
Power cord (EU)	27.82718.281
Power cord (UK)	27.01018.000

Optional Accessories (not included in the standard package)

Description of parts	Part number
Mac adapter (switchable)	20.20118.A15
200W lamp module	60.J8618.CG1
Ceiling mount kit	60.J7615.001
Soft carry case	98.J7601.001
HDTV cable	50.J2401.001

Ordering Parts or Getting Information

For product information, product assistance, service information, or to order accessories, please visit the BENQ Corporation website at <http://www.BenQ.com>.

6 Troubleshooting

Common Problems & Solutions

① NO POWER

👉 Try these solutions:

- Make sure the power cord is inserted snugly into the AC adapter socket.
- Make sure the power cord is inserted snugly into the power outlet.
- Toggle the power switch to the position "1".
- Wait 90 seconds after the projector is turned off before turning the projector back on.

① NO PICTURE

👉 Try these solutions:

- Check for the proper input source.
- Ensure all cables are connected properly.
- Adjust the brightness and contrast.
- Remove the lens cap.

① TRAPEZOID IMAGE ON THE SCREEN

👉 Try these solutions:

- Reposition the unit to improve its angle on the screen.
- Use the Keystone correction key on the control panel of the projector or the remote control unit.

① POOR COLOR

👉 Try these solutions:

- Select the correct video system.
- Adjust brightness, contrast, or saturation.

① BLURRED IMAGE

👉 Try these solutions:

- Press Auto on the control panel of the projector or the remote control unit to get better picture quality.
- Adjust the focus.
- Reposition the unit to improve its projection angle.
- Ensure the distance between the unit and screen is within the adjustment range of the lens.

① REMOTE CONTROL DOES NOT WORK

👉 Try these solutions:

- Replace the batteries with new ones.
- Make sure there is no obstacle between the remote control and the projector.
- Stand within 6 meters (19.5 feet) of the projector.
- Make sure nothing is blocking the front and rear receivers.

Status Messages

On-Screen Messages	Description
SEARCHING	Projector is searching for input.
ACQUIRING SIGNAL	Projector has identified the input signal and is running the auto image adjustment function.
OUT OF RANGE	Input signal frequency exceeds the projector's range.
Lamp Warning - Change Lamp If Brightness Is Low.	The lamp has been in operation for over 1980 hours. Install a new lamp for optimal performance. This message will display for 10 seconds after starting up the projector.
Out Of Lamp Usage Time - Change The Lamp! The Power Will Turn Off After 3000 Hours.	The lamp has been in operation for over 2980 hours, and the power will turn off after 3000 hours. This message will display for 30 seconds after starting up the projector.
Out Of Lamp Usage Time - Change The Lamp! Press <MENU> to enable <RESET>	The lamp has been in operation for over 3000 hours. The warning message will display for 40 seconds and then shut down automatically. If you have installed a new lamp, press <MENU> during the OSD on to enter for resetting the lamp hour to zero.

Specifications

Projector Specifications

Technical Specifications

 All specifications are subject to change without notice.

General

Product name	Digital Projector
Model name	PB6200 1024X768 XGA PB6100 800X600 SVGA

Optical

Display system	1-CHIP DMD
Lens F/Number	F = 2.4 to 2.6, f = 24.3 ~ 29.2 mm
Lamp	200W lamp

Electrical

Power supply	AC100 ~ 240V, 3.2A, 50/60 Hz (Automatic)
Power consumption	285W (Max)

Mechanical

Dimensions	262 mm (W) x 98.4 mm (H) x 215.5 mm (D)
Operating temperature range	0°C ~ 40°C
Weight	5.8 lbs (2.6 Kg)

Input terminal

Computer input	
RGB input	D-sub 15-pin (female)
Video signal input	
S-VIDEO	Mini DIN 4-pin port x1
VIDEO	RCA jack x1

Timing Chart

Resolution	H Sync (kHz)	V Sync (Hz)	Remark
640x350	31.5	70.1	
640x400	37.9	85.1	VESA
720x400	31.5	70.0	
720x400	37.9	85.1	VESA
640x480	31.5	60.0	VESA
640x480	37.9	72.8	VESA
640x480	35	66.7	Macintosh
640x480	43.3	85.0	VESA
800x600	35.2	56.3	VESA
800x600	37.9	60.3	VESA
800x600	46.9	75.0	VESA
800x600	48.1	72.2	VESA
800x600	53.7	85.1	VESA
832x624	49.7	74.5	Macintosh
1024x768	48.4	60.0	VESA
1024x768	56.5	70.1	VESA
1024x768	60.0	75.0	VESA
1024x768	68.7	85.0	VESA
1280x1024	64.0	60.0	VESA

8 Dimensions

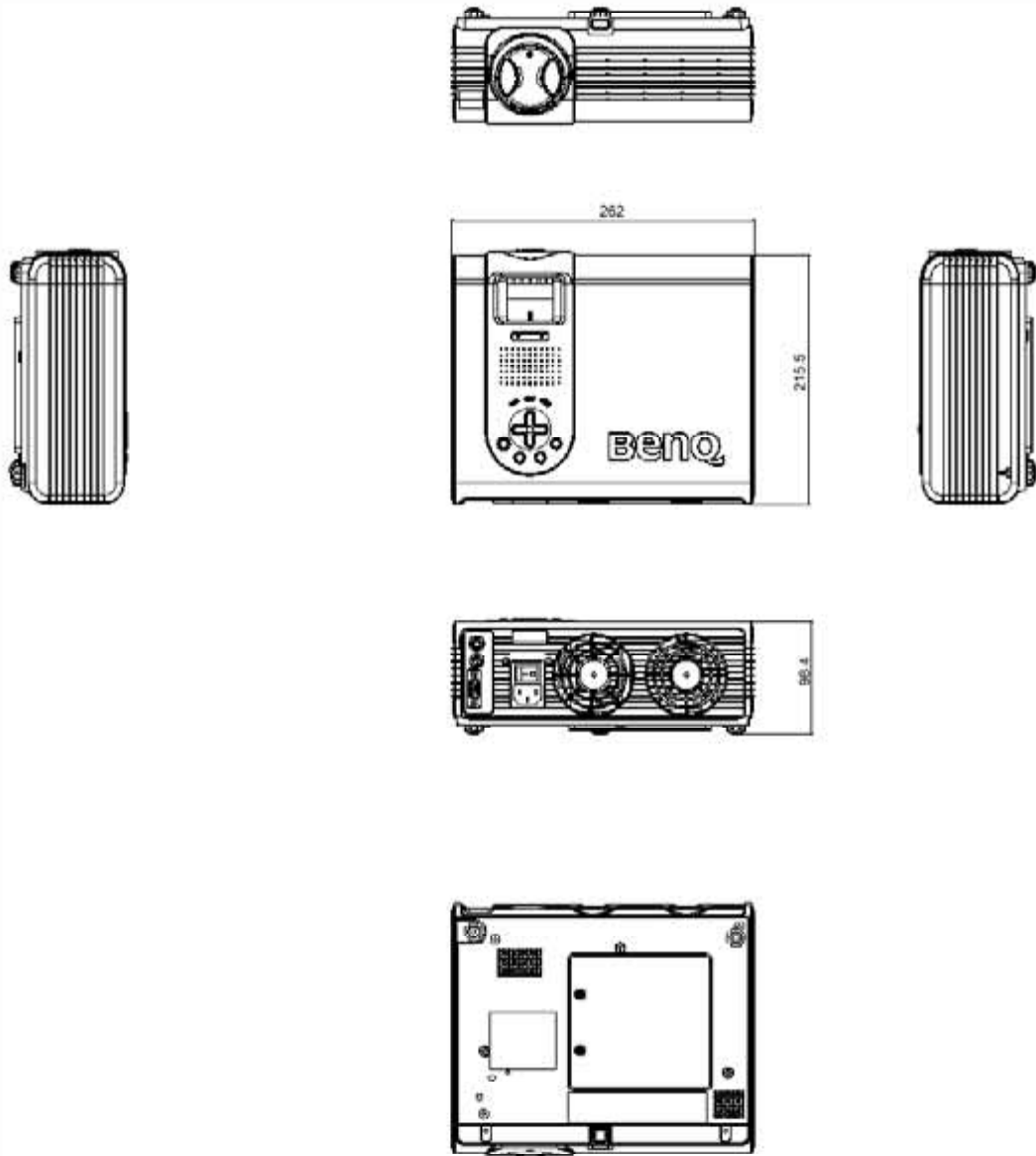

Unit: mm

Warranty

Limited Warranty

BENQ warrants this product against any defects in material and workmanship, under normal usage and storage.

Exclusion to Warranty: The lamps are considered a consumable item and are warranted for 90 days or 1000 hours, whichever occurs first. Proof of purchase date will be required with any warranty claim. In the event this product is found to be defective within the warranty period, BENQ's only obligation and your exclusive remedy shall be replacement of any defective parts (labor included). To obtain warranty service, immediately notify the dealer from which you purchased the product of any defects.

Important: The above warranty shall be void if the customer fails to operate the product in accordance with BENQ's written instructions. This warranty gives you specific legal rights, and you may have other rights which vary from country to country.

For other information, please refer to BenQ Warranty Information Book.

10 Safety Regulations

FCC Statement

CLASS A: This equipment generates, uses and can radiate radio frequency energy, and if not installed and used in accordance with the instruction manual, may cause interference to radio communications. It has been tested and found to comply with the limits for a Class “A” computing device pursuant to Subpart B of Part 15 of the FCC Rules, which are designed to provide reasonable protection against such interference when operated in a commercial environment. Operation of this equipment in a residential area is likely to cause interference, in which case the user at his/her own expense will be required to take whatever measures may be required to correct the interference.

CLASS B: This equipment generates, uses and can radiate radio frequency energy and, if not installed and used in accordance with the instructions, may cause harmful interference to radio communications. However, there is no guarantee that interference will not occur in a particular installation. If this equipment does cause harmful interference to radio or television reception, which can be determined by turning the equipment off and on, the user is encouraged to try to correct the interference by one or more of the following measures:

- Reorient or relocate the receiving antenna.
- Increase the distance between the equipment and receiver.
- Connect the equipment into an outlet on a circuit different from that to which the receiver is connected.
- Consult the dealer or an experienced radio/TV technician for help.

EEC Statement

This machine was tested against the 89/336/EEC (European Economic Community) for EMC (Electro Magnetic Compatibility) and fulfills these requirements.

MIC Statement

A class equipment (Business purpose info/telecommunications equipment)

As this equipment has undergone EMC registration for business purpose, the seller and/or the buyer is asked to beware of this point and in case a wrongful sale or purchase has been made, it is asked that a change to household use be made.

B class equipment (Household purpose info/telecommunications equipment)

As this equipment has undergone EMC registration for household purpose, this product can be used in any area including residential area.