

BenQ

PB2250 Digital Projector

Mobile Series

User's Manual

Welcome

Copyright

Copyright 2005 by BenQ Corporation. All rights reserved. No part of this publication may be reproduced, transmitted, transcribed, stored in a retrieval system or translated into any language or computer language, in any form or by any means, electronic, mechanical, magnetic, optical, chemical, manual or otherwise, without the prior written permission of BenQ Corporation.

Disclaimer

BenQ Corporation makes no representations or warranties, either expressed or implied, with respect to the contents hereof and specifically disclaims any warranties, merchantability or fitness for any particular purpose. Further, BenQ Corporation reserves the right to revise this publication and to make changes from time to time in the contents hereof without obligation to notify any person of such revision or changes.

*DLP, Digital Micromirror Device and DMD are trademarks of Texas Instruments. Others are copyrights of their respective companies or organizations.

Table of Contents

| | |
|--|----|
| Important safety instructions | 1 |
| Introduction | 5 |
| Projector features | 5 |
| Shipping contents | 6 |
| Optional accessories | 6 |
| Projector exterior view | 7 |
| Front / Upper side | 7 |
| Rear side | 7 |
| Bottom side | 7 |
| Controls and functions | 8 |
| External control panel | 8 |
| Remote control description | 9 |
| Remote control effective range | 10 |
| Installing or replacing the remote control battery | 10 |
| Positioning your projector | 11 |
| Choosing a location | 11 |
| Obtaining a preferred projected image size | 12 |
| Connection | 14 |
| Connecting to a laptop or desktop computer | 14 |
| Connecting equipment to the Component Video input | 15 |
| Connecting Video and S-Video devices | 15 |
| Operation | 17 |
| Start up | 17 |
| Utilizing the password function | 17 |
| Adjusting the image | 19 |
| Adjusting the height | 19 |
| Auto-adjusting the image | 19 |
| Fine-tuning the image size and clarity | 19 |
| Correcting keystone | 20 |
| Switching input signals | 21 |
| Hiding the image | 21 |
| Shutdown | 21 |
| Menu operation | 22 |
| Menu system | 22 |

| | |
|---|-----------|
| Using the menus | 23 |
| 1. Picture menu | 24 |
| 2. Pro-Picture menu | 25 |
| 3. Setting menu | 26 |
| 4. Advance menu | 27 |
| 5. Information Menu | 28 |
| Maintenance | 29 |
| Care of the projector | 29 |
| Cleaning the lens | 29 |
| Cleaning the projector case | 29 |
| Storing the projector | 29 |
| Transporting the projector | 29 |
| Lamp information | 30 |
| Warning message | 30 |
| Replacing the lamp | 30 |
| Temperature information | 32 |
| Indicators | 32 |
| Service information | 34 |
| Accessories (included in the standard package) | 34 |
| Alternative accessories (vary by regions) | 34 |
| Optional accessories (not included in the standard package) | 34 |
| Ordering parts or getting information | 34 |
| Troubleshooting | 35 |
| Specifications | 36 |
| Projector specifications | 36 |
| Dimensions | 37 |
| Timing chart | 38 |
| Supported timing for PC input | 38 |
| Supported timing for Component-YPbPr Input | 38 |
| Supported timing for Video and S-Video inputs | 38 |
| Warranty | 40 |
| Limited warranty | 40 |
| Regulation statements | 41 |
| FCC statement | 41 |
| EEC statement | 41 |
| MIC statement | 41 |

1 Important safety instructions

Your BenQ projector is designed and tested to meet the latest standards for safety of information technology equipment. However, to ensure safe use of this product, it is important that you follow the instructions mentioned in this manual and marked on the product.

Caution

- **To prevent shock, do not open the cabinet.** There are no user serviceable parts inside.

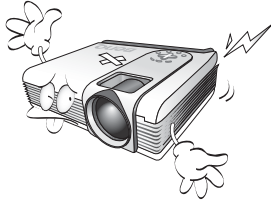

- **Please read this user's manual before you operate your projector.** Save this user's manual for future reference.

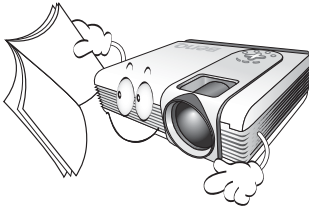

- **Do not look straight at the projector lens during operation.** The intense light beam may damage your eyes.

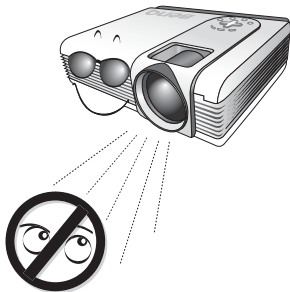

- **Refer servicing to qualified service personnel.**



- **Always open the lens shutter or remove the lens cap when the projector lamp is on.**



- In some countries, the line voltage is NOT stable. This projector is designed to operate safely within a mains voltage between 100 to 240 volts AC, but could fail if power cuts or surges of ± 10 volts occur. **In areas where the mains voltage may fluctuate or cut out, it is recommended that you connect your projector through a power stabilizer, surge protector or uninterruptible power supply (UPS).**

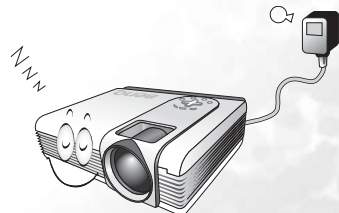

Safety instructions

1. The lamp becomes extremely hot during operation. Allow the projector to cool for approximately 45 minutes prior to removing the lamp assembly for replacement.

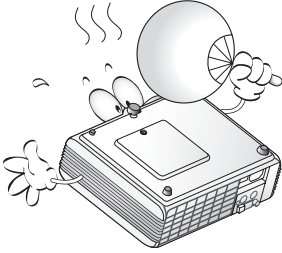

2. Do not operate lamps beyond the rated lamp life. Excessive operation of lamps beyond the rated life could cause them to break on rare occasions.

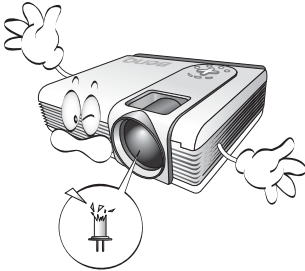

3. Never replace the lamp assembly or any electronic components unless the projector is unplugged.

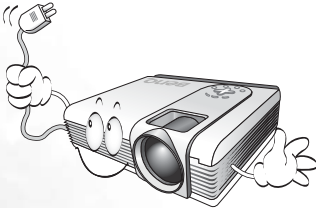

4. Do not place this product on an unstable cart, stand, or table. The product may fall, sustaining serious damage.

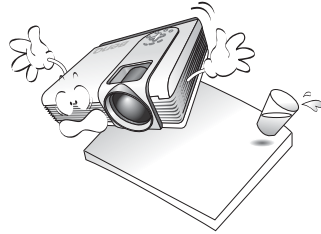

5. To reduce the risk of electric shock, do not disassemble this appliance. Take it to a qualified technician when service or repair is required. Incorrect reassembly can cause malfunction of the projector or electric shock when the appliance is subsequently used.

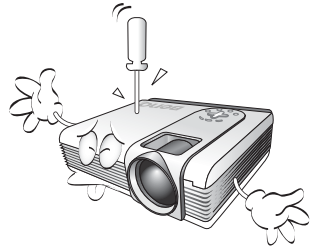

6. This product is capable of displaying inverted images for ceiling mount installation. Please use BenQ's Ceiling Mounting Kit for mounting the unit and ensure it is securely installed.

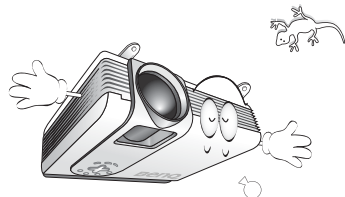

Safety instructions (continued)

7. Do not place this projector in any of the following environments.

- Space that is poorly ventilated or confined. Allow at least 50 cm clearance from walls and free flow of air around the projector.
- Locations where temperatures may become excessively high, such as the inside of a car with all windows rolled up.
- Locations where excessive humidity, dust, or cigarette smoke may contaminate optical components, shortening the projector's life span and darkening the image.



- Locations near fire alarms
- Locations with an ambient temperature above 40°C / 104°F
- Locations where the altitudes are higher than 10000 feet.

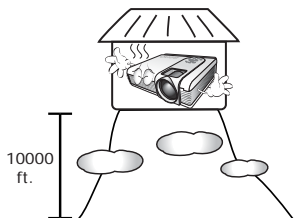

8. Do not block the ventilation holes.

- Do not place this unit on a blanket, bedding or any other soft surface.
- Do not cover this unit with a cloth or any other item.
- Do not place inflammables near the projector.



If the ventilation holes are seriously obstructed, overheating inside the unit may result in a fire.

9. Always place the unit on a level, horizontal surface during operation.

- Do not use if tilted at an angle of more than 10 degrees left to right, nor at angle of more than 15 degrees front to back. Using the unit when it is not fully horizontal may cause a malfunction of, or damage to, the lamp.

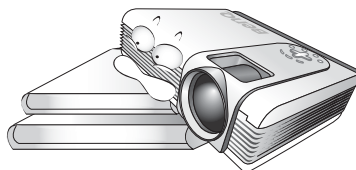

10. Do not stand the unit on end vertically.

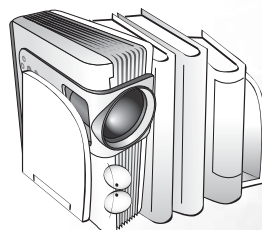

Doing so may cause the unit to fall over, causing injury or resulting in damage to the unit.

Safety instructions (continued)

11. Do not step on the projector or place any objects upon it.



Besides probable physical damage to the projector, doing so may result in accidents and possible injury.

12. Do not block the projection lens with any objects when the projector is under operation as this could cause the objects to become heated or deformed or even cause a fire. To temporarily turn off the lamp, press **Blank** on the projector or remote control.

13. Do not place liquids near or on the projector. Liquids spilled into the projector may cause it to fail. If the projector does become wet, disconnect it from the power supply's wall socket and call BenQ to have the projector serviced.



2 Introduction

Projector features

The projector integrates high-performance optical engine projection and a user-friendly design to deliver high reliability and ease of use.

The projector offers the following features:

- Selectable password protected function
- Compact and portable unit
- High quality manual zoom lens
- One-key auto-adjustment to display the best picture quality
- Digital keystone correction to correct distorted images
- Adjustable color balance control for data/video display
- Ultra-high brightness projection lamp
- Ability to display 16.7 million colors
- On-screen menus in 10 languages: English, French, German, Italian, Spanish, Russian, Traditional Chinese, Simplified Chinese, Japanese, and Korean.
- Switchable normal and Economic modes to reduce the power consumption
- Powerful AV function to provide high quality AV picture
- HDTV compatibility (YPbPr)

 **Note: The brightness of the projected image will vary depending on the ambient lighting conditions and contrast/brightness settings.**

 **The lamp brightness will decline over time and may vary within the lamp manufacturers specifications. This is normal and expected behavior.**

Shipping contents

The projector is shipped with the cables required for connection to a PC and to video equipment. Carefully unpack and verify that you have all of the items shown below. If any of these items are missing, please contact your place of purchase.

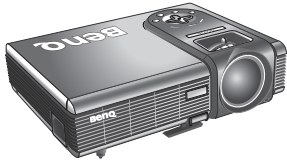

Projector



Soft Carry Case



User's Manual



Warranty Booklet

 **Pull the tab before using the remote control.**



User's Manual CD



Quick Start Guide

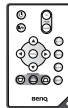

Remote Control and Battery

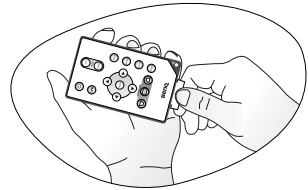

USB Cable



S-Video Cable



Video Cable



VGA Cable



Audio Cables



3-2 power adaptor (US only)



Power Cord*

***The supplied power cord will be suitable for your region, and may differ from that illustrated.**

Optional accessories

- | | |
|--|--------------------------|
| 1. Macintosh adapter | 4. Wireless Pro |
| 2. 200W lamp module (replacement or spare) | 5. Presentation Plus |
| 3. Ceiling mount kit | 6. Component Video cable |

Projector exterior view

Front / Upper side

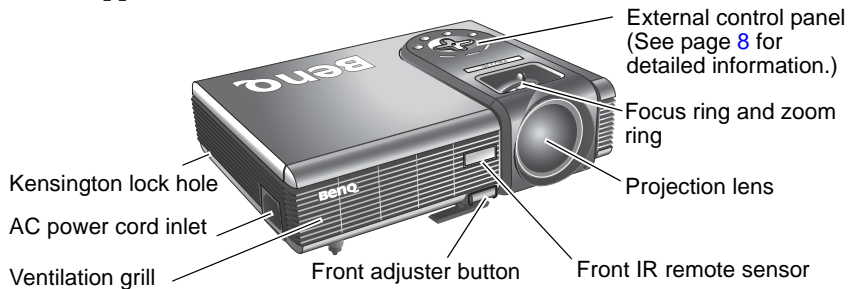

Rear side

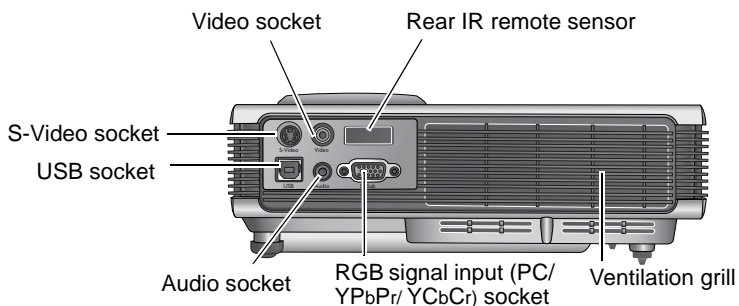

Bottom side

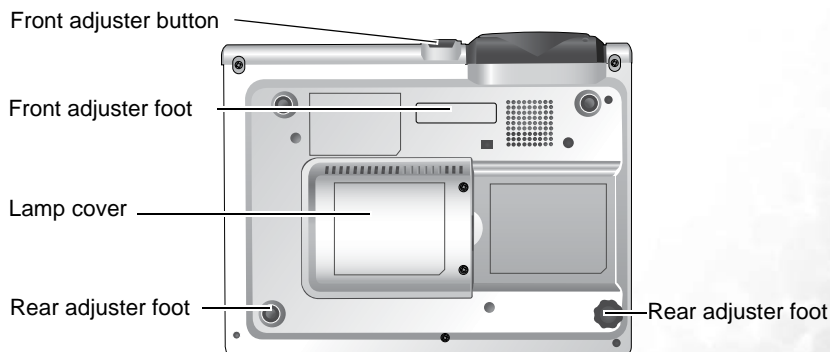

Controls and functions

External control panel

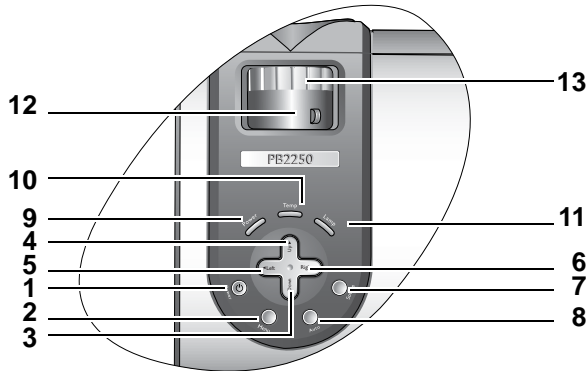

- 1. Power** (Refer to pages [17](#) and [21](#) for more information.)
Turns the projector on or off.
- 2. Menu**
Opens, saves and exits the on-screen menu.
- 3. Down** ▾
- 4. ^ Up**
- 5. ◀ Left**
- 6. Right ▶**
The #2 to #6 buttons are used to select the desired menu items and to make adjustments when the on-screen menu is activated. Refer to page [23](#) for more information.
When the on-screen menu is not activated, the ◀ **Left** and **Right** ▶ buttons function as **Keystone** -/+ hot keys. Refer to page [19](#) for more information.
- 7. Source** (Refer to page [21](#) for information.)
Sequentially selects the input signal RGB/YPbPr, Video, or S-Video.
- 8. Auto** (Refer to page [19](#) for more information.)
Automatically determines the best picture settings for the displayed image.
- 9. Power indicator light** (Refer to page [32](#) for more information.)
Lights up or flashes when the projector is under operation.
- 10. Temperature warning light** (Refer to page [32](#) for more information.)
Flashes red if the projector's temperature becomes too high.
- 11. Lamp indicator light** (Refer to page [32](#) for more information.)
Indicates the status of the lamp.
Lights up or flashes when the lamp has developed a problem.
- 12. Zoom ring** (Refer to page [19](#) for more information.)
Adjusts the size of the image.
- 13. Focus ring** (Refer to page [19](#) for more information.)
Adjusts the focus of the projected image.

Remote control description

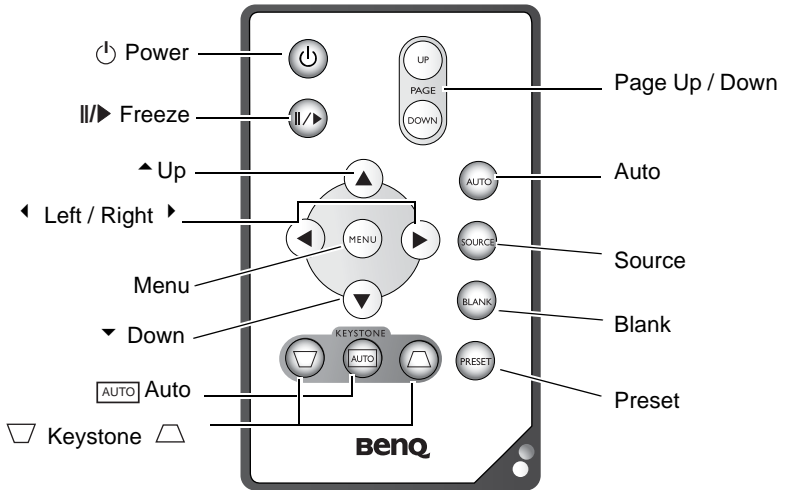

| Functions | Descriptions |
|------------------------------|---|
| Power | Turns the projector on or off. Refer to pages 17 and 21 for more information. |
| Freeze | The image is frozen when Freeze is pressed. A "Pause" icon will appear in the lower right corner of the screen. To release the function, press Freeze again, or Source (this will change the input source and release the pause function). |
| Up, Menu, Left / Right, Down | Used to select the desired menu items and to make adjustments. Refer to page 23 for more information. |
| Auto keystone | Automatically corrects trapezoidal distortion resulting from the angle of projection. Refer to page 19 for more information. |
| Keystone | Manually corrects distorted images resulting from the angles of projection. Refer to page 19 for more information. |
| Page Up and Down | Connect the projector to your PC or notebook with a USB cable prior to using this function. You can operate your display application (like a Power Point presentation) moving forwards and backwards. |
| Auto | Automatically determines the best picture settings for displayed image. Refer to page 19 for more information. |
| Source | Sequentially select the input signal RGB, Component Video, S-Video or Video. Refer to page 21 for information. |
| Blank | Hides the image. Refer to page 21 for more information. |

| | |
|--------|--|
| Preset | According to the selected input signal, there are several picture setup options available: Vivid mode, Presentation mode, Gaming mode, Video mode, Cinema mode and Economic mode. Refer to page 24 for more information. |
|--------|--|

Remote control effective range

Infra Red (IR) remote control sensors are located on the front and the back of the projector. The remote control must be held at an angle within 30 degrees of the projector's IR remote control sensors to function correctly. The distance between the remote control and the sensors should not exceed 6 meters (~ 20 feet).

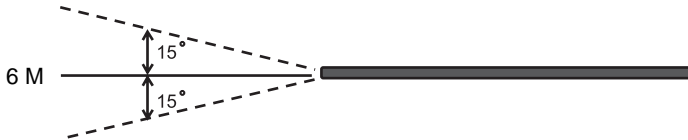

Notes on Remote Control Operation:

Make sure that there are no obstacles between the remote control and the IR sensors on the projector that might obstruct the infra-red beam.

If the remote control stops working, or if its effective range decreases, replace the battery with new ones.

Installing or replacing the remote control battery

1. Pull out the battery holder.
2. Insert the new battery in the holder.
3. Push the holder into the remote control.

 **Avoid excessive heat and humidity. There may be danger of damage to the remote and injury to those nearby if the battery is incorrectly replaced.**

Replace only with the same or equivalent type recommended by the manufacturer.

Dispose of the used battery according to the manufacturer's instructions.

Never throw a battery into a fire.

If the battery is dead or if you will not be using the remote control for a long time, remove the battery to prevent damage to the remote control from possible battery leakage.

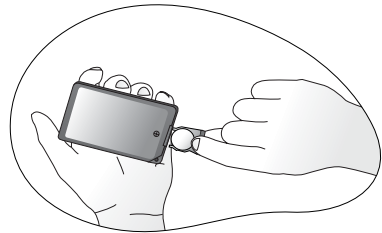

3 Positioning your projector

Choosing a location

Your projector is designed to be installed in one of four possible installation locations:

1. Floor in front of screen;
2. Ceiling in front of screen;
3. Floor at rear of screen; or
4. Ceiling at rear of screen.

Your room layout or personal preference will dictate which installation location you select. Take into consideration the size and position of your screen, the location of a suitable power outlet, as well as the location and distance between the projector and the rest of your equipment.

I. Floor front: Select this location with the projector placed near the floor in front of the screen. This is the most common way to position the projector for quick setup and portability.

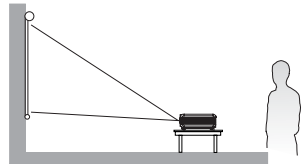

II. Ceiling front: Select this location with the projector suspended from the ceiling in front of the screen.

Purchase the BenQ Projector Ceiling Mounting Kit from your dealer to mount your projector on the ceiling.

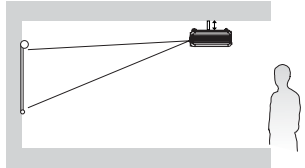

Set  in the **Advance > Mirror** menu after you turn the projector on.

III. Floor rear: Select this location with the projector placed near the floor behind the screen.

Note that a special rear projection screen is required.

Set  in the **Advance > Mirror** menu after you turn the projector on.

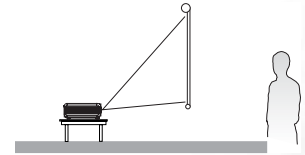

IV. Ceiling rear: Select this location with the projector suspended from the ceiling behind the screen.

Note that a special rear projection screen and the BenQ Projector Ceiling Mounting Kit are required for this installation location.

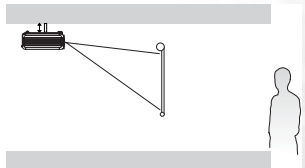

Set  in the **Advance > Mirror** menu after you turn the projector on.

Obtaining a preferred projected image size

The distance from the projector lens to the screen, the zoom setting, and the video format each factors in the projected image size. BenQ has provided separate tables of dimensions for both 16:9 and 4:3 screen ratios to assist you in determining the ideal location for your projector.

1. Determine the aspect ratio of your screen (4:3 or 16:9).
2. Determine the projection distance allowed in your room. Install the projector at a proper distance from the screen.
3. Refer to the table of 4:3 or 16:9 Screen Size depending on your screen ratio. Locate the suitable value in the column of "Distance from Screen". In the same row, you will find the maximum and minimum projected image sizes.
4. Determine the preferred height of your projector.

For example, if you are using a 4:3 screen with 2.5 meters projection distance, the maximum image size is close to 1.91 meters diagonal.

If you place the projector above or below the screen, you have to tilt it down or up to center the image on the screen after turning the projector on. In these situations, some image distortion will occur. Use the Keystone function to correct the distortion. See page 19 for keystone correction.

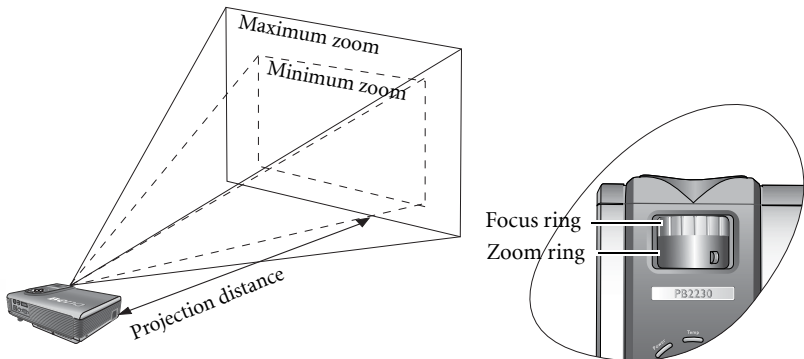

Screen size chart (4:3 aspect ratio)

| Distance from screen | | Diagonal measurement | | | |
|----------------------|------|----------------------|-------|--------------|-------|
| | | Minimum zoom | | Maximum zoom | |
| feet | inch | feet | inch | feet | inch |
| 4 | 48 | 2.49 | 29.9 | 3.05 | 36.6 |
| 6 | 72 | 3.73 | 44.8 | 4.57 | 54.9 |
| 8 | 96 | 4.98 | 59.7 | 6.10 | 73.2 |
| 10 | 120 | 6.22 | 74.7 | 7.62 | 91.4 |
| 12 | 144 | 7.47 | 89.6 | 9.14 | 109.7 |
| 14 | 168 | 8.71 | 104.5 | 10.67 | 128.0 |
| 16 | 192 | 9.96 | 119.5 | 12.19 | 146.3 |
| 18 | 216 | 11.20 | 134.4 | 13.72 | 164.6 |
| 20 | 240 | 12.45 | 149.4 | 15.24 | 182.9 |
| 22 | 264 | 13.69 | 164.3 | 16.76 | 201.2 |
| 24 | 288 | 14.94 | 179.2 | 18.29 | 219.5 |
| 26 | 312 | 16.18 | 194.2 | 19.81 | 237.7 |
| 28 | 336 | 17.42 | 209.1 | 21.34 | 256.0 |
| 30 | 360 | 18.67 | 224.0 | 22.86 | 274.3 |
| 32 | 384 | 19.91 | 239.0 | 24.38 | 292.6 |
| 34 | 408 | 21.16 | 253.9 | 25.91 | 310.9 |

| Distance from screen | | Diagonal measurement | | | |
|----------------------|-----|----------------------|-------|--------------|-------|
| | | Minimum zoom | | Maximum zoom | |
| meter | cm | meter | cm | meter | cm |
| 1 | 100 | 0.62 | 62.2 | 0.76 | 76.2 |
| 1.5 | 150 | 0.93 | 93.3 | 1.14 | 114.3 |
| 2 | 200 | 1.24 | 124.5 | 1.52 | 152.4 |
| 2.5 | 250 | 1.56 | 155.6 | 1.91 | 190.5 |
| 3 | 300 | 1.87 | 186.7 | 2.29 | 228.6 |
| 3.5 | 350 | 2.18 | 217.8 | 2.67 | 266.7 |
| 4 | 400 | 2.49 | 248.9 | 3.05 | 304.8 |
| 4.5 | 450 | 2.80 | 280.0 | 3.43 | 342.9 |
| 5 | 500 | 3.11 | 311.2 | 3.81 | 381.0 |
| 5.5 | 550 | 3.42 | 342.3 | 4.19 | 419.1 |
| 6 | 600 | 3.73 | 373.4 | 4.57 | 457.2 |
| 6.5 | 650 | 4.04 | 404.5 | 4.95 | 495.3 |
| 7 | 700 | 4.36 | 435.6 | 5.33 | 533.4 |
| 7.5 | 750 | 4.67 | 466.7 | 5.72 | 571.5 |
| 8 | 800 | 4.98 | 497.8 | 6.10 | 609.6 |
| 8.5 | 850 | 5.40 | 539.8 | 6.48 | 647.7 |

Screen size chart (16:9 aspect ratio)

| Distance from screen | | Diagonal measurement | | | |
|----------------------|------|----------------------|-------|--------------|-------|
| | | Minimum zoom | | Maximum zoom | |
| feet | inch | feet | inch | feet | inch |
| 4 | 48 | 2.29 | 27.5 | 2.80 | 33.6 |
| 6 | 72 | 3.44 | 41.3 | 4.20 | 50.4 |
| 8 | 96 | 4.59 | 55.1 | 5.60 | 67.2 |
| 10 | 120 | 5.74 | 68.8 | 7.00 | 84.0 |
| 12 | 144 | 6.88 | 82.6 | 8.40 | 100.8 |
| 14 | 168 | 8.03 | 96.4 | 9.80 | 117.6 |
| 16 | 192 | 9.18 | 110.1 | 11.20 | 134.4 |
| 18 | 216 | 10.32 | 123.9 | 12.60 | 151.2 |
| 20 | 240 | 11.47 | 137.7 | 14.00 | 167.9 |
| 22 | 264 | 12.62 | 151.4 | 15.39 | 184.7 |
| 24 | 288 | 13.77 | 165.2 | 16.79 | 201.5 |
| 26 | 312 | 14.91 | 179.0 | 18.19 | 218.3 |
| 28 | 336 | 16.06 | 192.7 | 19.59 | 235.1 |
| 30 | 360 | 17.21 | 206.5 | 20.99 | 251.9 |
| 32 | 384 | 18.35 | 220.3 | 22.39 | 268.7 |

| Distance from screen | | Diagonal measurement | | | |
|----------------------|-----|----------------------|-------|--------------|-------|
| | | Minimum zoom | | Maximum zoom | |
| meter | cm | meter | cm | meter | cm |
| 1 | 100 | 0.57 | 57.4 | 0.70 | 70.0 |
| 1.5 | 150 | 0.86 | 86.0 | 1.05 | 105.0 |
| 2 | 200 | 1.15 | 114.7 | 1.40 | 140.0 |
| 2.5 | 250 | 1.43 | 143.4 | 1.75 | 179.4 |
| 3 | 300 | 1.72 | 172.1 | 2.10 | 209.9 |
| 3.5 | 350 | 2.01 | 200.8 | 2.45 | 244.9 |
| 4 | 400 | 2.29 | 229.4 | 2.80 | 279.9 |
| 4.5 | 450 | 2.58 | 258.1 | 3.15 | 314.9 |
| 5 | 500 | 2.87 | 286.8 | 3.50 | 349.9 |
| 5.5 | 550 | 3.15 | 315.5 | 3.85 | 384.9 |
| 6 | 600 | 3.44 | 344.1 | 4.20 | 419.9 |
| 6.5 | 650 | 3.73 | 372.8 | 4.55 | 454.9 |
| 7 | 700 | 4.02 | 401.5 | 4.90 | 489.9 |
| 7.5 | 750 | 4.30 | 430.2 | 5.25 | 524.8 |
| 8 | 800 | 4.59 | 458.9 | 5.60 | 559.8 |

 The recommended focus range is from 1.5 ~ 8 meters (6 ~ 32 feet).

There is 3% ~ 5% tolerance among these numbers due to optical component variations.

* 1 m = 3.28 feet, 1 foot = 0.305 m

4 Connection

When connecting a signal source to the projector, be sure to:

1. Turn all of the equipment off before making any connections.
2. Use the correct signal cables for each source.
3. Ensure that the cables are firmly inserted.

Connecting to a laptop or desktop computer

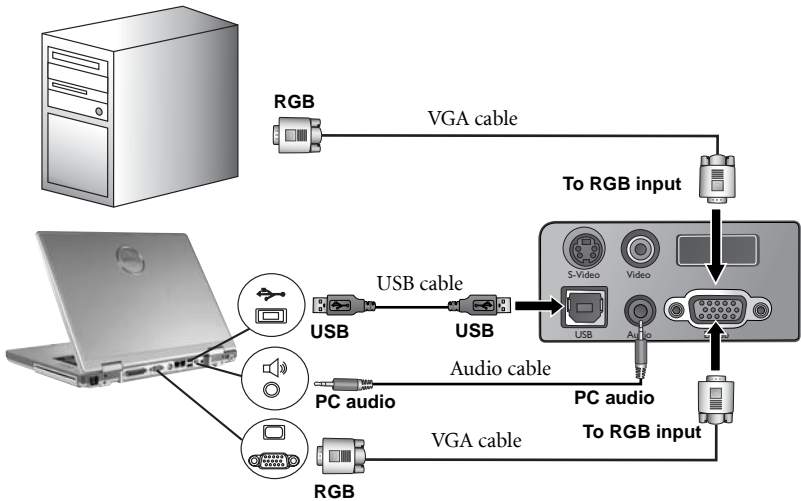

 A Mac adapter (an optional accessory) is needed if you are connecting to Macintosh computers.

Many laptops do not turn on their external video ports when connected to a projector. Usually a key combo like FN + F3 or CRT/LCD key turns the external display on/off. Locate a function key labeled CRT/LCD or a function key with a monitor symbol on the laptop. Press FN and the labeled function key simultaneously. Refer to your laptop's documentation to learn your laptop's key combination.

Connecting equipment to the Component Video input

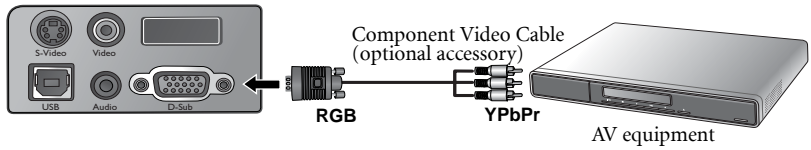

The projector is capable of displaying various High Definition TV display modes. Some of these sources are:

- Digital-VHS (D-VHS) player
- DVD player
- Satellite Dish HDTV receiver
- Digital TV tuners

Most of these sources will provide an analog component video output, either a standard VGA (D-sub) output, or a YPbPr (default) format.

The projector is capable of accepting digital TV data through a Component Video connector. Use a Component Video cable (optional accessory) to display these images.

The following standards are supported in the digital TV function:

- 480i
- 480p
- 576i
- 576p
- 720p (50/ 60 Hz)
- 1080i (50/ 60 Hz)

Connecting Video and S-Video devices

S-Video devices

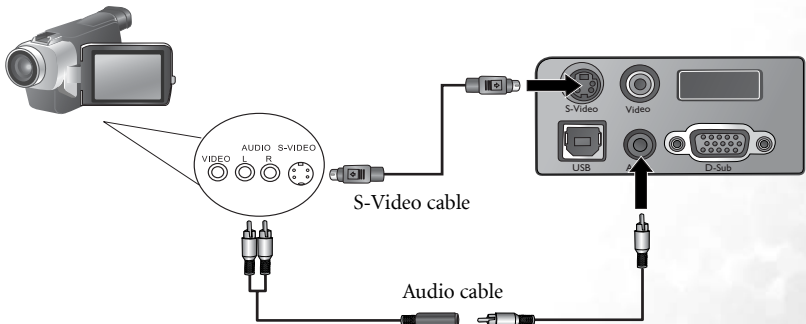

Video devices

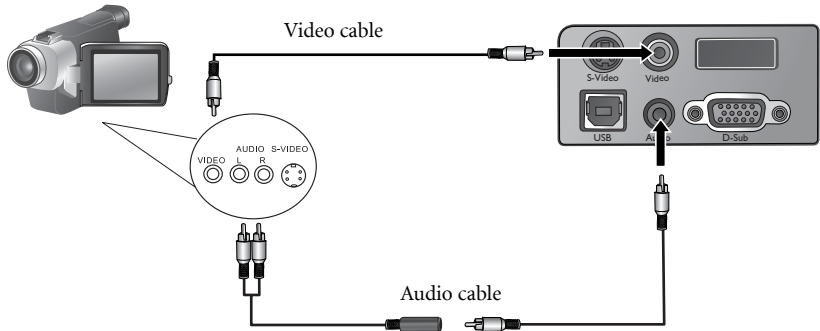

☞ If the selected video image is not displayed after the projector is turned on and the correct video source has been selected, check that the video source is turned on and operating correctly. Also check that the signal cables have been connected correctly.

5 Operation

Start up

1. Switch all of the connected equipment on.
2. Plug the power cord into the projector and into a wall socket. Turn on the wall socket switch (where fitted). Turn on the power point (if switched). Check that the **Power indicator** on the projector lights orange after power has been applied.
3. Remove the lens cap. If it is left on, it could become deformed due to heat.
4. Press and hold (for 2 seconds) the **Power** button on the remote control or projector to start the unit. The **Power indicator light** flashes green and stays green when the unit is on.
5. The start up procedure takes about 30 seconds after pressing **Power**. In the later stage of start up, a default BenQ logo is projected.
6. If you are prompted for a password, press the arrow buttons to select the four password digits, then press **Auto**. For information about the password function, refer to page 17.
7. The projector will start to search for input signals. The projector screen displays the current input source being scanned at the bottom right corner of the screen. If no input source signal is detected, the search will continue until an input source signal is detected.
8. You can also press **Source** on the projector or remote control to select an input signal to display. For more information, please refer to page 21.

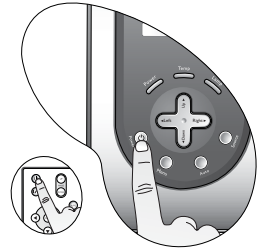
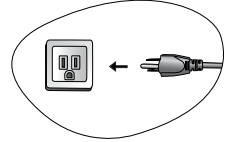

 **If the frequency/ resolution of the input signal exceeds the projector's operating range, you will see the message "Out of Range" displayed on a blank screen.**





Utilizing the password function

For security purposes and to help prevent unauthorized use, the projector includes an option for setting up password security. The password can be set through the on-screen menu. For details of the on-screen menu operation, please refer to page 23 for information.

 **WARNING: You will be inconvenienced if you activate the password functionality and subsequently forget the password. Write the password you used in this manual, and keep the manual in a safe place for later recall.**

To set a password:

 **CAUTION: Once a password has been set, the projector cannot be used unless the correct password is entered every time the projector is started.**

1. Open the on-screen menu and go to  **Setting > Password**. Select  by pressing  or .

2. When the function is activated for the first time, a prompt will display on the screen. Use the **▲** or **▼** buttons to select a number for each digit of the password. Use the **◀** or **▶** buttons to move between the digits of the password..
3. When all digits are entered and the password is ready, press **Auto** to confirm. A confirmation message displays.

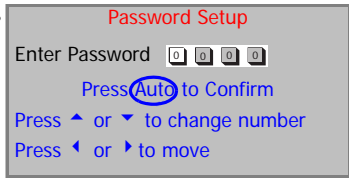

IMPORTANT: Write your selected password down here in this manual so that it is available to you should you ever forget it.

Password: _ _ _ _

Keep this manual in a safe place.

- i. Press **Auto** to continue. The set-up is finished when the message “Password setup completed” displays.
- ii. Press **▲** to go back to the previous screen and re-enter four digits.
- iii. Press **▼** to cancel the password set-up and return to the on-screen menu.

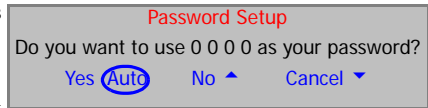

If you forget the password:

You will be asked to enter the four digit password every time you turn on the projector. If you enter the wrong password, the password error message displays. You can retry by turning off the projector (by pressing **Power**) and start again, or if you did not record the password in this manual, and you absolutely do not remember it, you can use the password recall procedure.

To enter the password recall procedure:

Press and hold **▶** for 5 seconds. The projector will display a coded number on the screen. Seek help from the local BenQ service center to decode the number. You may be required to provide proof of purchase documentation to verify that you are an authorized user of the projector.

To change the password:

1. Open the on-screen menu and go to  **Setting > Change Password**.
2. Press **◀** or **▶**. A “Change Password” message displays.
3. Enter the old password.
 - i. If the password is correct, you can go on to enter new password.

IMPORTANT: Write your selected password down here in this manual so that it is available to you should you ever forget it.

Password: _ _ _ _

Keep this manual in a safe place.

- ii. If the password is incorrect, a “Password Error” message displays. Press **▲** to try again or press **▼** to cancel.
4. Check the new password.
 - i. Pressing **Auto** completes the procedure.
 - ii. Press **▲** to try again.
 - iii. Press **▼** to cancel the set-up and return to the on-screen menu.

Adjusting the image

Adjusting the height

The projector is equipped with 1 quick-release adjuster foot and 2 rear adjuster feet. These adjusters can be used to change the image height and projection angle. To adjust the projector,

1. Lift the projector up and press the adjuster button to release the adjuster. The adjuster will drop into position.

 **Do not look into the lens while the lamp is on. The strong light from the lamp may cause damage to your eyes.**

2. Screw the rear adjuster feet to fine tune the horizontal angle.

To retract the foot, press the adjuster button again.

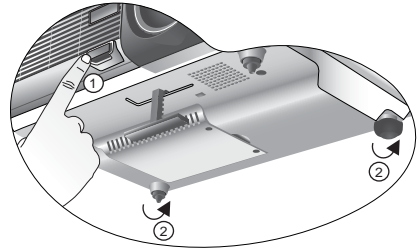

 **If the screen and the projector are not perpendicular to each other, the projected image becomes vertically trapezoidal. To correct this situation, adjust the value of Keystone in the Picture menu, on the projector control panel or on the remote control.**

Auto-adjusting the image

In some cases, you may need to optimize the picture quality. To do this, press **Auto** on the control panel of the projector or on the remote control. Within 3 seconds, the built-in Intelligent Auto Adjustment function will re-adjust the values of Frequency, Clock and Keystone to provide the best picture quality.

 **The screen will be blank while the auto-adjustment is functioning.**

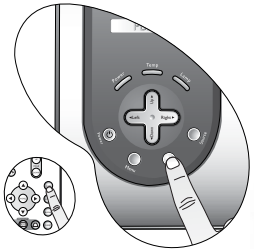

Fine-tuning the image size and clarity

1. Adjust the projected image to the size that you need using the zoom ring.
2. Then sharpen the image by rotating the focus ring.

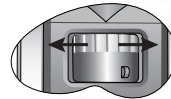
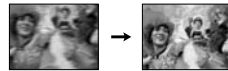
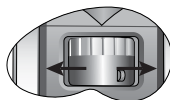

Refer to the screen size tables on page 13.

Correcting keystone



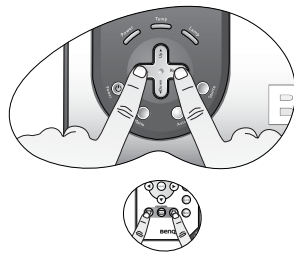

Keystoning refers to the situation where the projected image is noticeably wider at either the top or bottom. It occurs when the projector is not perpendicular to the screen.

To correct this, you can perform the following steps.









1. Adjust the height of the projector.
2. Press **Keystone**  on the remote control or **Auto** on the projector.



If the image is still distorted, you will need to manually correct it following ONE of these steps.

- Press **Left/ Right** (hot key) on the control panel of the projector to display the status bar labelled Keystone. Press **Left** to correct keystoning at the top of the image. Press **Right** to correct keystoning at the bottom of the image.
- Press  /  on the remote control to display the status bar labelled Keystone, then press  to correct keystoning at the top of the image or press  to correct keystoning at the bottom of the image.
- Press **Menu** key on the projector or the remote control. Go to  **Picture** --> **Keystone** and adjust the values by pressing **Left/ Right** on the projector or **Left/ Right** on the remote control.

For example,

| | | |
|---|---|--|
| | <ol style="list-style-type: none"> 1. Press Left on the projector or 2. Press  on the remote control or 3. Press Left on the projector or  on the remote control when you are in Picture --> Keystone menu. | |
| <p>Keystone  0</p> | | <p>Keystone  -6</p> |
| | <ol style="list-style-type: none"> 1. Press Right on the projector or 2. Press  on the remote control or 3. Press Right on the projector or  on the remote control when you are in Picture --> Keystone menu. | |
| <p>Keystone  0</p> | | <p>Keystone  +6</p> |

Switching input signals

The projector can be connected to multiple devices at the same time. To sequentially select input sources, press the **Source** button on the projector control panel or the remote control. The selected source will be displayed at the bottom right of the screen for 3 seconds.

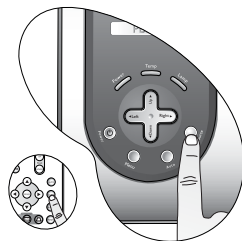

Hiding the image

In order to draw the audience's full attention to the presenter during a presentation, you can use the **Blank** button to hide the screen image. Press the **Blank** button again to restore the image. A word "**BLANK**" will display at the bottom right corner of the screen when the image is hidden.

Set the duration of blank time in  **Advance > Blank Time** menu.

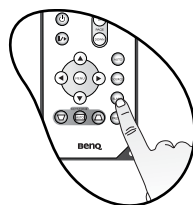



 **Do not block the projection lens from projecting as this could cause the blocking object to become heated and deformed or even cause a fire.**



Shutdown

1. Press **Power** and a confirmation prompt displays. Press **Power** a second time to turn the projector off.
2. The **Power indicator light** flashes orange and the lamp shuts down. The fans will continue to run for approximately 90 seconds to cool down the projector lamp.

 **To protect the lamp, the projector will not respond to any commands during the cooling process.**



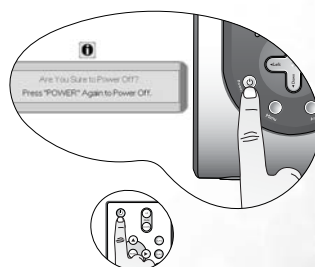

 **Do not unplug the power cord before the projector shutdown sequence is complete or during the 90-second cooling down process.**



Menu operation

Menu system

The OSD menus will vary according to the selected signal type being used.

| Functions available when receiving different signal types... | | |
|---|--|--|
| Sub-Menu | PC | Video / S-Video / Component Video |
|  Picture | Preset Mode Keystone Brightness Contrast | Preset Mode Keystone Brightness Contrast Color Tint |
|  Pro-Picture | Auto Resize Aspect Ratio H Position V Position Phase H. Size | Auto Resize Aspect Ratio Sharpness |
|  Setting | Mute Volume OSD Time Reset Color Temp Password Change Password | |
|  Advance | Mirror Blank Time Source Scan Language Splash Screen High Altitude Mode | |
|  Information | Source Resolution Preset Mode Lamp Hour | Source System Preset Mode Lamp Hour |

Using the menus

The projector is equipped with on-screen display (OSD) menus for making various adjustments and settings.

The following example describes the adjustment of the keystone.

1. Press **Menu** to turn the on-screen menu on.
3. Adjust keystone values by pressing **Left / Right** on the projector or **Left / Right** on the remote control.

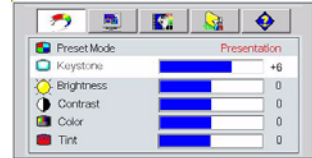
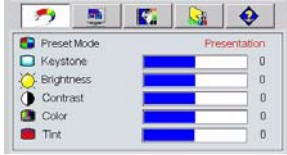



2. Use **Left / Right** on the projector or **Left / Right** on the remote control to select
4. Press **Menu** to leave and save the settings.





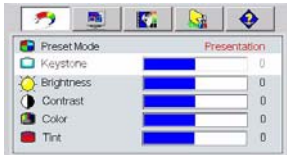

Picture and press **Up** or **Down** to

select **Keystone**.

















There are 10 different menu languages. Before making adjustments, you may choose a suitable OSD language in  **Advance > Language** menu. (Refer to page 27 for more details.)





1. Picture menu

| FUNCTION | DESCRIPTION |
|---------------------------|---|
| <p>Preset Mode</p> | <p>Preset modes are provided so you can optimize your projector image set-up to suit your program type.</p> <p>PC Signal Input</p> <ol style="list-style-type: none"> Presentation Mode: Is designed for presentations. The brightness is emphasized in this mode. Vivid Mode: Is perfect for playing games. The color saturation and brightness are well-balanced. Video Mode: Is suitable for cinematic enjoyment displaying images in their natural color. Economic Mode: Use this mode to reduce system noise and reduce power consumption by 20%. The lamp life is also extended with lower light output. <p>YPbPr/ S-Video/ Video Signal Input</p> <ol style="list-style-type: none"> Gaming Mode: Is suitable for playing video games in a bright living room. Video Mode: With a higher color temperature, it is suitable for enjoying TV movies. Cinema Mode: With a lower color temperature, it is suitable for enjoying cinematic movies. Economic Mode: Use this mode to reduce system noise and reduce power consumption by 20%. The lamp life is also extended with lower light output. |
| <p>Keystone</p> | <p>Corrects any keystone of the image. Refer to page 19 for more information.</p> |
| <p>Brightness</p> | <p>Adjusts the brightness of the image. The higher the value, the brighter the image. And lower the setting, darker the image. Adjust this control so the black areas of the image appear just as black and that detail in the dark areas is visible.</p>  <p>The image shows three examples of a scene with a person's face. Below each image is a horizontal slider with a white bar indicating the current setting. The first slider is at -30, the second at 50, and the third at +70. As the brightness increases, the image becomes lighter and more washed out.</p> |
| <p>Contrast</p> | <p>Adjusts the degree of difference between dark and light in the image. The higher the value, the greater the contrast.</p>  <p>The image shows three examples of the same scene. Below each image is a horizontal slider with a white bar indicating the current setting. The first slider is at -30, the second at 50, and the third at +70. As contrast increases, the dark areas become darker and the light areas become lighter, increasing the overall range of tones.</p> |
| <p>Color</p> | <p>Increases or decreases the color intensity of the image.</p> <p> This function is not available when a PC input is selected.</p> |
| <p>Tint</p> | <p>Adjusts the color tones of the image. The higher the value, the more reddish the image becomes. The lower the value, the more greenish the image becomes.</p> <p> This function is not available when a PC input is selected.</p> |

2. Pro-Picture menu

| FUNCTION | DESCRIPTION |
|---------------------|--|
| Auto Resize | Makes the best fit of the image to the screen. 1. On 2. Off |
| Aspect Ratio | There are two aspect ratio settings. 1. 4 : 3 (Standard) 2. 16 : 9 (Wide screen) |
| H Position | Adjusts the horizontal position of the projected image.  This function is available only when a PC input is selected. <div style="display: flex; justify-content: space-around; align-items: center;"> <div style="text-align: center;">   </div> <div style="text-align: center;">   </div> </div> |
| V Position | Adjusts the vertical position of the projected image.  This function is available only when a PC input is selected. <div style="display: flex; justify-content: space-around; align-items: center;"> <div style="text-align: center;">   </div> <div style="text-align: center;">   </div> </div> |
| Phase | This function allows you to adjust the clock phase to reduce image distortion.  This function is available only when a PC input is selected. <div style="text-align: right; margin-top: 10px;">  </div> |
| H Size | Adjusts the horizontal width of the image.  This function is available only when a PC input is selected. |
| Sharpness | Adjusts the image to make it look sharper or softer.  This function is not available when a PC input is selected. |

3. Setting menu

| FUNCTION | DESCRIPTION |
|------------------------|--|
| Mute | <div style="display: flex; justify-content: space-around; align-items: center;"> <div style="text-align: center;"> <p>Off</p>  </div> <div style="text-align: center;"> <p>On</p>  </div> </div> |
| Volume | <p>Adjusts the volume level.</p>  |
| OSD Time | <p>Sets the length of time the OSD will remain active after your last button press. The range is from 5 to 60 seconds.</p> |
| Reset | <p>Returns all settings to the factory preset values.</p> |
| Color Temp | <p>Adjusts the color temperature*. To make images appearing bluish white, press ▶ to raise the color temperature. On the contrary, to make images appearing reddish white, press ◀ to lower the color temperature.</p> <p>*About color temperatures: There are many different shades that are considered to be “white” for various purposes. One of the common methods of representing white color is known as the “color temperature”. A white color with a low color temperature appears to be reddish white. A white color with a high color temperature appears to have more blue in it.</p> |
| Password | <p>This is a selectable function. Selecting ✓ limits use of the projector to only those who know the correct password. When the function is activated for the first time, you have to set a password for it. For more information, refer to page 17. Once the password is set and this function is selected, the projector is password-protected. Users who do not know the correct password can not use the projector.</p> <p> WARNING: You will be inconvenienced if you activate the password functionality and subsequently forget the password. Write the password you used in this manual, and keep the manual in a safe place for later recall.</p> <p>The password can be entered by using either the buttons on the projector or the remote control.</p> |
| Change Password | <p>You will be asked to enter the current password before changing to a new one. For more information, refer to page 17.</p> |

4. Advance menu

| FUNCTION | DESCRIPTION |
|---------------------------|---|
| Mirror | <p>The projector can be installed on a ceiling or behind a screen, or with one or more mirrors. Contact your dealer for the ceiling mount bracket (optional accessory) if you need to install the projector on your ceiling.</p> <p>For more information, refer to page 11.</p> |
| Blank Time | <p>Sets the image blank time when the Blank feature is activated, once elapsed the image will return to the screen.</p> |
| Source Scan | <p>Sets whether the projector searches automatically for input signals. If the source scan is on (✓), the projector will scan for input signals until it acquires a signal. If the function is not activated, the projector selects the last used input signal.</p> |
| Language | <p>Language sets the language for the OSD control menus.</p> <p>Use ◀ Left/ Right ▶ on the projector or ◀ / ▶ on the remote control to select your desired language from among English, French, German, Italian, Spanish, Russian, Traditional Chinese, Simplified Chinese, Japanese, and Korean.</p> |
| Splash Screen | <p>Enables the user to select which logo screen will appear during projector start-up. Three modes are available: Default (BenQ logo), black screen or blue screen.</p> |
| High Altitude Mode | <p>A mode for extreme environments like high altitude and high temperature. We recommend you use the High Altitude Mode when your environment is higher than 3000 feet above sea level, and is hotter than 40°C.</p> <p>To activate the High Altitude Mode, select ✓ by pressing ◀ or ▶ on the projector or remote control. A confirmation message displays. Press Auto.</p> <div data-bbox="351 914 1012 1042" style="border: 1px solid gray; padding: 10px; margin: 10px 0;"> <p style="text-align: center; color: red;">We recommend you use the High Altitude Mode by selecting ✓ when your environment is higher than 3000 feet, and is hotter than 40°C.</p> <p style="text-align: center; color: blue;">Do you want to turn on High Altitude Mode?</p> <p style="text-align: center;">Yes Auto No ▲</p> </div> <p>Next time you turn on the projector, it will show a message pictured below as a reminder during the start-up.</p> <div data-bbox="351 1107 1012 1230" style="border: 1px solid gray; padding: 10px; margin: 10px 0;"> <p style="text-align: center; color: red;">Current Status</p> <p style="text-align: center; color: blue;">High Altitude Mode On</p> <p style="text-align: center; color: blue; font-size: small;">This mode is used for protecting projector from extreme environment and may cause high fan speed.</p> </div> <p>Operation under "High Altitude Mode" may cause a higher decibel operating noise level because of increased fan speed necessary to improve overall system cooling and performance.</p> <p>If you use this projector under other extreme environments excluding the above, it may display auto shut-down symptoms, which is designed to protect your projector from over-heating. In cases like this, you should switch to High Altitude mode to solve these symptoms. However, this is not to state that this projector can operate under any and all harsh or extreme environments.</p> |

5. Information Menu

This menu shows you the current operating status of the projector.

| FUNCTION | DESCRIPTION |
|--------------------|---|
| Source | Shows the current signal source. |
| Resolution | Shows the native resolution of the input signal. |
| Preset Mode | Shows the selected mode in  Picture menu. |
| Lamp Hour | Displays the number of hours the lamp has been used. |
| System | Shows the Video input system format, NTSC, SECAM or PAL. |

6 Maintenance

Care of the projector

Your projector needs little maintenance. The only thing you need to do on a regular basis is to keep the lens clean.

Never remove any parts of the projector except the lamp. Contact your dealer if other parts need replacing.

Cleaning the lens

Clean the lens whenever you notice dirt or dust on the surface.

- Use a canister of compressed air to remove dust.
- If there is dirt or smears, use lens-cleaning paper or moisten a soft cloth with lens cleaner to gently wipe the lens surface.

 **Never rub the lens with abrasive materials.**

Cleaning the projector case

Before you clean the case, turn the projector off and unplug the power cord.

- To remove dirt or dust, wipe the case with a soft, dry, lint-free cloth.
- To remove stubborn dirt or stains, moisten a soft cloth with water and a neutral pH detergent. Then wipe the case.

 **Never use wax, alcohol, benzene, thinner or other chemical detergents. These can damage the case.**

Storing the projector

If you need to store the projector for an extended time, please follow the instructions below.

- Make sure the temperature and humidity of the storage area are within the recommended range for the projector. Please refer to the Spec. page (36) in the manual or consult your dealer about the range.
- Retract the adjuster feet.
- Remove the batteries from the remote control.
- Pack the projector in its original packing or equivalent.

Transporting the projector

It is recommended that you ship the projector with its original packing or equivalent. When you carry the projector yourself, please use the provided soft carry case.

Lamp information



Warning message

When the **Lamp indicator** lights up red or a message appears suggesting it is time to replace the lamp, please install a new lamp. An old lamp may cause a malfunction in the projector and in some instances the lamp may break.

For more detailed information on lamp warnings, please refer to page 32.

 **The Lamp indicator light and Temperature warning light will light up if the lamp becomes too hot. Turn the power off and let the projector cool for 45 minutes. If the Lamp or Temp indicator still lights up after turning the power back on, please contact your dealer.**

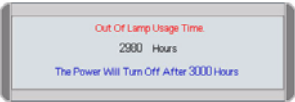
The following Lamp warning displays will remind you to change the lamp. The lamp hour information is also available in  **Information > Lamp Hour** menu.

| Message | Status |
|---|---|
|  <p>Lamp Warning 1980 Hours Change Lamp If Brightness Is Low</p> | <p>The lamp has been in operation for 1980 hours. Install a new lamp for optimal performance. If the projector is normally run with Preset "Economic Mode" selected (page 24), you may continue to operate the projector until the 2980 hour lamp warning appears.</p> |
|  <p>Out Of Lamp Usage Time 2980 Hours The Power Will Turn Off After 3000 Hours</p> | <p>The lamp has been in operation for 2980 hours, the power will shutdown in 20 hours time. A new lamp should be fitted to avoid the inconvenience when the projector runs out of lamp time.</p> |
|  <p>Out Of Lamp Usage Time 3000 Hours Change The Lamp!</p> | <p>The lamp has been in operation for over 3000 hours. This message will flash in the center of the screen together with the Lamp indicator lighting up red for 40 seconds. The projector will shutdown after 40 seconds. The lamp MUST be replaced before the projector will operate normally.</p> |

Replacing the lamp

 **To reduce the risk of electrical shock, always turn the projector off and disconnect the power cord before changing the lamp.**

To reduce the risk of severe burns, allow the projector to cool for at least 45 minutes before replacing the lamp.

To reduce the risk of injuries to fingers and damage to internal components, use caution when removing lamp glass that has shattered into sharp pieces.

To reduce the risk of injuries to fingers and/or compromising image quality by touching the lens, do not touch the empty lamp compartment when the lamp is removed.

This lamp contains mercury. Consult your local hazardous waste regulations to dispose of this lamp in a proper manner.

- Step 1. Turn the power off and disconnect the projector from the wall socket.
- Step 2. Protect the projector's surface by clearing a flat open area on your desk and placing a soft item on the desk for padding.
- Step 3. Turn the projector over. Then loosen the screws and remove the lamp cover. If the lamp is hot, avoid burns by waiting for 45 minutes until the lamp has cooled.

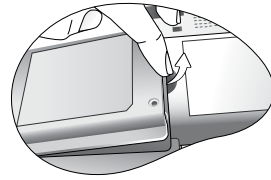
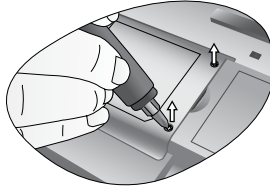

- Step 4. Loosen the screw fixing the lamp to the projector. If the screw is not loosened completely, the lamp cannot be removed. Be careful not to lose the screw as it is needed to hold the replacement lamp in place. It is strongly recommended that you use a magnetic-head screwdriver.

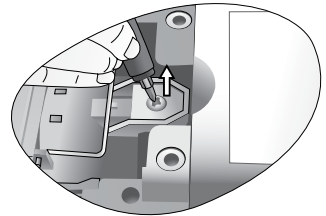

- Step 5. Lift the handle so that it stands up. Use the handle to slowly pull the lamp out of the projector.

 **Pulling it too quickly may cause the lamp to break and scatter broken glass in the projector.**

 **Do not place the lamp in locations where water might splash on it, children can reach it, or near flammable materials.**

 **Do not insert your hands into the projector after the lamp is removed. If you touch the optical components inside, it could cause color unevenness and distortion of the projected images.**

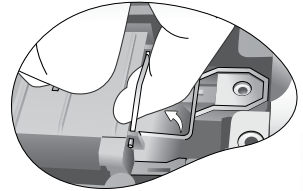

- Step 6. Insert a new lamp. Ensure the handle is fully laid flat and locked in place. Reinsert and tighten the screw firmly.

 **Loose screw may cause a bad connection, which could result in malfunction.**

 **Do not over tighten the screw.**

- Step 7. Reinstall the lamp cover and tighten the screws.

- Step 8. Restart the projector.

 **Do not turn the power on with the lamp cover removed.**

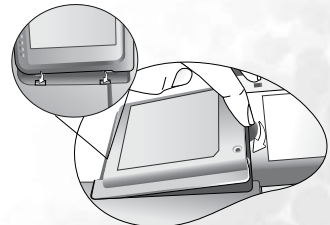

Step 9. Resetting the lamp counter

 **Do not reset if the lamp is not replaced as this could cause damage.**

- i. Press and hold the **▲** button on the projector for 5 seconds to display the total used lamp time.
- ii. Press **Auto** on the projector or on the remote control to access the lamp hour timer. An adjustment message will appear.
- iii. Press **◀** or **▶** to reset lamp hours and press **Auto** to reset.

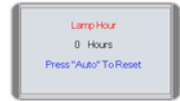

Temperature information

When the Temperature warning light flashes, it is warning you of the following possible problems:



1. The internal temperature is too high.
2. The fans are not working.





Turn the projector off and contact qualified service personnel for further help.

























For more detailed information, please refer to **Indicators** below.

Indicators

Illustration

1. Blank - : Light OFF
2.  : Light flashing
3.  : Light ON
4. **O** : Orange light
5. **R** : Red light
6. **G** : Green light

| Light | | | Status & Description |
|---|---|---|---|
| Power | Temp | Lamp | |
| Power events | | | |
|  |  |  | The projector has just been connected to a power outlet. |
|  | - | - | The projector needs to cool for 90 seconds after the power is turned off. |
|  | - | - | Stand-by mode. |

| | | | |
|---|---|---|--|
|  | - | - | The Power indicator light is flashing during powering up. |
|  | - | - | The projector is under normal operation. |
| Lamp events | | | |
| - | - |  | It is warning you that lamp usage has exceeded 2000 / 3000 (Economic mode) hours. Replace the projection lamp with a new one immediately. |
| - | - |  | The lamp is not properly attached or the lamp is damaged. Please contact your dealer for assistance. |
| Thermal events | | | |
|  |  | - | The projector has shutdown automatically. If you try to re-start the projector, it will shutdown again. Please contact your dealer for assistance. |
|  |  |  | The projector has shutdown automatically. If you try to re-start the projector, it will shutdown again. Please contact your dealer for assistance. |
|  |  |  | The projector has shutdown automatically. If you try to re-start the projector, it will shutdown again. Please contact your dealer for assistance. |
|  |  | - | The projector has shutdown automatically. If you try to re-start the projector, it will shutdown again. Please contact your dealer for assistance. |
|  |  |  | The projector has shutdown automatically. If you try to re-start the projector, it will shutdown again. Please contact your dealer for assistance. |
|  |  |  | The projector has shutdown automatically. If you try to re-start the projector, it will shutdown again. Please contact your dealer for assistance. |
| - |  | - | The projector has shutdown automatically. If you try to re-start the projector, it will shutdown again. Please contact your dealer for assistance. |
| - |  |  | The projector has shutdown automatically. If you try to re-start the projector, it will shutdown again. Please contact your dealer for assistance. |
| - |  |  | The projector has shutdown automatically. If you try to re-start the projector, it will shutdown again. Please contact your dealer for assistance. |

Service information

Accessories (included in the standard package)

| Description | Part Number |
|---------------------------|--------------------|
| Signal cable..... | 50.J0508.503 |
| Video cable..... | 50.J1303.501 |
| S-Video cable..... | 50.72920.011 |
| RCA R/W audio cable..... | 50.J1311.001 |
| PC - PC audio cable | 50.L4302.501 |
| Soft carry case | 98.J2202.001 |
| USB mouse cable..... | 50.73213.501 |
| Remote control | 56.26J93.001 |

Alternative accessories (vary by regions)

| | |
|------------------------|--------------|
| Power cord (US) | 27.01818.000 |
| Power cord (EU) | 27.82718.281 |
| Power cord (UK)..... | 27.01018.000 |
| 3-2 power adaptor..... | 22.91007.001 |

Optional accessories (not included in the standard package)

| Description of parts | Partnumber |
|-----------------------------------|-------------------|
| Mac adapter (switchable) | 20.20118.A15 |
| 200W lamp module | 60.J9301.CG1 |
| Ceiling mount kit..... | 60.J9319.001 |
| Wireless Pro (EU) | 59.J8201.001 |
| Wireless Pro (US)..... | 59.J8201.002 |
| Presentation Plus | 65.J9306.001 |
| Component Video cable | 50.J2401.001 |

Ordering parts or getting information

For product information, product assistance, service information, or to order accessories, please visit the BenQ Corporation website at <http://www.BenQ.com>.

7 Troubleshooting

② THE PROJECTOR DOES NOT TURN ON.

| Cause | Remedy |
|---|--|
| There is no power from the power cable. | Plug the power cord into the AC inlet on the projector, and plug the power cord into the power outlet. If the power outlet has a switch, make sure that it is switched on. |
| Attempting to turn the projector on again during the cooling process. | Wait until the cooling down process has completed. |

② NO PICTURE

| Cause | Remedy |
|--|--|
| The video source is not turned on or connected correctly. | Turn the video source on and check that the signal cable is connected correctly. |
| The projector is not correctly connected to the input source device. | Check the connection. |
| The input signal has not been correctly selected. | Select the correct input signal with the Source key on the projector or remote control. |
| The lens cap is still attached to the lens. | Remove the lens cap. |

② BLURRED IMAGE

| Cause | Remedy |
|--|---|
| The projection lens is not correctly focused. | Adjust the focus of the lens using the focus ring. |
| The projector and the screen are not aligned properly. | Adjust the projection angle and direction as well as the height of the unit if necessary. |
| The lens cap is still attached to the lens | Remove the lens cap. |

② REMOTE CONTROL DOES NOT WORK

| Cause | Remedy |
|--|---|
| The battery is out of power. | Replace the battery with new ones. |
| There is an obstacle between the remote control and the projector. | Remove the obstacle. |
| You are too far away from the projector. | Stand within 6 meters (~ 20 feet) of the projector. |

8 Specifications

Projector specifications

 All specifications are subject to change without notice.

General

| | |
|--------------|-----------------------|
| Product name | Digital Projector |
| Model name | PB2250 1024 x 768 XGA |

Optical

| | |
|----------------|---|
| Display system | 1-CHIP DMD |
| Lens F/Number | PB2250 F=2.4 to 2.6, f= 18.6 to 22.7 mm |
| Lamp | 200W lamp |

Electrical

| | |
|-------------------|--|
| Power supply | AC100 ~ 240V, 3.5A, 50/60 Hz (Automatic) |
| Power consumption | 265W (Max) |

Mechanical

| | |
|-----------------------------|---------------------------------------|
| Dimensions | 238 mm (W) x 86.8 mm (H) x 180 mm (D) |
| Operating temperature range | 0°C ~ 40°C |
| Weight | 4.2 lbs (1.9 Kg) |

Input terminal

| | |
|--------------------|--|
| Computer input | |
| RGB input | D-sub 15-pin (female) |
| Video signal input | |
| S-VIDEO | Mini DIN 4-pin port x 1 |
| VIDEO | RCA x 1 |
| HDTV signal input | D-sub <--> YPbPr RCA jack x 3, through RGB input |
| Audio signal input | |
| Audio in | Mini jack stereo socket |

Output

| | |
|---------------------|----------------|
| USB mouse connector | A/B series x 1 |
| Speaker | 1 watt x 1 |

Environmental requirements

| | |
|-----------------------------|--|
| Operating temperature | 0°C ~ 40°C at sea level |
| Operating relative humidity | 10% ~ 90% (without condensation) |
| Operating altitude | 1830 meters (6000 feet) at 30°C |
| | 1830 ~ 3050 meters (6000 ~ 10000 feet) at 23°C |

Dimensions

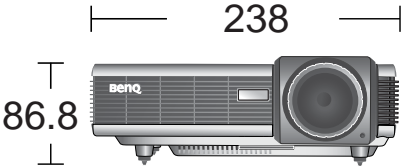

Unit: mm

Timing chart

Supported timing for PC input

| Resolution | Horizontal Frequency (kHz) | Vertical Frequency (Hz) | Pixel Frequency (MHz) | Mode |
|------------------------|----------------------------|-------------------------|-----------------------|--------------|
| 720 x 400 | 37.927 | 85.039 | 35.500 | 720 x 400_85 |
| 640 x 480 | 31.469 | 59.940 | 25.175 | VGA_60 |
| | 37.861 | 72.809 | 31.500 | VGA_72 |
| | 37.500 | 75.000 | 31.500 | VGA_75 |
| | 43.269 | 85.008 | 36.000 | VGA_85 |
| 800 x 600 | 37.879 | 60.317 | 40.000 | SVGA_60 |
| | 48.077 | 72.188 | 50.000 | SVGA_72 |
| | 46.875 | 75.000 | 49.500 | SVGA_75 |
| | 53.674 | 85.061 | 56.250 | SVGA_85 |
| 1024 x 768 (native) | 48.363 | 60.004 | 65.000 | XGA_60 |
| | 56.476 | 70.069 | 75.000 | XGA_70 |
| | 60.023 | 75.029 | 78.750 | XGA_75 |
| | 68.667 | 84.997 | 94.500 | XGA_85 |
| 1280 x 1024 | 63.981 | 60.020 | 108.000 | SXGA3_60 |

 To achieve the best quality projected image, please use the projector's native resolution of 1024 x 768.

Supported timing for Component-YPbPr Input

| Signal Format | Horizontal Frequency (kHz) | Vertical Frequency (Hz) |
|-------------------|----------------------------|-------------------------|
| 480i(525i)@60Hz | 15.73 | 59.94 |
| 480p(525p)@60Hz | 31.47 | 59.94 |
| 576i(625i)@50Hz | 15.63 | 50.00 |
| 576p(625p)@50Hz | 31.25 | 50.00 |
| 720p(750p)@60Hz | 45.00 | 60.00 |
| 720p(750p)@50Hz | 37.50 | 50.00 |
| 1080i(1125i)@60Hz | 33.75 | 60.00 |
| 1080i(1125i)@50Hz | 28.13 | 50.00 |

Supported timing for Video and S-Video inputs

| Video mode | Horizontal Frequency (kHz) | Vertical Frequency (Hz) | Color sub-carrier Frequency (MHz) |
|------------|----------------------------|-------------------------|-----------------------------------|
| NTSC | 15.73 | 60 | 3.58 |
| PAL | 15.63 | 50 | 4.43 |
| SECAM | 15.63 | 50 | 4.25 or 4.41 |
| PAL-M | 15.73 | 60 | 3.58 |
| PAL-N | 15.63 | 50 | 3.58 |
| PAL-60 | 15.73 | 60 | 4.43 |
| NTSC4.43 | 15.73 | 60 | 4.43 |

Warranty

Limited warranty

BenQ warrants this product against any defects in material and workmanship, under normal usage and storage.

Proof of purchase date will be required with any warranty claim. In the event this product is found to be defective within the warranty period, BenQ's only obligation and your exclusive remedy shall be replacement of any defective parts (labor included). To obtain warranty service, immediately notify the dealer from which you purchased the product of any defects.

Important: The above warranty shall be void if the customer fails to operate the product in accordance with BenQ's written instructions, especially the ambient humidity must be in-between 10% and 90%, temperature in-between 0°C and 40°C, altitude lower than 10000 feet, and avoiding to operate the projector in a dusty environment. This warranty gives you specific legal rights, and you may have other rights which vary from country to country.

For other information, please refer to BenQ Warranty Information Book.

10 Regulation statements

FCC statement

CLASS B: This equipment generates, uses and can radiate radio frequency energy and, if not installed and used in accordance with the instructions, may cause harmful interference to radio communications. However, there is no guarantee that interference will not occur in a particular installation. If this equipment does cause harmful interference to radio or television reception, which can be determined by turning the equipment off and on, the user is encouraged to try to correct the interference by one or more of the following measures:

- Reorient or relocate the receiving antenna.
- Increase the distance between the equipment and receiver.
- Connect the equipment into an outlet on a circuit different from that to which the receiver is connected.
- Consult the dealer or an experienced radio/TV technician for help.

EEC statement

This machine was tested against the 89/336/EEC (European Economic Community) for EMC (Electronic Magnetic Compatibility) and fulfills these requirements.

MIC statement

B class equipment (Household purpose info/telecommunications equipment)

As this equipment has undergone EMC registration for household purpose, this product can be used in any area including residential area.