



DLP PROJECTOR PB2220/ PB2120

USER'S GUIDE

Thank you for purchasing the BenQ DLP Projector.

Please read this user's guide to ensure correct use of the device. Save this user's guide for future reference.

OUTLINE

This DLP projector can display various computer signals and NTSC/PAL/SECAM video signals.

FEATURES

- 1. High Brightness**
- 2. High Resolution**
- 3. Compact Size, Feather Weight for Portability**
- 4. Durable Magnesium Alloy Body**
- 5. RGB Input Terminal**
- 6. One Touch Auto-Adjustment Function**
- 7. Easy Keystone Adjustment**

Copyright

Copyright © 2003 by BENQ Corporation. All rights reserved. No part of this publication may be reproduced, transmitted, transcribed, stored in a retrieval system or translated into any language or computer language, in any form or by any means, electronic, mechanical, magnetic, optical, chemical, manual or otherwise, without the prior written permission of BENQ Corporation.

Disclaimer

BENQ Corporation makes no representations or warranties, either expressed or implied, with respect to the contents hereof and specifically disclaims any warranties, merchantability or fitness for any particular purpose. Furthermore, BENQ Corporation reserves the right to revise this publication and to make changes from time to time in the contents hereof without obligation of BENQ Corporation to notify any person of such revision or changes.

Fill this in!!	
For future service convenience, record the following information in the space below. The serial number is on the back of the product.	
Projector Information	
Product Name:	PB2220/ PB2120
Serial Number:	
Date of Purchase:	
Dealer Information	
Dealer:	
Telephone Number:	
Address:	

Table of Contents

Important Safety Instructions	1
Introduction	3
Shipping Contents	3
Projector Descriptions	4
Your Projector at a Glance	4
Adjuster	6
Projector Features	6
Remote Control Description	7
Your Remote Control at a Glance	7
Remote Control Effective Range	7
Remote Control Features	8
Installing or Replacing Batteries	9
Installation	10
Screen Size	10
Connecting to Various Equipment	11
Operation	12
Start Up	12
Digital Keystone Correction	13
Auto Adjustment	13
Source Selection	14
Menu System	14
1. Display Menu	15
2. Image Menu	16
3. Source Menu	17
4. Control Menu	18
5. PIP Menu	18
Shutdown	19
Maintenance	20
Lamp Information	20
Use and Replacement of Lamp	20
LED Status Indicators	20
Lamp Replacement	21

Resetting Lamp Hours	22
Service Information	23
Accessories (Included in the standard package)	23
Optional Accessories (Not included in the standard package)	23
Ordering Parts or Getting Information	23
Troubleshooting	24
Common Problems & Solutions	24
Status Messages	25
Specifications	26
Projector Specifications	26
Timing Chart	27
Dimensions	28
Warranty	29
Limited Warranty	29
Safety Regulations	30
FCC Statement	30
EEC Statement	30

IMPORTANT SAFETY INSTRUCTIONS

⚠ CAUTION

- **To prevent shock, do not open the cabinet.** No user-serviceable parts inside.

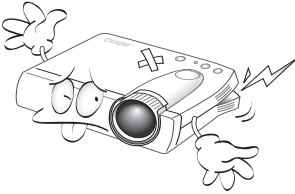

- **Please read this user's guide before you operate your projector.** Save this user's guide for future reference.

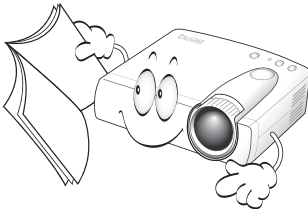

- **Do not look straight at the projector lens during operation.** The intense light beam may damage your eyes.

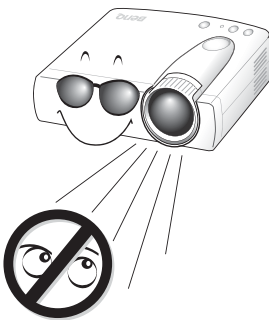

- **Refer servicing to qualified service personnel.**

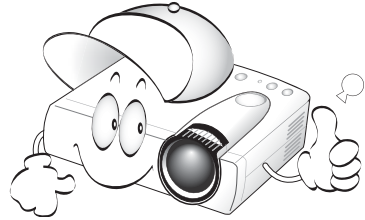

- **Always open the lens shutter or remove the lens cap when the projector lamp is on.**

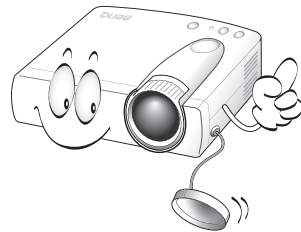

- In some countries, the line voltage is NOT stable. This projector is designed to operate safely within a bandwidth of 110 to 240 volts, but could fail if power cuts or surges of ± 10 volts occur. **In these high-risk areas, it is recommended to install a power stabilizer unit.**

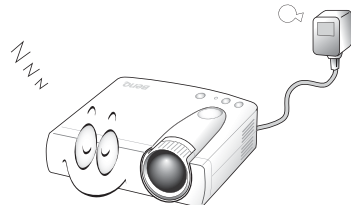

SAFETY INSTRUCTIONS

1. The lamp becomes extremely hot during operation. Allow the projector to cool for approximately 45 minutes prior to removing the lamp assembly for replacement.

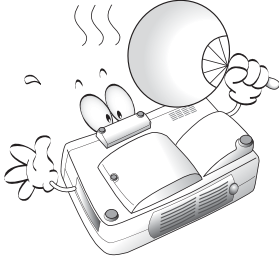

2. Do not operate lamps beyond the rated lamp life. Excessive operation of lamps beyond the rated life could cause them to explode on rare occasions.

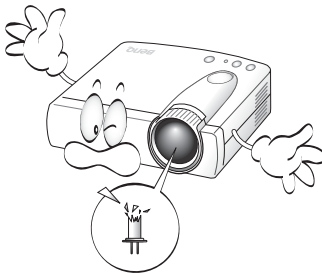

3. Never replace lamp assembly or any electronic components unless the projector is unplugged.

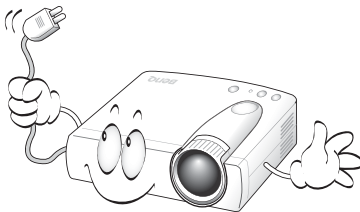

4. Do not place this product on an unstable cart, stand, or table. The product may fall, sustaining serious damage.

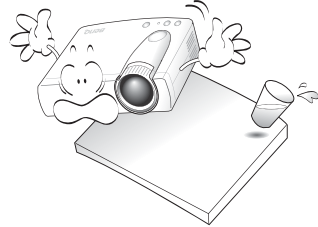

5. To reduce the risk of electric shock, do not disassemble this appliance.

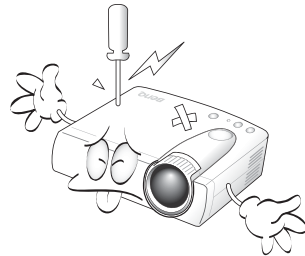

*Take it to a qualified technician when service or repair is required. Incorrect reassembly can cause electric shock when the appliance is subsequently used.

6. This product is capable of displaying inverted images for ceiling mount installation. Please use BenQ's Ceiling Mounting Kit for mounting the unit and ensure it is securely installed.

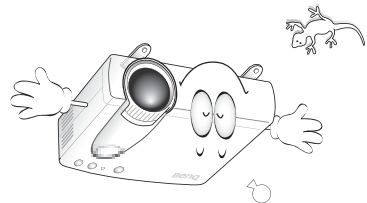

INTRODUCTION

Shipping Contents

The projector is shipped with the necessary cables required for standard PC or laptop computer connections. Carefully unpack and verify that you have all the items shown below. If any of these items are missing, please contact your place of purchase.



Projector



User's Guide



Quick Start Guide



Warranty Book



Remote Control

Battery

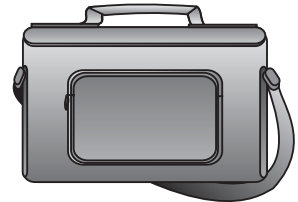

Soft Carrying Case



3-2 Converter



User's Manual CD

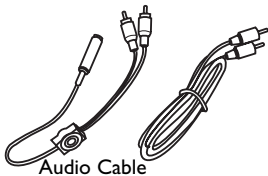

Audio Cable

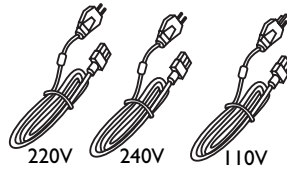

220V

240V

110V

Power Cord

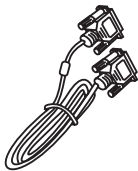

VGA Cable

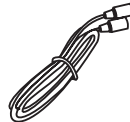

S-Video Cable

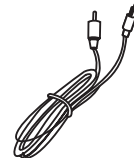

Video Cable

Optional Accessories

1. Spare lamp kit
2. Macintosh adaptor
3. HDTV cable
4. Ceiling mount kit
5. Presentation wizard kit

Projector Descriptions

Your Projector at a Glance

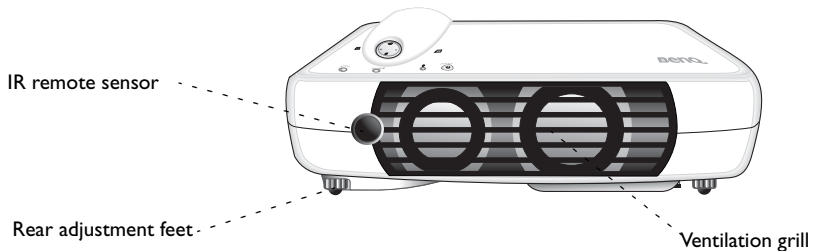
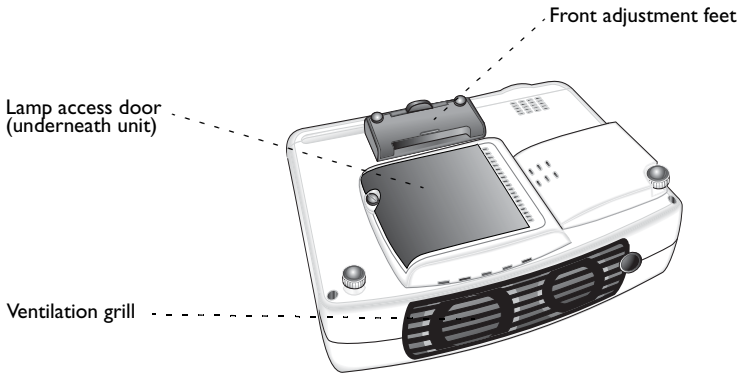
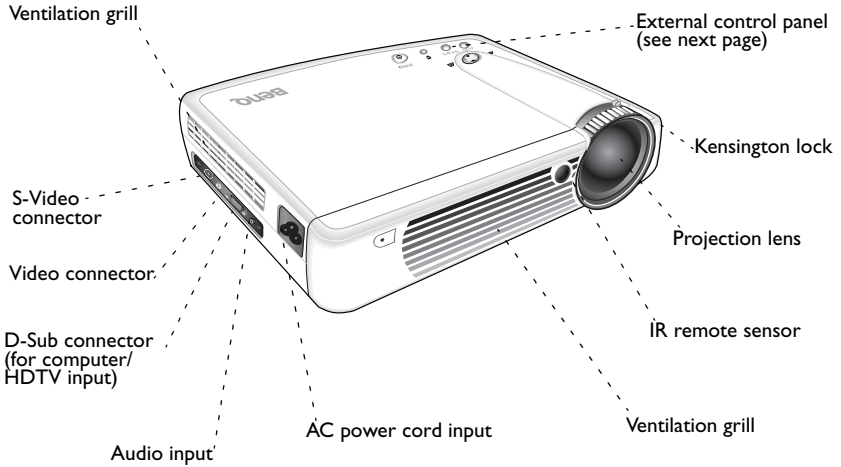

External Control Panel

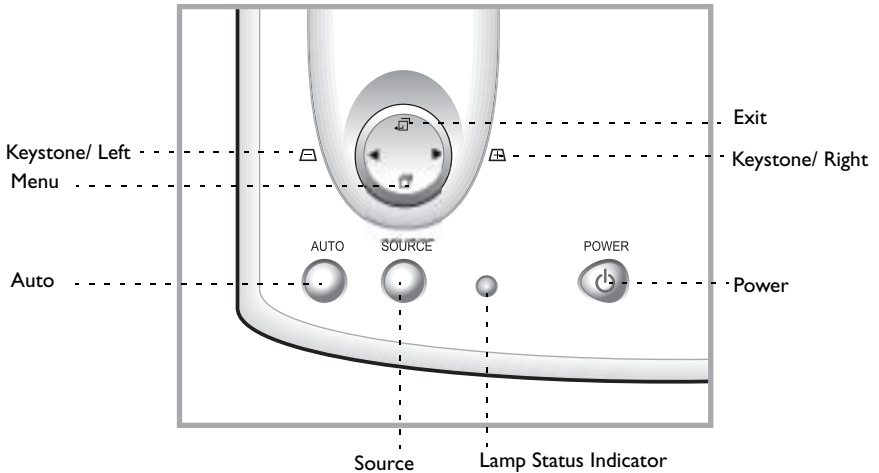

- Press and hold **Power** for 1 second to turn the projector on or off.
- When the projector is on, **Back-lit Power** will blink during warm-up and turn to solid green to indicate the projector is ready for use.
- The **Infrared Remote Receiver (Front and Rear)** allows the projector to accept signals from the remote control. For best results, be sure to aim the control toward the sensor without any obstructions between the two, and at a distance no greater than 6 meters.
- **Menu** will display the menu system on screen. Press **Menu** again to access the sub-menus. **Left** and **Right** help you navigate among choices and settings in the menus and sub-menus. However, when the on screen menu is not activated, the **Left** and **Right** buttons will function as **Keystone +/-** hot keys.
- Press the **Exit** button to go back to the main menu. Press **Exit** again to leave the menu system.
- The **Lamp Status Indicator** will flash or light up when the lamp needs service, cooling or replacement. See “Lamp Information” on page 20 for more detailed information.
- **Auto** key: Automatically sense the best picture quality for current received signals.
- **Source** key: Select signal sources from among PC, Video, S-Video and YPbPr, when several input sources are available.

Adjuster

The projector is equipped with a quick-release adjuster foot and button for adjusting its tilt angle.

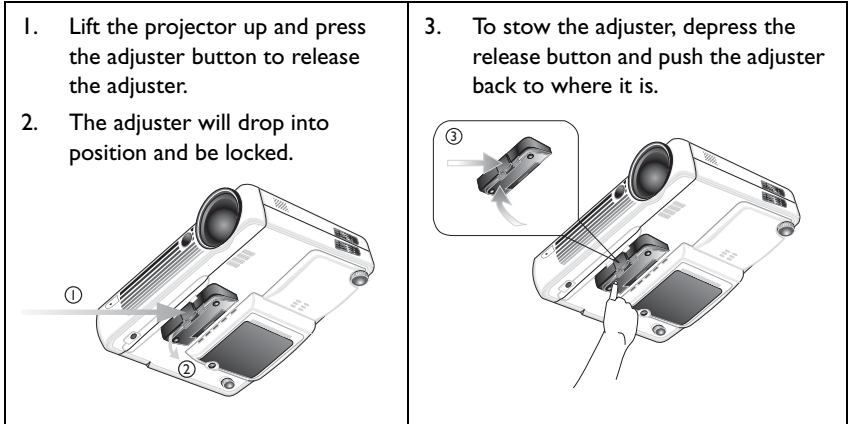

Projector Features

The projector integrates high performance optical engine projection and user-friendly design to deliver high reliability and ease of use.

The Projector offers the following features:

- Compact and portable unit
- Full-function remote control
- Manual zoom lens
- One key auto-adjustment to display the best picture quality
- Easy digital keystone correction through hot keys to correct tilted pictures
- Adjustable color balance control for data/video
- Ultra-high brightness projection lamp
- Ability to display high quality 16.7 million colors
- On screen menus in 8 languages: English, French, German, Italian, Spanish, Korean, Simplified Chinese, and Traditional Chinese.
- Powerful AV function to provide high AV picture results.
- HDTV compatibility (YPbPr)

Note: The brightness of your machine will vary depending on the ambient room conditions and contrast/brightness settings.

Remote Control Description

Your Remote Control at a Glance

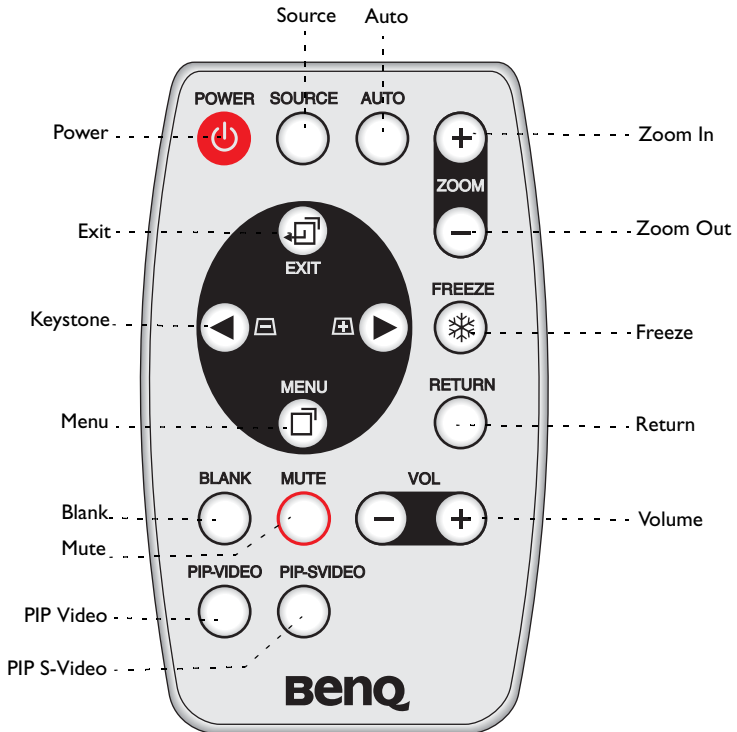

Remote Control Effective Range

The remote sensors are located on the front and the back of the projector. It can function in a range of 30 degrees horizontally and 30 degrees vertically relative to a line that is a right angle to the remote sensors. The distance between the remote control and the remote sensors must be shorter than 6 meters (19.5 feet).

Remote Control Features

FREEZE

The image can be frozen when FREEZE is pressed. An icon  will appear in the lower right corner of the screen for three seconds. To release the freeze function, press the FREEZE button, RETURN button or SOURCE button (when the input source is switched over during display) again. A "Play" icon will appear in the lower right corner of the screen for three seconds when the freeze function is released.

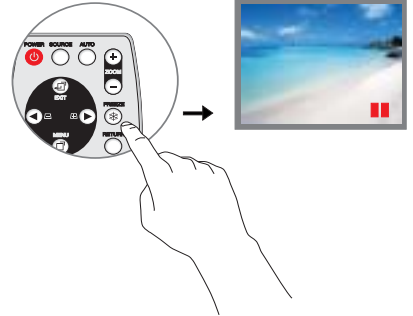

ZOOM IN/OUT

By pressing ZOOM +, the center of the picture will be magnified. When the + button is pressed again, the picture is further magnified, up to four times the original size. By pressing ZOOM —, the size of the image is reduced. When the - button is pressed again, the picture is further reduced until it is restored to its original size. To return to the normal display mode, press the RETURN button. (This function can be used in combination with FREEZE.)

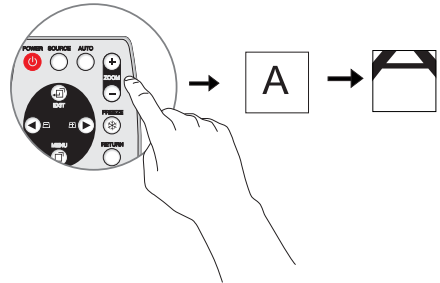

Installing or Replacing Batteries

1. Use a pointy-sided stick to release the battery tray. Pull the tray off.

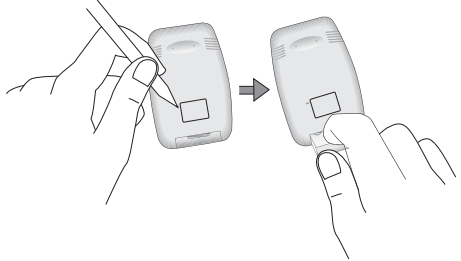

2. Install or replace a battery.

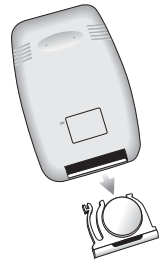

3. Snap the battery tray back into place.

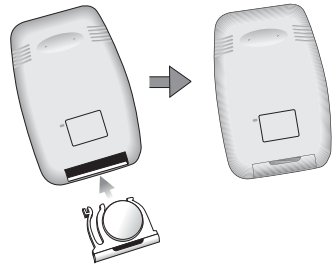

Caution

Avoid excessive heat and humidity. There may be danger of an explosion if a battery is incorrectly replaced. Replace only with the same or equivalent type recommended by the manufacturer. Dispose of used batteries according to the manufacturer's instructions.

INSTALLATION

Screen Size

Place the projector at the required distance from the screen according to the desired picture size (see the table below).

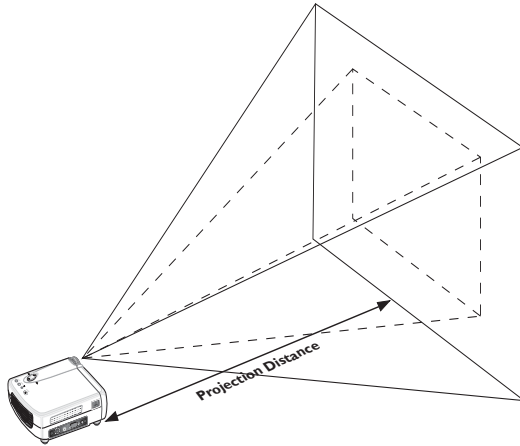

- PB2220 (XGA) screen size chart

Distance from screen		Diagonal measurement			
		Minimum zoom		Maximum zoom	
feet	inches	feet	inches	feet	inches
4	48	2.49	29.9	3.05	36.6
6	72	3.73	44.8	4.57	54.9
8	96	4.98	59.7	6.10	73.2
10	120	6.22	74.7	7.62	91.4
12	144	7.47	89.6	9.14	109.7
14	168	8.71	104.5	10.67	128.0
16	192	9.96	119.5	12.19	146.3
18	216	11.20	134.4	13.72	164.6
20	240	12.45	149.4	15.24	182.9
22	264	13.69	164.3	16.76	201.2
24	288	14.94	179.2	18.29	219.5
26	312	16.18	194.2	19.81	237.7
28	336	17.42	209.1	21.34	256.0
30	360	18.67	224.0	22.86	274.3
32	384	19.91	239.0	24.38	292.6

Distance from screen		Diagonal measurement			
		Minimum zoom		Maximum zoom	
meters	cm	meters	cm	meters	cm
1	100	0.62	62.2	0.76	76.2
1.5	150	0.93	93.3	1.14	114.3
2	200	1.24	124.5	1.52	152.4
2.5	250	1.56	155.6	1.91	190.5
3	300	1.87	186.7	2.29	228.6
3.5	350	2.18	217.8	2.67	266.7
4	400	2.49	248.9	3.05	304.8
4.5	450	2.80	280.0	3.43	342.9
5	500	3.11	311.2	3.81	381.0
5.5	550	3.42	342.3	4.19	419.1
6	600	3.73	373.4	4.57	457.2
6.5	650	4.04	404.5	4.95	495.3
7	700	4.36	435.6	5.33	533.4
7.5	750	4.67	466.7	5.72	571.5
8	800	4.98	497.8	6.10	609.6

- PB2120 (SVGA) screen size chart

Distance from screen		Diagonal measurement			
		Minimum zoom		Maximum zoom	
feet	inches	feet	inches	feet	inches
4	48	1.96	23.5	2.40	28.7
6	72	2.93	35.2	3.59	43.1
8	96	3.91	47.0	4.79	57.5
10	120	4.89	58.7	5.99	71.9
12	144	5.87	70.4	7.19	86.2
14	168	6.85	82.2	8.39	100.6
16	192	7.83	93.9	9.58	115.0
18	216	8.80	105.7	10.78	129.4
20	240	9.78	117.4	11.98	143.7
22	264	10.76	129.1	13.18	158.1
24	288	11.74	140.9	14.37	172.5
26	312	12.72	152.6	15.57	186.9
28	336	13.70	164.3	16.77	201.2
30	360	14.67	176.1	17.97	215.6
32	384	15.65	187.8	19.17	230.0

Distance from screen		Diagonal measurement			
		Minimum zoom		Maximum zoom	
meters	cm	meters	cm	meters	cm
1	100	0.49	48.9	0.60	59.9
1.5	150	0.73	73.4	0.90	89.8
2	200	0.98	97.8	1.20	119.8
2.5	250	1.22	122.3	1.50	149.7
3	300	1.47	146.7	1.80	179.7
3.5	350	1.71	171.2	2.10	209.6
4	400	1.96	195.7	2.40	239.6
4.5	450	2.20	220.1	2.70	269.5
5	500	2.45	244.6	2.99	299.5
5.5	550	2.69	269.0	3.29	329.4
6	600	2.93	293.5	3.59	359.4
6.5	650	3.18	317.9	3.89	389.3
7	700	3.42	342.4	4.19	419.3
7.5	750	3.67	366.8	4.49	449.2
8	800	3.91	391.3	4.79	479.1

Connecting to Various Equipment

It only takes a few seconds to connect your projector to your computer/notebook, VCR or other systems. However, a Mac adapter (an optional accessory) is needed for connection for Macintosh users.

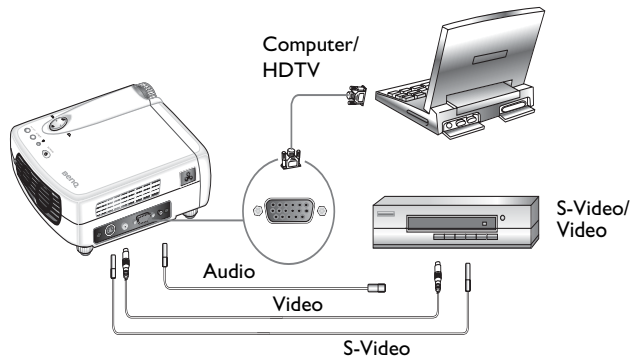

OPERATION

Start Up

1. Plug the power cord into a wall socket.

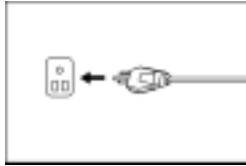

2. Press and hold POWER for 1 second.

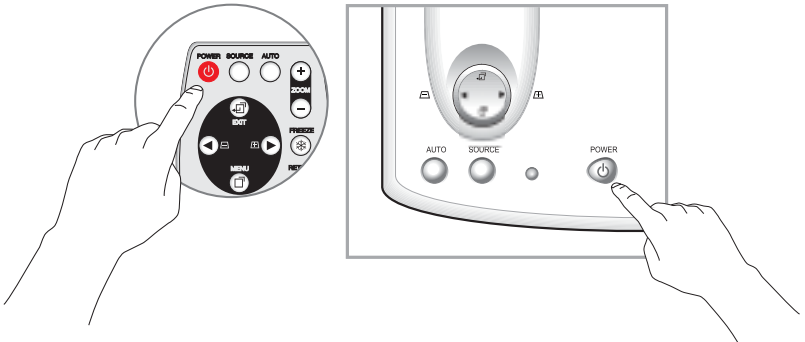

- The back-lit POWER key blinks green and stays green when the power is turned on. (When the power is turned off, there is a 60-second cooling period before the projector can be re-started.)
3. Switch on all connected equipment.

Digital Keystone Correction

Keystoning is when the projected image is noticeably wider at either the top or bottom. To correct this, press **KEYSTONE +/-** (hot key) on the control panel of the projector or on the remote control, then adjust the sliding bar labeled **Keystone**, as needed. Press **+** to correct keystoning at the top of the image. Press **-** to correct keystoning at the bottom of the image.

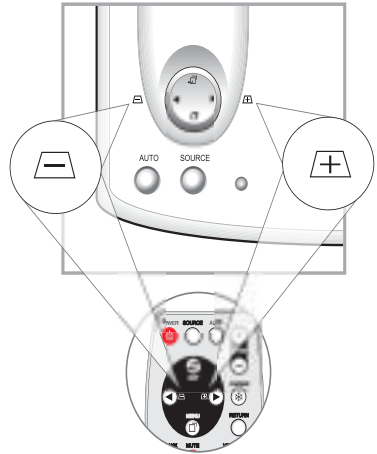

Auto Adjustment

In some cases, you may have to optimize the picture quality manually. To do this, press the **AUTO** key on the control panel of the projector or on the remote control. Within 3 seconds, the built-in Intelligent Auto Adjustment function will re-adjust to the best picture quality.

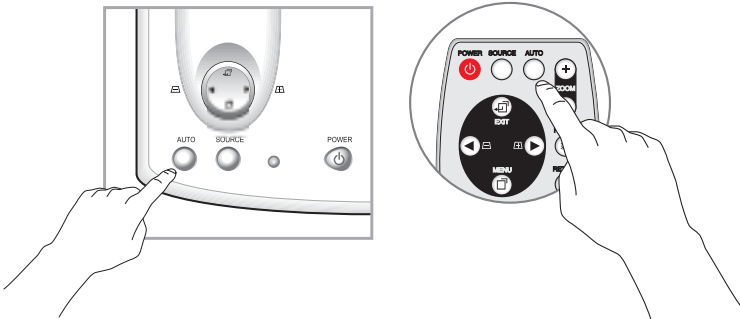



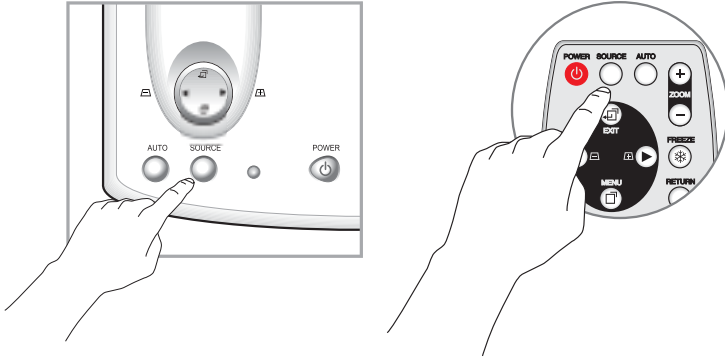

Source Selection

When several input sources are available, press the SOURCE key to make a selection from the control panel of the projector or the remote control.



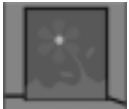



Menu System

Press **Menu** for the main menu and press ◀ or ▶ to select a sub-menu. Press **Menu** again to select items in the sub-menu.

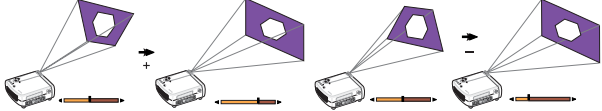
Menu Bar					
Sub-menu	Display	Image	Source	Control	PIP
PC	Keystone Brightness Contrast Phase H. Size	Ratio H-position V-position Color Temp Information	Mirror Source Scan Volume Treble Bass Mute	Language OSD OSD Time Auto Off Reset Lamp Hour	Main page: PIP Source PIP Size PIP Pos. H. Position V. Position More Options Sub Page: Brightness Contrast Color Tint Sharpness
Y/Pb/Pr		Ratio Color Tint Color Temp			
Video	Keystone Brightness Contrast Color	Ratio System Sharpness Color Temp Information			
S-Video	Tint				





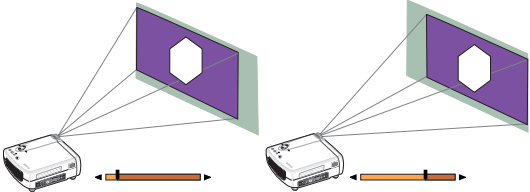
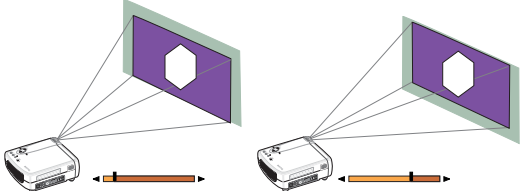

I. Display Menu

FUNCTION	DESCRIPTION
Keystone	Corrects the keystone of the image. 
Brightness	Adjusts the brightness of the image. 
Contrast	Adjusts the degree of difference between darkness and lightness of the image. 
Phase	Adjusts to fit in the desired image size.  <i>*This function is available only when the input mode is PC or YPbPr.</i>
H. Size	Adjusts to avoid the occurrence of flicker. <i>*This function is available only when the input mode is PC or YPbPr.</i>
Color	Adjusts to increase or decrease the colors (R, G, B) of image. <i>*This function is not available when the input mode is PC.</i>
Tint	Adjusts to make the image look more red or blue. <i>*This function is not available when the input mode is PC.</i>

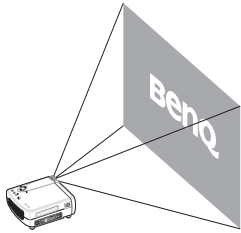
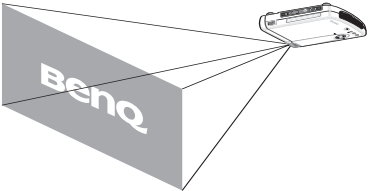
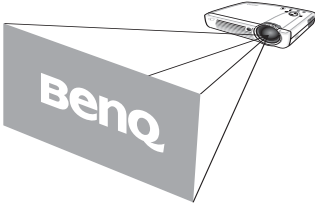
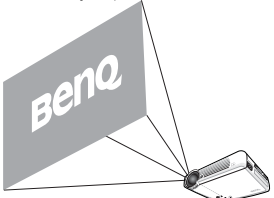
2. Image Menu

FUNCTION	DESCRIPTION
Ratio	Users have 3 options for the image ratio. 1. 4:3 2. 16:9 3. 1:1 <i>*1:1 is available only when the input mode is PC.</i>
H-position	Adjusts the horizontal position of the image.  <i>*This function is available only when the input mode is PC.</i>
V-position	Adjusts the vertical position of the image.  <i>*This function is available only when the input mode is PC.</i>
Color Temp.	Adjusts the color temperature to fit your preference.
Information	Shows the current resolution.
System	System information will be shown as: 1. NTSC 2. PAL 3. SECAM 4. YUV <i>*The default setting of System is NTSC.</i> <i>*This function is available only when the input mode is Video or S-Video.</i>
Sharpness	Adjusts to make the image look sharper or softer. <i>*This function is available only when the input mode is Video or S-Video.</i>
Color	Adjusts to increase or decrease the colors (R, G, B) of the image. <i>*This function is not available when the input mode is PC.</i>
Tint	Adjusts to make the image look more red or blue. <i>*This function is not available when the input mode is PC.</i>

3. Source Menu

FUNCTION	DESCRIPTION
<p>Mirror</p>	<p>1. Default</p>  <p>2. Ceiling-mounted projection</p>  <p>3. Rear screen projection</p>  <p>4. Ceiling-mounted and rear screen projection.</p> 
<p>Source Scan</p>	<p>If Source Scan is on, all the input sources will be detected during the start-up process. Otherwise, the projector will only detect the last input source.</p>
<p>Volume</p>	<p>Adjusts the volume level.</p> 
<p>Treble</p>	<p>Adjusts the treble level.</p> 
<p>Bass</p>	<p>Adjusts the bass level.</p> 
<p>Mute</p>	<p>Off  On </p>

4. Control Menu

FUNCTION	DESCRIPTION
Language	Language sets the OSD to display in one of 8 languages. Use ◀ / ▶ key to select the languages: English, French, German, Italian, Spanish, Korean, Simplified Chinese and Traditional Chinese.
OSD	Selects a desired OSD position.
OSD Time	Sets the length of time the OSD will remain active after the last time you pressed the button. The range is from 5 to 60 seconds in 5-second increments.
Auto Off	Sets the length of time to shut off the system when no input is detected.
Reset	Returns all settings to the time of manufacturing.
Lamp Hour	Shows lamp usage time.

5. PIP Menu

These functions are valid only when the input mode is PC and the PIP source is Video or S-Video.

FUNCTION	DESCRIPTION
PIP Source	Selects the source from which the PIP picture comes.
PIP Size	Uses ◀ / ▶ key to scroll through the 4 alternatives: Off, Small, Medium, Large.
PIP Position	Selects a desired PIP position.
H. Position	Adjusts the horizontal position of PIP image.
V. Position	Adjusts the vertical position of PIP image.
More Options	Uses ◀ / ▶ key to select more PIP functions including Brightness, Contrast, Color, Tint, Sharpness and System.
Brightness	Adjusts the brightness of PIP image.
Contrast	Adjusts the degree of difference between darkness and lightness of PIP image.
Color	Adjusts to increase or decrease the colors (R, G, B) of the image.
Tint	Adjusts to make the image look more red or blue.
Sharpness	Adjusts to make the image look sharper or softer

Shutdown

1. Press and hold **POWER** and a warning message will prompt up. To turn off the projector, Press **POWER** again.

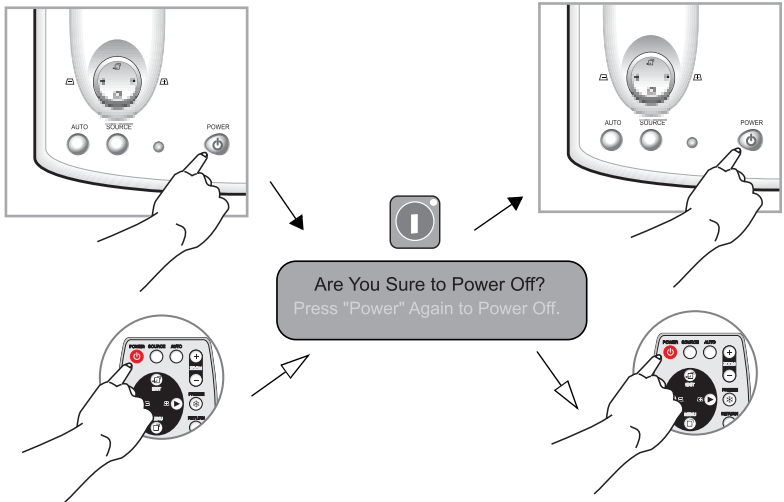

2. The fan will continue to run for approximately 60 seconds.
3. Disconnect the power cord from the wall socket.

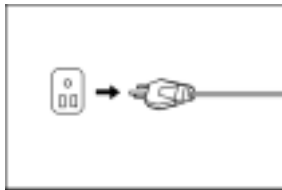

Caution

Please do not unplug the power cord before **POWER** is shut down or during the 60-second cooling process.

MAINTENANCE

Lamp Information

Use and Replacement of Lamp

When the Lamp Indicator lights up red or a message appears to suggest the time of lamp replacement, please install a new lamp or consult your dealer. An old lamp could cause a malfunction in the projector and may explode.

LED Status Indicators

Lamp Life Indicators	When this LED shows red continuously, it is warning you that the lamp life has exceeded 2000 hours. Replace the projection lamp with a new one immediately.
CHANGE THE LAMP, AND RESET THE LAMP TIMER	The lamp has been in operation for 1900 hours. Change a new lamp for optimal performance.
CHANGE THE LAMP. THE POWER WILL TURN OFF AFTER 20 HOURS	The lamp has been in operation for 1980 hours, and the power will turn off after 20 hours.
CHANGE THE LAMP!	The lamp has been in operation for over 2000 hours. The warning message will display for 30 seconds every 5 minutes after you turn on the projector and the power will turn off automatically in 10 minutes.
Lamp is not properly attached	LED blinks rapidly.
Temperature is too high	When the projector's internal temperature is too high to operate safely, the LED blinks slowly for one minute and the lamp turns off automatically. If the LED light is off, the projector's lamp and temperature are operating under normal conditions.

Caution

The LAMP indicator will light up if the lamp becomes too hot. Turn off the power and let the projector cool for 45 minutes. If the LAMP indicator is still red when turning the power on, please contact your dealer.

Lamp Replacement

Caution

To reduce the risk of electrical shock, always turn off the projector and disconnect the power cord from the outlet and the projector.

1. Press the **POWER** button to switch off the projector. Disconnect the power cord from the outlet and the projector.
2. Loosen the screw and remove the lamp cover. If the lamp is hot, avoid burns by waiting 45 minutes until the lamp has cooled.
3. Loosen the 3 screws. (It is strongly recommended you use a magnetic-headed screwdriver.) Pull the handle to remove the lamp housing. If the screws are not loosened completely, they could injure your fingers. Do not insert your hand into the box after the lamp is removed. If you touch the optical parts inside, this could cause color unevenness.
4. Replace the lamp with a new one. Insert it into the projector, and tighten the screws firmly. Loose screws may cause a bad connection, which may result in malfunction.
5. Re-install the lamp cover and tighten the screw. **Do not turn on the power with the lamp cover removed.** Whenever the lamp is replaced, reset the total lamp operation time. **Do not reset if the lamp is not replaced as this could cause breakage.**

2.

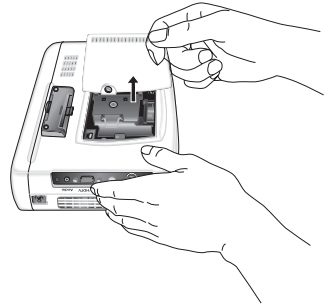

3.

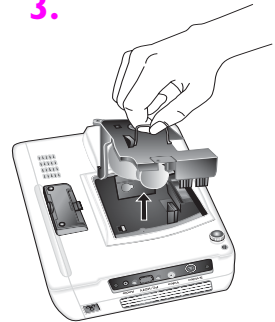

4.



⚠ Caution

To reduce the risk of severe burns, allow the projector to cool for at least 45 minutes before replacing the lamp.



To reduce the risk of injuries to fingers and damage to internal components, use caution when removing lamp glass that has shattered into sharp pieces.

To reduce the risk of injuries to fingers and/or decreasing image quality by touching the lens, do not touch the empty lamp compartment when the lamp is removed.

This lamp contains mercury. Consult your local hazardous waste regulations to dispose of this lamp in a proper manner.

Resetting Lamp Hours

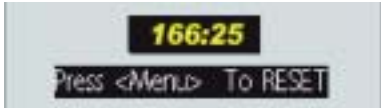
If you replace the lamp after 2000 hours of operation, please follow the instructions below within 10 minutes of power on.

OSD	FUNCTION
	<p>Press the Exit button on the projector for 3 seconds to display the total used lamp time.</p>
	<ul style="list-style-type: none"> • Press the MENU button on the projector during the lamp hour message. An adjustment message will appear. • Press ◀ or ▶ to rest lamp hours or press EXIT to leave.

Service Information

Accessories (Included in the standard package)

Description	Part Number
Power cord (EU)	27.01218.191
Power cord (US)	27.01118.131
Power cord (UK)	27.02718.201
VGA cable	50.J0508.502
Video cable	50.J1303.501
S-Video cable	50.72920.011
PC - PC audio cable	50.74405.501
RCA R/W - audio cable	50.J1311.001
Soft carrying case	98.J2202.001
Remote control	98.J2406.001
3-2 converter	22.91007.001

Optional Accessories (Not included in the standard package)

Description of parts	Part Number
Mac adapter (switchable)	20.20118.A15
Spare lamp kit	60.J2203.CB1
HDTV cable	50.J2401.001
Ceiling mount kit	60.J2439.011
Presentation wizard kit	60.J2478.001

Ordering Parts or Getting Information

For product information, product assistance, service information, or to order accessories, please contact BENQ Corporation at <http://www.BenQ.com>.

TROUBLESHOOTING

Common Problems & Solutions

PROBLEMS	TRY THESE SOLUTIONS
NO POWER	<ul style="list-style-type: none"> • Plug the power cord into the AC inlet. • Plug the power cord into the power inlet. • Wait two minutes after the projector is turned off before turning the projector back on.
NO PICTURE	<ul style="list-style-type: none"> • Check for the proper input source. • Ensure all cables are connected properly. • Adjust the brightness and contrast. • Remove the lens cap.
TRAPEZOID IMAGE ON THE SCREEN	<ul style="list-style-type: none"> • Reposition the unit to improve its angle on the screen. • Use the Keystone correction key on the control panel of the projector or the remote control unit.
POOR COLOR	<ul style="list-style-type: none"> • Select the correct video system. • Adjust brightness, contrast, or saturation.
BLURRED IMAGE	<ul style="list-style-type: none"> • Press Auto on the control panel of the projector or the remote control unit to get better picture quality. • Adjust the focus. • Reposition the unit to improve its projection angle. • Ensure the distance between the unit and screen is within the adjustment range of the lens.
REMOTE CONTROL DOES NOT WORK	<ul style="list-style-type: none"> • Replace the batteries with new ones. • Make sure there is no obstacle between the remote control and the unit. • Stand within 6 meters (19.5 feet) of the projector. • Make sure nothing blocking the front and rear receivers.

Status Messages

On Screen Messages	Description
SEARCHING	Projector is searching for input.
INPUT SIGNAL DETECTED, ACTIVATING AUTO IMAGE	Projector has identified the input signal and is running the auto image adjustment function.
SYNC IS OUT OF RANGE	Input signal frequency exceeds the projector's range.
CHANGE THE LAMP, AND RESET THE LAMP TIMER	The lamp has been in operation for 1900 hours. Lamp replacement is recommended.
CHANGE THE LAMP, THE POWER WILL TURN OFF AFTER 20 HOURS	The lamp has been in operation for 1980 hours, and the power will turn off after 20 more hours. Replace the lamp as soon as possible.
CHANGE THE LAMP!	The lamp has been in operation for over 2000 hours, and the power will turn off automatically in 10 minutes. Replace the lamp immediately.

SPECIFICATIONS

Projector Specifications

TECHNICAL SPECIFICATIONS

Note: All specifications are subject to change without notice.

General

Product name	Personal Projector		
Model name	PB2220	1024X768	XGA
	PB2120	800X600	SVGA

Optical

Display system	I-CHIP DMD
Lens F/Number	F/2.4 ~ 2.6
Lamp	150W VIP lamp

Electrical

Power supply	AC100 ~ 240V, 2.3A, 50/60 Hz (Automatic)
Power consumption	220 W (Max)

Mechanical

Dimensions	220 mm (W) x 52 mm (H) x 175 mm (D)
Operating Temperature range	10°C ~ 40°C
Weight	3.92 lbs (1.78 Kg)

Input terminal

Computer Input	
RGB/ HDTV Input	D-sub 15-pin (female)
Video Signal Input	
S VIDEO	Mini DIN 4-pin terminal
VIDEO	RCA Jack terminal
Audio Signal Input	
Audio	Mini Jack Stereo Terminal

Output

Speaker	0.5 Watt x 1
---------	--------------

Timing Chart

RESOLUTION	H SYNC (KHZ)	V SYNC (HZ)	REMARK
640x350	31.5	70.1	
640x400	37.9	85.1	VESA
720x400	31.5	70.0	
720x400	37.9	85.1	VESA
640x480	31.5	60.0	VESA
640x480	37.9	72.8	VESA
640x480	35.0	66.7	Macintosh
640x480	43.3	85.0	VESA
800x600	35.2	56.3	VESA
800x600	37.9	60.3	VESA
800x600	46.9	75.0	VESA
800x600	48.1	72.2	VESA
800x600	53.7	85.1	VESA
832x624	49.7	74.5	Macintosh
1024x768	48.4	60.0	VESA
1024x768	56.5	70.1	VESA
1024x768	60.0	75.0	VESA
1024x768	68.7	85.0	VESA
1280x1024	64.0	60.0	VESA

DIMENSIONS

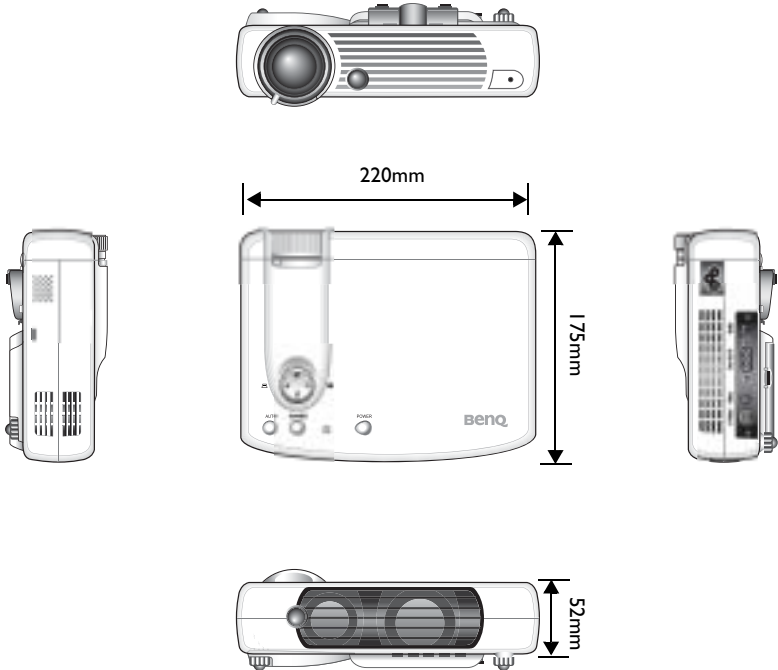

WARRANTY

Limited Warranty

BENQ warrants this product against any defects in material and workmanship, under normal usage and storage.

Exclusion to Warranty: The lamps are considered a consumable item and are warranted for 90 days or 500 hours, whichever occurs first. Proof of purchase date will be required with any warranty claim. In the event this product is found to be defective within the warranty period, BENQ's only obligation and your exclusive remedy shall be replacement of any defective parts (labor included). To obtain warranty service, immediately notify the dealer from which you purchased the product of any defects.

Important: The above warranty shall be void if the customer fails to operate the product in accordance with BENQ's written instructions. This warranty gives you specific legal rights, and you may have other rights which vary from country to country.

For more detailed information, please refer to BenQ Warranty Information Book.

SAFETY REGULATIONS

FCC Statement

CLASS A: This equipment generates, uses and can radiate radio frequency energy, and if not installed and used in accordance with the instruction manual, may cause interference to radio communications. It has been tested and found to comply with the limits for a Class "A" computing device pursuant to Subpart B of Part 15 of the FCC Rules, which are designed to provide reasonable protection against such interference when operated in a commercial environment. Operation of this equipment in a residential area is likely to cause interference, in which case the user at his/her own expense will be required to take whatever measures may be required to correct the interference.

CLASS B: This equipment generates, uses and can radiate radio frequency energy and, if not installed and used in accordance with the instructions, may cause harmful interference to radio communications. However, there is no guarantee that interference will not occur in a particular installation. If this equipment does cause harmful interference to radio or television reception, which can be determined by turning the equipment off and on, the user is encouraged to try to correct the interference by one or more of the following measures:

- Reorient or relocate the receiving antenna.
- Increase the distance between the equipment and receiver.
- Connect the equipment into an outlet on a circuit different from that to which the receiver is connected.
- Consult the dealer or an experienced radio/TV technician for help.

EEC Statement

This machine was tested against the 89/336/EEC (European Economic Community) for EMC (Electro Magnetic Compatibility) and fulfills these requirements.