

BenQ

MP510 Digital Projector

Mainstream Series

User Manual

Welcome

Table of contents

Important safety instructions	4
Introduction	8
Projector features	8
Shipping contents	8
Projector exterior view.....	9
Controls and functions	10
Positioning your projector	13
Choosing a location	13
Obtaining a preferred projected picture size	14
Connection	17
Connecting a computer	17
Connecting Video source devices	18
Operation	21
Start up	21
Utilizing the password function	22
Switching input signal.....	24
Adjusting the projected picture	24
Optimizing the picture	27
Setting the presentation timer	29
Hiding the picture	30
Freezing the picture	31
Operating in a high altitude environment	31
Shutting down the projector	32
Menu operation	33
Maintenance	40
Care of the projector	40
Lamp information.....	41
Troubleshooting	47
Specifications	48
Projector specifications	48

Timing chart	49
Warranty and Copyright information	50
Limited warranty	50
Copyright	50
Disclaimer	50
Regulation statements	51
FCC statement	51
EEC statement	51
MIC statement	51
WEEE directive	51

1. Important safety instructions

Your BenQ projector is designed and tested to meet the latest standards for safety of information technology equipment. However, to ensure safe use of this product, it is important that you follow the instructions mentioned in this manual and marked on the product.

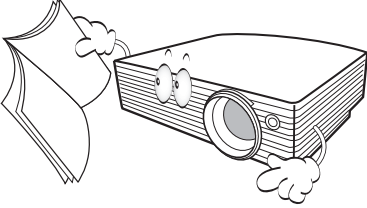
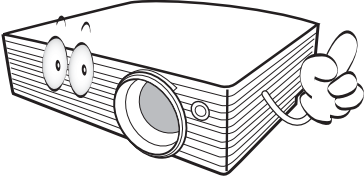
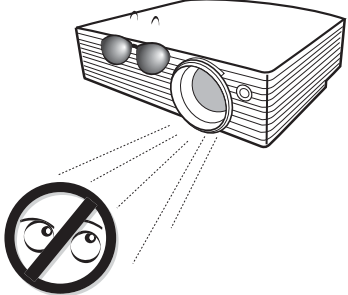
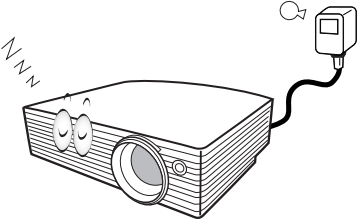
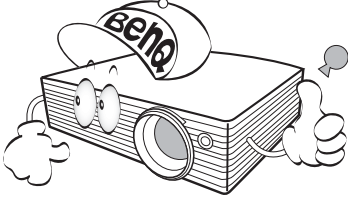
Safety Instructions	
<p>1. Please read this manual before you operate your projector. Save it for future reference.</p> 	<p>4. Always open the lens shutter or remove the lens cap when the projector lamp is on.</p> 
<p>2. Do not look straight at the projector lens during operation. The intense light beam may damage your eyes.</p> 	<p>5. In some countries, the line voltage is NOT stable. This projector is designed to operate safely within a mains voltage between 100 to 240 volts AC, but could fail if power cuts or surges of ± 10 volts occur. In areas where the mains voltage may fluctuate or cut out, it is recommended that you connect your projector through a power stabilizer, surge protector or uninterruptible power supply (UPS).</p> 
<p>3. Refer servicing to qualified service personnel.</p> 	<p>6. Do not block the projection lens with any objects when the projector is under operation as this could cause the objects to become heated and deformed or even cause a fire. To temporarily turn off the lamp, press BLANK on the projector or remote control.</p>

Safety Instructions (Continued)

7. The lamp becomes extremely hot during operation. Allow the projector to cool for approximately 45 minutes prior to removing the lamp assembly for replacement.

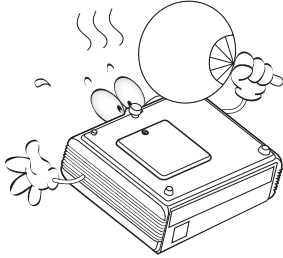

8. Do not operate lamps beyond the rated lamp life. Excessive operation of lamps beyond the rated life could cause them to break on rare occasions.

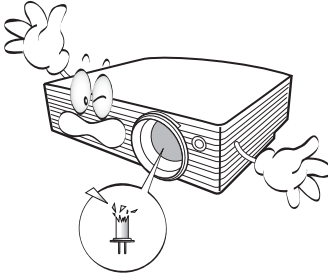

9. Never replace the lamp assembly or any electronic components unless the projector is unplugged.

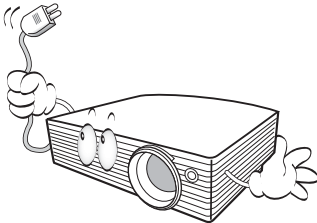

10. Do not place this product on an unstable cart, stand, or table. The product may fall, sustaining serious damage.

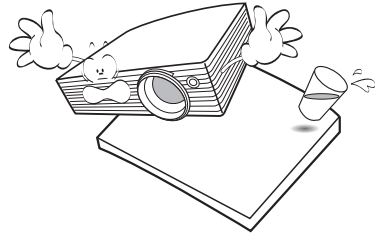

11. Do not attempt to disassemble this projector. There are dangerous high voltages inside which may cause death if you should come into contact with live parts. The only user serviceable part is the lamp which has its own removable cover. Under no circumstances should you ever undo or remove any other covers. Refer servicing only to suitably qualified professional service personnel.

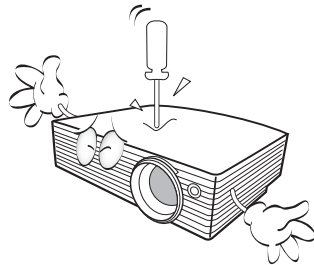

Safety Instructions (Continued)

12. Do not place this projector in any of the following environments.

- Space that is poorly ventilated or confined. Allow at least 50 cm clearance from walls and free flow of air around the projector.
- Locations where temperatures may become excessively high, such as the inside of a car with all windows rolled up.
- Locations where excessive humidity, dust, or cigarette smoke may contaminate optical components, shortening the projector's life span and darkening the picture.

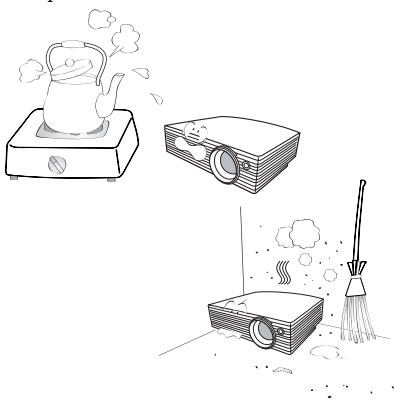

- Locations near fire alarms
- Locations with an ambient temperature above 40°C / 104°F
- Locations where the altitudes are higher than 3000 m (10000 feet).

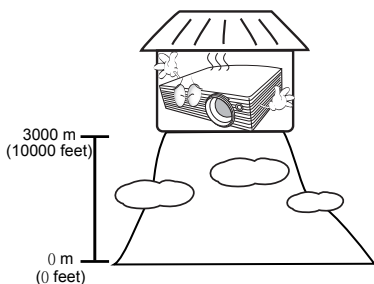

13. Do not block the ventilation holes.
- Do not place this projector on a blanket, bedding or any other soft surface.
 - Do not cover this projector with a cloth or any other item.
 - Do not place inflammables near the projector.

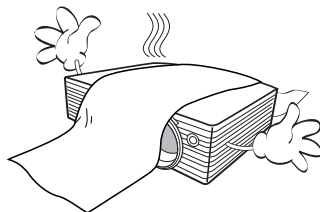

If the ventilation holes are seriously obstructed, overheating inside the projector may result in a fire.

14. Always place the projector on a level, horizontal surface during operation.
- Do not use if tilted at an angle of more than 10 degrees left to right, nor at angle of more than 15 degrees front to back. Using the projector when it is not fully horizontal may cause a malfunction of, or damage to, the lamp.

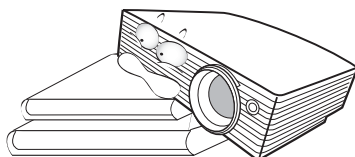

15. Do not stand the projector on end vertically. Doing so may cause the projector to fall over, causing injury or resulting in damage to the projector.

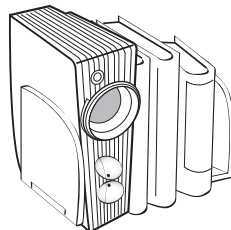

Safety Instructions (Continued)

16. Do not step on the projector or place any objects upon it. Besides probable physical damage to the projector, doing so may result in accidents and possible injury.



17. Do not place liquids near or on the projector. Liquids spilled into the projector may cause it to fail. If the projector does become wet, disconnect it from the power supply's wall socket and call BenQ to have the projector serviced.

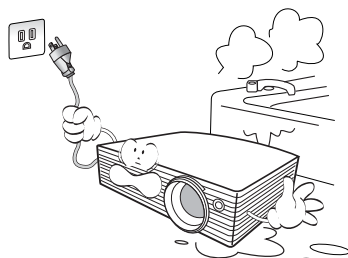

18. This product is capable of displaying inverted pictures for ceiling mount installation.



Use only BenQ's Ceiling Mount Kit for mounting the projector and ensure it is securely installed.

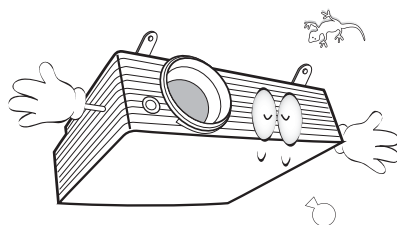

19. When the projector is under operation, you may sense some heated air and odor from its ventilation grill. It is a normal phenomenon and not a product defect.

Safety instructions for ceiling mounting of the projector

We want you to have a pleasant experience using your BenQ projector, so we need to bring this safety matter to your attention to prevent damage to person and property.

If you intend to mount your projector on the ceiling, we strongly recommend that you use a proper fitting BenQ projector ceiling mount kit and that you ensure it is securely and safely installed.

If you use a non-BenQ brand projector ceiling mount kit, there is a safety risk that the projector may fall from the ceiling due to an improper attachment through the use of the wrong gauge or length screws.

You can purchase a BenQ projector ceiling mount kit from the place you purchased your BenQ projector. BenQ recommends that you also purchase a separate Kensington lock compatible security cable and attach it securely to both the Kensington lock slot on the projector and the base of the ceiling mount bracket. This will perform the secondary role of restraining the projector should its attachment to the mounting bracket become loose.

2. Introduction

Projector features

The projector integrates high-performance optical engine projection and a user-friendly design to deliver high reliability and ease of use.

The projector offers the following features.

- Wall color correction allowing projection on surfaces of several predefined colors
- Selectable password protected function
- Compact and portable unit
- One-key auto-adjustment to display the best picture quality
- Digital keystone correction to correct distorted pictures
- Adjustable color balance control for data/video display
- Ability to display 16.7 million colors
- Multi-language On-Screen Display (OSD) menus
- Switchable normal and Economic modes to reduce the power consumption
- Component HDTV compatibility (YPbPr)
- Up to 7 sets of picture modes providing multiple choices for different projection purposes



- **The apparent brightness of the projected picture will vary depending on the ambient lighting conditions, selected input source contrast/brightness settings, and is directly proportional to projection distance.**
- **The lamp brightness will decline over time and may vary within the lamp manufacturers specifications. This is normal and expected behavior.**

Shipping contents

The projector is shipped with the cables required for connection to a PC. Carefully unpack and verify that you have all of the items shown below. If any of these items are missing, please contact your place of purchase.

Standard packing list

- | | |
|---|----------------------------------|
| 1. Projector | 5. Multi-language user manual CD |
| 2. Card type remote control and battery | 6. VGA cable |
| 3. User manual | 7. Power cord |
| 4. Quick start guide | |

Optional accessories

- | | |
|-------------------------|----------------------|
| 1. Spare lamp kit | 3. Presentation Plus |
| 2. Ceiling mounting kit | 4. Soft carry case |

Projector exterior view

Front/upper side

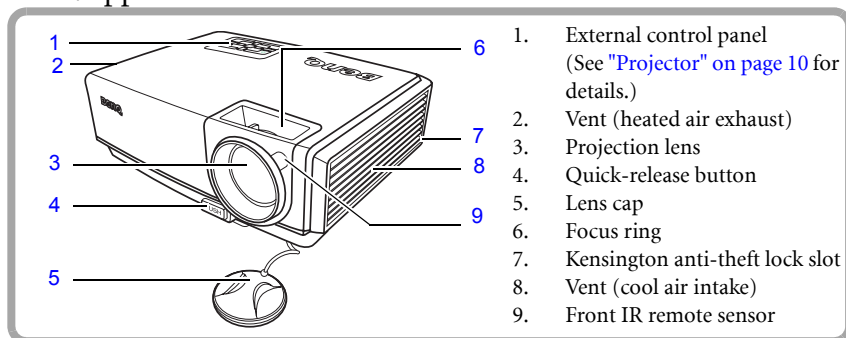

Rear side

See "Connection" on page 17 for details.

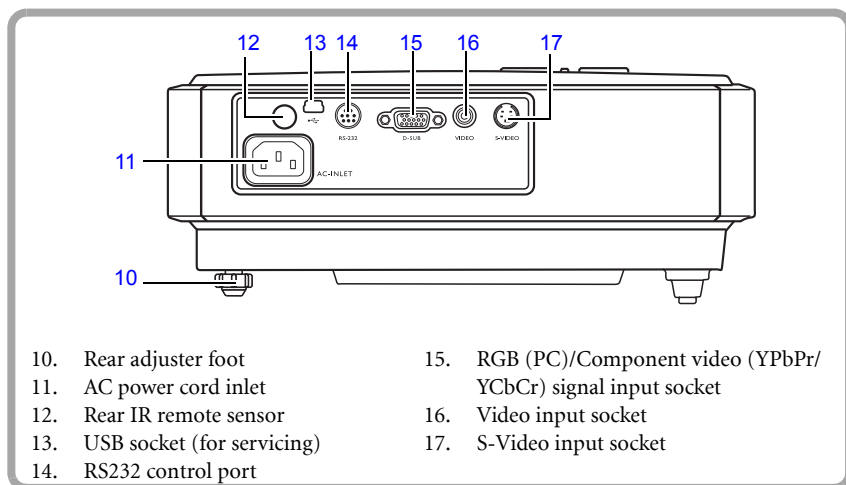

Under side

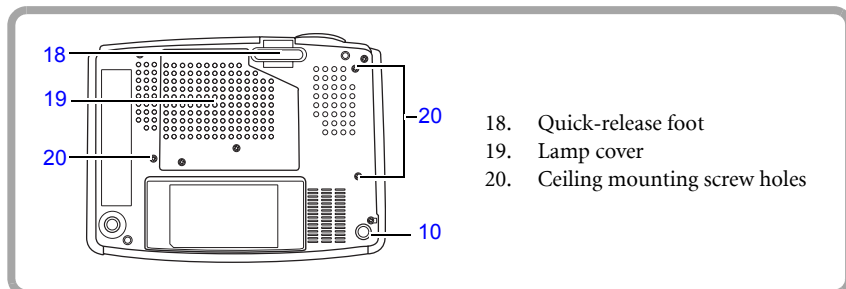

Controls and functions

Projector

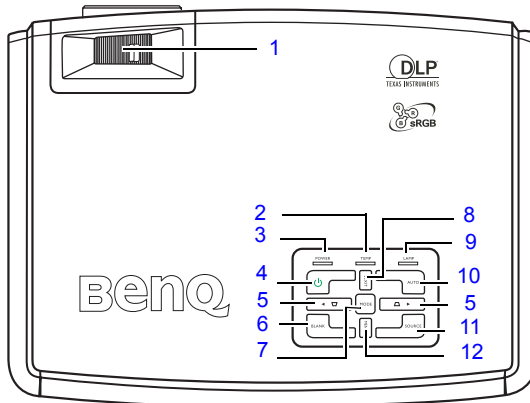

- 1. Focus ring** (See ["Fine-tuning the picture clarity" on page 26](#) for details.)
Adjusts the focus of the projected picture.
- 2. Temperature warning light** (See ["Indicators" on page 45](#) for details.)
Lights red if the projector's temperature becomes too high.
- 3. Power indicator light** (See ["Indicators" on page 45](#) for details.)
Lights up or flashes when the projector is under operation.
- 4. Power** (See ["Start up" on page 21](#) and ["Shutting down the projector" on page 32](#) for details.)
Turns the projector on or off.
- 5. Keystone/Arrow buttons** (▽ / ◀Left, ▷ / ▶ Right)
Manually corrects distorted pictures resulting from an angled projection. Selects the desired menus and to make adjustments.
See ["Correcting keystone" on page 25](#) and ["Using the OSD menus" on page 34](#) for details.
- 6. BLANK** (See ["Hiding the picture" on page 30](#) for details.)
Used to hide the screen picture.
- 7. MODE** (See ["Selecting a picture mode" on page 27](#) for details.)
Sequentially selects a predefined picture setting available for each input.
- 8. ▲ EXIT** (See ["Using the OSD menus" on page 34](#) for details.)
Exits and saves the menu settings.
- 9. Lamp indicator light** (See ["Indicators" on page 45](#) for details.)
Indicates the status of the lamp. Lights up or flashes when the lamp has developed a problem.
- 10. AUTO** (See ["Auto-adjusting the picture" on page 25](#) for details.)
Automatically determines the best picture timings for the displayed picture.
- 11. SOURCE** (See ["Switching input signal" on page 24](#) for details.)
Sequentially selects the input signal D-Sub/Sub/Comp. (Component Video), S-Video or Video.
- 12. ▼ MENU** (See ["Using the OSD menus" on page 34](#) for details.)
Turns on the On-Screen Display (OSD) menu.
Selects the desired menu items.

Remote control

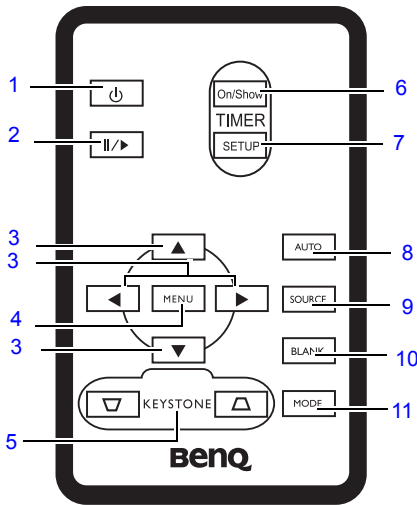

1. **Power** (See ["Start up"](#) on page 21 and ["Shutting down the projector"](#) on page 32 for details.)
Turns the projector on or off.
2. **Freeze** (See ["Freezing the picture"](#) on page 31 for details.)
Freezes the projected picture.
3. **▲ Up, ▼ Down, ◀ Left, ▶ Right** (See ["Using the OSD menus"](#) on page 34 for details.)
When the On-Screen Display (OSD) menu is activated, the buttons are used as directional arrows to select the desired menu items and to make adjustments.
4. **MENU** (See ["Using the OSD menus"](#) on page 34 for details.)
Displays or hides the On-Screen Display (OSD) menu system.
5. **Keystone** (See page ["Correcting keystone"](#) on page 25 for details.)
Manually corrects distorted pictures resulting from an angled projection.
6. **TIMER On/Show** (See ["Setting the presentation timer"](#) on page 29 for details.)
Activates or displays an on-screen timer based on your own timer setting.
7. **TIMER SETUP** (See ["Setting the presentation timer"](#) on page 29 for details.)
Enters presentation timer setting directly.
8. **AUTO** (See ["Auto-adjusting the picture"](#) on page 25 for details.)
Automatically determines the best picture timings for the displayed picture.
9. **SOURCE** (See ["Switching input signal"](#) on page 24 for details.)
Sequentially selects the input signal D-Sub/Comp. (Component Video), S-Video or Video.
10. **BLANK** (See ["Hiding the picture"](#) on page 30 for details.)
Used to hide the screen picture. Press any key on the remote control to restore the picture.
11. **MODE** (See ["Selecting a picture mode"](#) on page 27 for details.)
Sequentially selects a predefined picture setting available for each input.

Remote control effective range

Infra-Red (IR) remote control sensors are located on the front and the back of the projector. The remote control must be held at an angle within 30 degrees perpendicular to the projector's IR remote control sensors to function correctly. The distance between the remote control and the sensors should not exceed 6 meters (~ 20 feet).

Make sure that there are no obstacles between the remote control and the IR sensors on the projector that might obstruct the infra-red beam.

- **Operating the projector from the front**

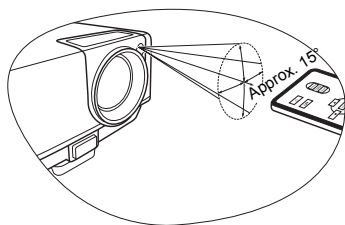

- **Operating the projector from the rear**

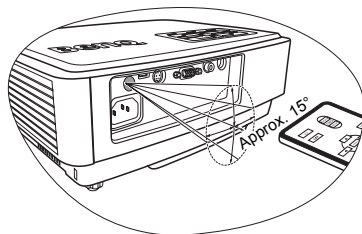

Replacing the remote control battery

1. Pull out the battery holder.

 **Please follow the illustrated instructions. Push and hold the locking arm while pulling out the battery holder.**

2. Insert the new battery in the holder. Note the positive polarity should face outward.
3. Push the holder into the remote control.



- **Avoid excessive heat and humidity.**

- **There may be battery damage if the battery is incorrectly replaced.**
- **Replace only with the same or equivalent type recommended by the battery manufacturer.**
- **Dispose of the used battery according to the battery manufacturer's instructions.**
- **Never throw a battery into a fire. There may be danger of an explosion.**
- **If the battery is dead or if you will not be using the remote control for a long time, remove the battery to prevent damage to the remote control from possible battery leakage.**

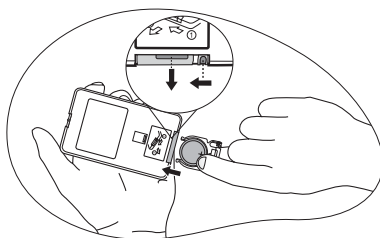









3. Positioning your projector

Choosing a location

Your projector is designed to be installed in one of four possible installation locations:

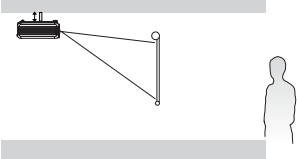
1. Table in front of screen;
2. Ceiling in front of screen;
3. Table at rear of screen;
4. Ceiling at rear of screen.

<p>1. Front Table Select this location with the projector placed near the floor in front of the screen. This is the most common way to position the projector for quick setup and portability.</p> <p>2. Front Ceiling Select this location with the projector suspended upside-down from the ceiling in front of the screen. Purchase the BenQ Projector Ceiling Mounting Kit from your dealer to mount your projector on the ceiling.</p> <p>Set  in the  Advanced > Mirror menu after you turn the projector on.</p> <p>3. Rear Table Select this location with the projector placed near the floor behind the screen. Note that a special rear projection screen is required.</p> <p>Set  in the  Advanced > Mirror menu after you turn the projector on.</p> <p>4. Rear Ceiling Select this location with the projector suspended upside-down from the ceiling behind the screen. Note that a special rear projection screen and the BenQ Projector Ceiling Mounting Kit are required for this installation location.</p> <p>Set  in the  Advanced > Mirror menu after you turn the projector on.</p>	   
--	--

Your room layout or personal preference will dictate which installation location you select. Take into consideration the size and position of your screen, the location of a suitable power outlet, as well as the location and distance between the projector and the rest of your equipment.

Obtaining a preferred projected picture size

The distance from the projector lens to the screen, and the video format each factors in the projected picture size.

The native resolution of the projector is 800 x 600 pixels, which is a 4 to 3 aspect ratio (expressed as 4:3). To be able to project a complete 16:9 (widescreen) aspect ratio picture, the projector can resize and scale a widescreen picture to the projector's native aspect width. This will result in a proportionally smaller height equivalent to 75% of the projector's native aspect height.

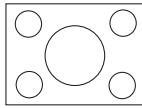

4:3 aspect picture in a 4:3 aspect display area

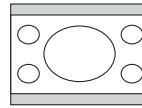

16:9 aspect picture scaled to a 4:3 aspect display area

Thus, a 16:9 aspect picture will not utilize 25% of the height of a 4:3 aspect picture displayed by this projector. This will be seen as darkened (unlit) bars along the top and bottom (vertical 12.5% height respectively) of the 4:3 projection display area whenever displaying a scaled 16:9 aspect picture in the vertical center of the 4:3 projection display area.

When determining the position of your projector, you should consider its intended use and input signal aspect ratios. All inputs (other than composite Video being fed a 16:9 aspect signal) will display in a 4:3 aspect ratio (and will require an additional 33% display height than that of the scaled 16:9 aspect picture projection area).

Do not select a permanent projector position based upon a 16:9 projection if you will ever need to select an input (other than composite Video being fed a 16:9 aspect signal).

The projector should always be placed horizontally level (like flat on a table), and positioned directly perpendicular (90° right-angle square) to the horizontal center of the screen. This prevents picture distortion caused by angled projections (or projecting onto angled surfaces).

The modern digital projector does not project directly forward (like older style reel-to-reel film projectors did). Instead, digital projectors are designed to project at a slightly upward angle above the horizontal plane of the projector. This is so that they can be readily placed on a table and will project forward and upwards onto a screen positioned so that the bottom edge of the screen is above the level of the table (and everyone in the room can see the screen).

If the projector is mounted on a ceiling, it must be mounted upside-down so that it projects at a slightly downward angle.

You can see from the diagram on page 16, that this type of projection causes the bottom edge of the projected picture to be vertically offset from the horizontal plane of the projector. When ceiling mounted, this refers to the top edge of the projected picture.

If the projector is positioned further away from the screen, the projected picture size increases, and the vertical offset also increases proportionately.

When determining the position of the screen and projector, you will need to account for both the projected picture size and the vertical offset dimension, which are directly proportional to the projection distance.

BenQ has provided a table of 4:3-aspect-ratio screen sizes to assist you in determining the ideal location for your projector. There are two dimensions to consider, the perpendicular

horizontal distance from the center of the screen (projection distance), and the vertical offset height of the projector from the horizontal edge of the screen (offset).

How to determine the position of the projector for a given screen size

1. Select your screen size.
2. Refer to the table and find the closest match to your screen size in the left columns labelled "[4:3 Screen Diagonal](#)". Using this value, look across this row to the right to find the corresponding average distance from screen value in the column labelled "[Recommended projection distance from screen in mm](#)". This is the projection distance.
3. On that same row, look across to the right column and make note of the vertical offset value. This will determine the final vertical offset placement of the projector in relation to the edge of the screen.
4. The recommended position for the projector is aligned perpendicular to the horizontal center of the screen, at the distance from the screen determined in step 2 above, and offset by the value determined in step 3 above.

For example, if you are using a 120 inch screen, the recommended projection distance is 4800 mm and with a vertical offset of 183 mm.

If you place the projector in a different position (to that recommended), you will have to tilt it down or up to center the picture on the screen. In these situations, some picture distortion will occur. Use the Keystone function to correct the distortion. See "[Correcting keystone](#)" on [page 25](#) for details.

How to determine the recommended screen size for a given distance

This method can be used for situations where you have purchased this projector and would like to know what screen size will fit in your room.

The maximum screen size is limited by the physical space available in your room.

1. Measure the distance between the projector and where you want to position the screen. This is the projection distance.
2. Refer to the table and find the closest match to your measurement in the column labelled "[Recommended projection distance from screen in mm](#)".
3. Using this value, look across that row to the left to find the corresponding screen diagonal listed in that row. That is the projected picture size of the projector at that projection distance.
4. On that same row, look across to the right column and make note of the vertical Offset value. This will determine the final placement of the screen in relation to the horizontal plane of the projector.

For example, if your measured projection distance was 4.5 m (4500mm), the closest match in the "[Recommended projection distance from screen in mm](#)" column is 4320 mm. Looking across this row shows that a 9' (108") screen is required. If you can only obtain a metric sized screen, the screen size is 2743 mm diagonally.

Projection dimensions

Refer to "[Dimensions](#)" on page 48 for the center of lens dimensions of this projector before calculating the appropriate position.

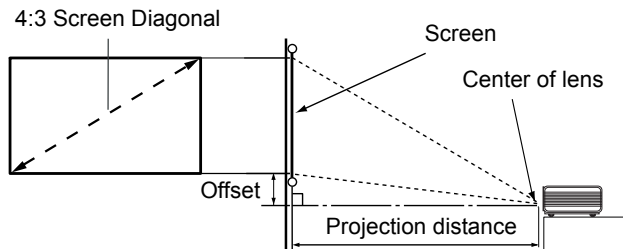

4:3 Screen Diagonal			Recommended projection distance from screen in mm	Vertical Offset in mm
Feet	Inches	mm		
2.5	30	762	1200	46
3	36	914	1440	55
		1000	1575	60
4	48	1219	1920	73
		1500	2362	88
5	60	1524	2400	91
6	72	1829	2880	110
		2000	3149	120
7	84	2134	3360	128
8	96	2438	3840	146
		2500	3937	150
9	108	2743	4320	165
		3000	4724	180
10	120	3048	4800	183
		3500	5512	209
12	144	3658	5760	219
		4000	6299	239
15	180	4572	7200	274
		5000	7874	299
16.7	200	5080	8000	305

 There is 3% tolerance among these numbers due to optical component variations. BenQ recommends that if you intend to permanently install the projector, you should physically test the projection size and distance using the actual projector in situ before you permanently install it, so as to make allowance for this projector's optical characteristics. This will help you determine the exact mounting position so that it best suits your installation location.

4. Connection

When connecting a signal source to the projector, be sure to:

1. Turn all equipment off before making any connections.
2. Use the correct signal cables for each source.
3. Ensure the cables are firmly inserted.

 In the connections shown below, some cables may not be included with the projector (see **"Shipping contents" on page 8**). They are commercially available from electronics stores.

Connecting a computer

The projector provides a VGA input socket that allows you to connect it to a laptop or desktop computer.

To connect the projector to a laptop or desktop computer:

1. Take the supplied VGA cable and connect one end to the D-Sub output socket of the computer.
2. Connect the other end of the VGA cable to the D-SUB signal input socket on the projector.

The final connection path should be like that shown in the following diagram:

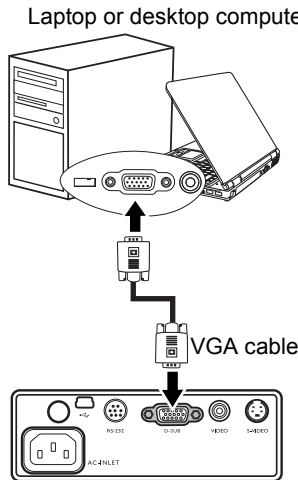

 Many laptops do not turn on their external video ports when connected to a projector. Usually a key combo like FN + F3 or CRT/LCD key turns the external display on/off. Locate a function key labeled CRT/LCD or a function key with a monitor symbol on the laptop. Press FN and the labeled function key simultaneously. Refer to your laptop's documentation to find your laptop's key combination.

Connecting Video source devices

You can connect your projector to various Video source devices that provide any one of the following output sockets:

- Component Video
- S-Video
- Video (composite)

You need only connect the projector to a Video source device using just one of the above connecting methods, however each provides a different level of video quality. The method you choose will most likely depend upon the availability of matching terminals on both the projector and the Video source device as described below:

Best video quality

The best available video connection method is Component Video (not to be confused with composite Video). Digital TV tuner and DVD players output Component Video natively, so if available on your devices, this should be your connection method of choice in preference to (composite) Video.

See "[Connecting a Component Video source device](#)" on page 19 for how to connect the projector to a component video device.

Better video quality

The S-Video method provides a better quality analog video than standard composite Video. If you have both composite Video and S-Video output terminals on your Video source device, you should elect to use the S-Video option.

Least video quality

Composite Video is an analog video and will result in a perfectly acceptable, but less than optimal result from your projector, being the least video quality of the available methods described here.

See "[Connecting an S-Video or a composite Video source device](#)" on page 20 for how to connect the projector to an S-Video or composite Video device.

Connecting a Component Video source device

Examine your Video source device to determine if it has a set of unused Component Video output sockets available:

- If so, you can continue with this procedure.
- If not, you will need to reassess which method you can use to connect to the device.

To connect the projector to a Component Video source device:

1. Take the (optional accessory) Component Video to VGA (D-Sub) adaptor cable and connect the end with 3 RCA type connectors to the Component Video output sockets of the Video source device. Match the color of the plugs to the color of the sockets; green to green, blue to blue, and red to red.
2. Connect the other end of the Component Video to VGA (D-Sub) adaptor cable (with a D-Sub type connector) to the D-SUB socket on the projector.

The final connection path should be like that shown in the following diagram:

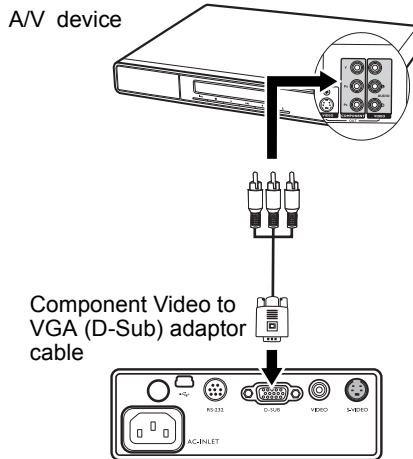

If you connect the projector to a Digital TV (DTV) tuner, the following resolution is supported:

- 480i
- 576i
- 720p (50/ 60 Hz)
- 480p
- 576p
- 1080i (50/ 60 Hz)

- ☞ **Component Video is the only video output that delivers native 16:9 aspect ratio picture.**
- **If the selected video picture is not displayed after the projector is turned on and the correct video source has been selected, check that the Video source device is turned on and operating correctly. Also check that the signal cables have been connected correctly.**

Connecting an S-Video or a composite Video source device

Examine your Video source device to determine if it has an unused S-Video or composite Video output socket available:

- If so, you can continue with this procedure.
- If not, you will need to reassess which method you can use to connect to the device.

If you have already made a Component Video connection between the projector and the video source device, you need not connect to this device again using an S-Video or composite Video connection as this makes an unnecessary second connection of poorer picture quality. You need only connect using a composite Video connection if both Component Video and S-Video are not supplied on the video source device (for example, with some analog video cameras).

See **"Connecting Video source devices"** on page 18 for details.

To connect the projector to an S-Video/Video source device:

1. Take the (optional accessory) S-Video cable/Video cable and connect one end to the S-Video/Video output socket of the Video source device.
2. Connect the other end of the S-Video cable/Video Cable to the S-VIDEO/VIDEO socket on the projector.

The final connection path should be like that shown in the following diagram:

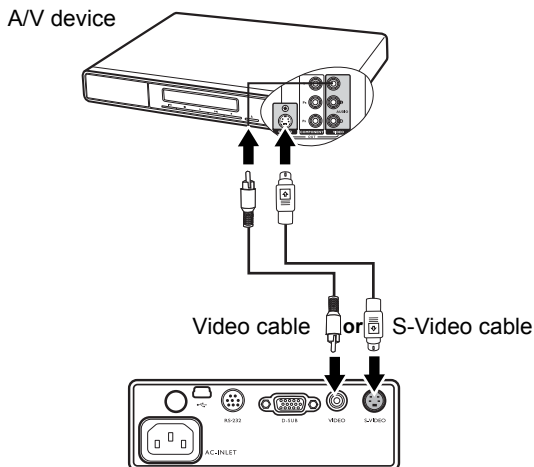

If the selected video picture is not displayed after the projector is turned on and the correct video source has been selected, check that the Video source device is turned on and operating correctly. Also check that the signal cables have been connected correctly.

5. Operation

Start up

1. Plug the power cord into the projector and into a wall socket. Turn on the wall socket switch (where fitted). Check that the **Power indicator** on the projector lights orange after power has been applied.

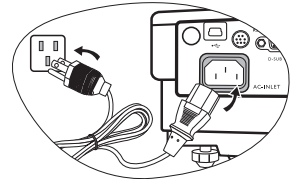

ⓘ The power cable used in the illustration may look different to the power cable type used in your region. Use only the power cable as supplied with the projector, and which is suitable for your region.

2. Remove the lens cap. If it is left on, it could become deformed due to the heat produced by the projector lamp.

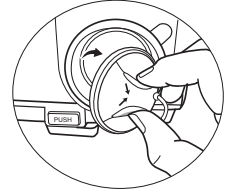

3. Press and hold (for 2 seconds) **Power** on the projector or remote control to start the projector. The **Power indicator light** flashes green and stays green when the projector is on. The start up procedure takes about 30 seconds. In the later stage of start up, a startup logo is projected. (If necessary) Rotate the focus ring to adjust the picture clarity.

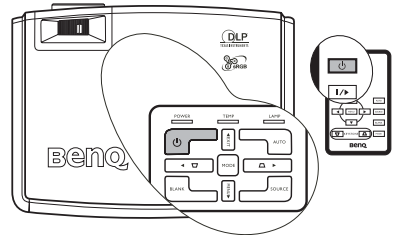

ⓘ If the projector is still hot from previous activity, it will run the cooling fan for approximately 110 seconds before energizing the lamp.

4. If you are prompted for a password, press the arrow buttons to enter a four digit password. See "[Utilizing the password function](#)" on page 22 for details.
5. Switch on all of the connected equipment. The projector will start to search for input signals. The current input source being scanned displays in the center of the screen. If the projector doesn't detect a valid signal, the searching message will continue displaying until an input source signal is found. You can also press **SOURCE** on the projector or remote control to select your desired input signal. See "[Switching input signal](#)" on page 24 for details.

☞ If a PC input is selected and the resolution is not 800 x 600, you will see a Resolution Reminder as below. For a better picture quality, please change the PC's resolution to 800 x 600 as requested.

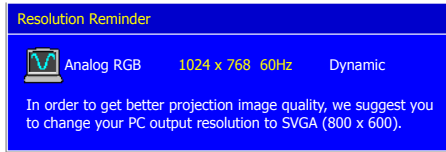

If the frequency/resolution of the input signal exceeds the projector's operating range, you will see the message 'Out of Range' displayed on the screen. Please change to an input signal which is compatible with the projector's resolution or set the input signal to a lower setting. See "Timing chart" on page 49 for details.

Utilizing the password function

For security purposes and to help prevent unauthorized use, the projector includes an option for setting up password security. The password can be set through the On-Screen Display (OSD) menu. For details of the OSD menu operation, please refer to "Using the OSD menus" on page 34.

⚠ You will be inconvenienced if you activate the password functionality and subsequently forget the password. Print out this manual (if necessary) and write the password you used in this manual, and keep the manual in a safe place for later recall.

Setting a password

☞ Once a password has been set and activated, the projector cannot be used unless the correct password is entered every time the projector is started.

1. Press ▼ **MENU** on the projector or **MENU** on the remote control to open the OSD menu and go to the  **Setting > Password** menu. Select **On** by pressing ◀ **Left/Right** ▶.
2. When the function is activated for the first time, a prompt will display on the screen.
3. As pictured to the right, the four arrow buttons (▲ **Up**, ▶ **Right**, ▼ **Down**, ◀ **Left**) respectively represent 4 digits (1, 2, 3, 4). Press the arrow buttons to enter four digits for the password.
4. When all digits are entered and the password is ready, press **AUTO** to confirm.

☞ The digits being input will display as asterisks on-screen. Write your selected password down here in this manual in advance or right after the password is entered so that it is available to you should you ever forget it.

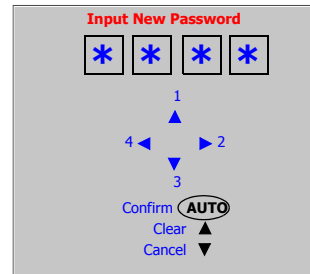

Password: _ _ _ _
Keep this manual in a safe place.

5. Enter the password again for verification.
6. Perform one of the following 3 steps.
 - i. Press **AUTO** to continue. The set-up is finished when the message "Password setup completed" displays.
 - ii. Press ▲ **Up** to clear and re-enter four digits.

- iii. Press **▼ Down** to cancel the password set-up and return to the OSD menu.

To disable password protection, go to the  **Setting > Password** menu after opening the OSD menu system. Select **Off** by pressing **◀ Left** or **▶ Right**.

 **Though the password function is disabled, you need to keep the old password in hand should you ever need to turn the password function back on and change the old password.**

If you forget the password

If the password function is activated, you will be asked to enter the four digit password every time you turn on the projector. If you enter the wrong password, the password error message displays. You can retry by pressing **▲ Up**, or if you did not record the password in this manual, and you absolutely do not remember it, you can use the password recall procedure.

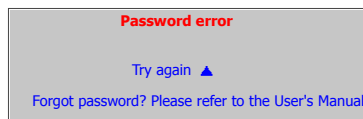

Entering the password recall procedure

Press and hold **▶ Right** on the projector for 3 seconds. The projector will display 4 sets of coded number on the screen. Write down the number and turn off your projector. Seek help from the local BenQ service center to decode the number. You may be required to provide proof of purchase documentation to verify that you are an authorized user of the projector.

Changing the password

1. Press **▼ MENU** on the projector or **MENU** on the remote control to open the on-screen menu and go to the  **Setting > Change Password** menu.
2. Press **◀ Left** or **▶ Right**.
3. Enter the old password.
 - i. If the password is correct, you can go on to enter new password.
 - ii. If the password is incorrect, a “Password Error” message displays. Press **▲ Up** to try again or press **▼ Down** to cancel.
4. Enter a new password.

 **The digits being input will display as asterisks on-screen. Write your selected password down here in this manual in advance or right after the password is entered so that it is available to you should you ever forget it.**

Password: ____
Keep this manual in a safe place.

5. Perform one of the following 3 steps.
 - i. Press **AUTO** to confirm.
 - ii. Press **▲ Up** to try again.
 - iii. Press **▼ Down** to cancel the set-up and return to the on-screen menu.
6. Confirm the new password by re-entering the new password.
7. Perform one of the following 3 steps.
 - i. Pressing **AUTO** completes the procedure.
 - ii. Press **▲ Up** to try again.
 - iii. Press **▼ Down** to cancel the set-up and return to the on-screen menu.

Switching input signal

The projector can be connected to multiple devices at the same time. However, it can only display one at a time.

To cycle through the available input signals:

1. Press **SOURCE** on the projector or the remote control to display a source selection bar. If there has been a signal selected, press **SOURCE** twice. The first button press displays the current source information and the second displays the source selection bar.

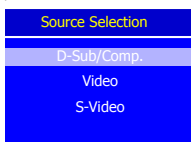
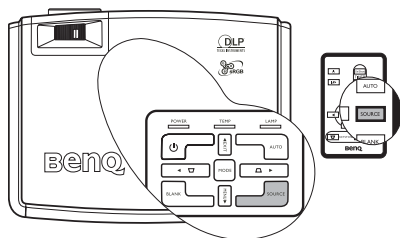

2. You can manually press **SOURCE** repeatedly until your desired signal is selected or let the projector automatically search for the available signal. Once detected, the selected source information will display at the lower right corner of the screen for 3 seconds. If there is multiple equipment connected to the projector, you can press the button again to search for another signal.

Be sure the **Source Scan** function in the  **Advanced** menu is activated if you want the projector to automatically search the signals. See "[Source Scan](#)" on page 38 for details

To prevent unnecessary waste of lamp time, you can activate the Auto Off function to turn off the projector automatically when there is no signal detected after a period of time. To set the Auto Off time, go to the  **Advanced** > **Auto Off** menu and press **◀ Left/ ▶ Right** to set a time from 5 to 20 minutes in 5-minute increments.

 **The brightness level of the projected picture will change accordingly when you switch between different input signals. Data (graphic) "PC" presentations using mostly static pictures are generally brighter than "Video" using mostly moving pictures (movies).**

The input type affects the options available for the Picture Mode. See "[Selecting a picture mode](#)" on page 27 for details.

Adjusting the projected picture

Adjusting the projection angle

The projector is equipped with one quick-release adjuster foot and one rear adjuster foot. These adjusters change the picture height and projection angle. To adjust the projector:

1. Lift the projector up and press the adjuster button to release the adjuster. The adjuster will drop into position and be locked.

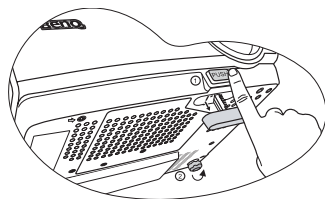

 **Do not look into the lens while the lamp is on. The strong light from the lamp may cause damage to your eyes.**

2. Screw the rear adjuster foot to fine tune the horizontal angle.

To retract the foot, hold up the projector while pressing the quick-release button, then slowly lower the projector. Screw the rear adjuster foot in a reverse direction.

If the screen and the projector are not perpendicular to each other, the projected picture becomes vertically trapezoidal. To correct this situation, adjust the value of Keystone in the Picture menu, on the projector control panel, or on the remote control. See "Correcting keystone" on page 25 for details.

Correcting keystone

Keystoning refers to the situation where the projected picture is noticeably wider at either the top or bottom. It occurs when the projector is not perpendicular to the screen.

To correct this, besides adjusting the height of the projector, you will need to manually correct it following ONE of these steps.

- Press ∇ / \triangle on the projector or remote control to display the status bar labelled Keystone, then press ∇ to correct keystone at the top of the picture or press \triangle to correct keystone at the bottom of the picture.
- Press \blacktriangledown **MENU** on the projector or **MENU** on the remote control. Go to the **Pro-Picture > Keystone** menu and adjust the values by pressing \blacktriangleleft **Left** / \blacktriangleright **Right** on the projector or remote control until you are satisfied with the shape.

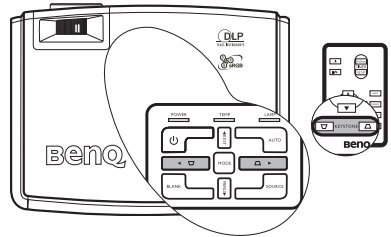

For example,

	<ul style="list-style-type: none"> Press ∇ on the projector or remote control. Press \blacktriangleleft on the projector or remote control when you are in the Pro-Picture > Keystone menu. 	
Keystone 0		Keystone -6
	<ul style="list-style-type: none"> Press \triangle on the projector or remote control. Press \blacktriangleright on the projector or remote control when you are in the Pro-Picture > Keystone menu. 	
Keystone 0		Keystone +6

Auto-adjusting the picture

In some cases like with computer timings, you may need to optimize the picture quality. To do this, press **AUTO** on the projector or remote control. Within 3 seconds, the built-in Intelligent Auto Adjustment function will re-adjust the values of Frequency and Clock to provide the best picture quality.

The current source information will be displayed in the lower right corner of the screen for 3 seconds.

The screen will be blank while AUTO is functioning.

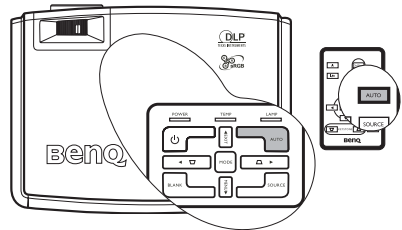

Fine-tuning the picture clarity

If needed, sharpen the picture by rotating the focus ring.

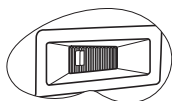
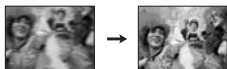



 If you are still not satisfied with the picture clarity, see "[Sharpness](#)" on page 35 to make further adjustment.

Selecting the aspect ratio

The 'aspect ratio' is the ratio of the picture width to the picture height. Most analog TV and computers are in 4:3 ratio, and digital TV and DVDs are usually in 16:9 ratio.

With the advent of digital signal processing, digital display devices like this projector can dynamically stretch and scale the picture output to a different aspect than that of the picture input source.

You can change the projected picture ratio (no matter what aspect the source is) by entering the  **Pro-Picture > Aspect Ratio** menu. Select an aspect ratio to suit the format of the video signal and your display requirements. There are three aspect ratios available:

 In the pictures below, the black portions are inactive areas and the white portions are active areas.

1. **Native:** The picture is projected at its original resolution, with no pixel conversion. For input signals with lower resolutions, the projected picture will display smaller than if resized to full screen. You could move the projector towards the screen to increase the picture size if necessary. You may also need to refocus the projector after moving the projector.
2. **4:3:** Scales a picture so that it is displayed in the center of the screen with a 4:3 aspect ratio. This is most suitable for 4:3 pictures like computer monitors, standard definition TV and 4:3 aspect DVD movies, as it displays them without aspect alteration.
3. **16:9:** Scales a picture so that it is displayed in the center of the screen with a 16:9 aspect ratio. This is most suitable for pictures which are already in a 16:9 aspect, like high definition TV, as it displays them without aspect alteration.

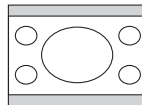
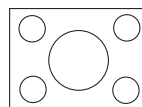
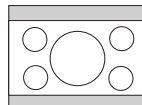

 **16:9 aspect ratio is only sourced through the Component Video input when being fed an appropriate 16:9 aspect signal. See "[Connecting a Component Video source device](#)" on page 19 and "[Obtaining a preferred projected picture size](#)" on page 14 for details.**

Optimizing the picture

Selecting a picture mode

The projector is preset with several predefined picture modes so that you can choose one to suit your operating environment and input source picture type.

To select a picture mode that suits your need, you can follow one of the following steps.

- Press **MODE** on the remote control or projector repeatedly until your desired mode is selected.
- Go to the  **Picture > Picture**

Mode menu and press ◀ **Left** / ▶ **Right** to select a desired mode.

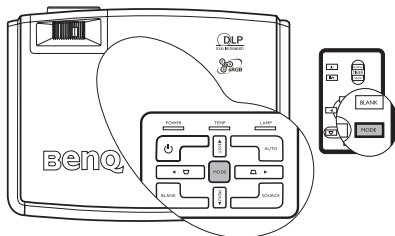

The preset picture modes are stored in the projector along with the current color temperature setting for each input. You can change the picture mode and color temperature settings for the currently active input, and your selection is automatically stored in the projector and associated with that input source.

Each time you change the picture mode, the projector also changes the color temperature setting to the one which was last selected for that particular picture mode on that particular input. If you change the input source, the most recently used picture mode and color temperature for that input and resolution will be restored.

The other picture properties such as brightness, color, contrast, tint, and sharpness, are not changed with a change in picture mode, however, are altered by a change in input. They remain constant and system wide, no matter what other picture properties are changed. See "[Picture menu](#)" on page 35 for details.

The picture modes available for different types of signals are listed below.

■ Graphic input sources

 **Graphic input sources are computer (data) based graphics-card signal timings and are only ever connected using the VGA (D-Sub) cable. Graphic input sources are active only when "RGB" is selected as the input source.**

1. **Dynamic Mode (Default):** Maximizes the brightness of the projected picture. This mode is suitable for environments where extra-high brightness is required, such as using the projector in well lit rooms.
2. **Presentation Mode:** Is designed for presentations. The brightness is emphasized in this mode to match PC and notebook coloring.
3. **sRGB Mode:** Maximizes the purity of RGB colors to provide true-to-life pictures regardless of brightness setting. It is most suitable for viewing photos taken with an sRGB compatible and properly calibrated camera, and for viewing PC graphic and drawing applications such as AutoCAD.
4. **Cinema Mode:** Is appropriate for playing colorful movies, video clips from digital cameras or DVs through the PC input for best viewing in a blackened (little light) environment.

■ Video input sources

 Video input sources are video (movie) based signal timings connected using the video cables Component Video (YPbPr), S-Video, or composite Video. Video input sources are active only when "YPbPr (Comp.)", "S-Video", or "Video" is selected as the input source.

1. **Standard Mode (Default):** Is appropriate for viewing colorful movies, video clips from digital cameras or DVs.
2. **Dynamic Mode:** Is suitable for playing gamebox-based video games in a normal living room lighting level environment.
3. **Cinema Mode:** Is suitable for enjoying dark movies or DVD movies best viewed in a blackened (little light) home cinema or lounge room environment.

Using Wall Color

In the situation where you are projecting onto a colored surface such as a painted wall which may not be white, the Wall Color feature can help correct the projected picture's color to prevent possible color difference between the source and projected pictures.

To use this function, go to the  **Picture > Wall Color** menu and press ◀ **Left/**

▶ **Right** to select a color which is the closest to the color of the projection surface. There are several precalibrated colors to choose from: Light Yellow, Pink, Light Green, Blue, and Blackboard.

 To achieve truly accurate color reproduction in your projected pictures, it is still recommended that you use a properly graded "white" projection screen.

Fine-tuning the picture quality

The following adjustments are accessible in the  **Picture** menu. Highlight the item to be adjusted by pressing ▲ **Up/ ▼ Down** and press ◀ **Left/ ▶ Right** to make adjustments based on your needs.

Selecting a Color Temperature

There are four preset color temperature* settings available.

1. **T1:** With the highest color temperature, T1 makes the picture appear the most bluish white than other settings.
2. **T2:** Makes pictures appear bluish white.
3. **T3:** Maintains normal colorings for white.
4. **T4:** Makes pictures appear reddish white.

*About color temperatures:

There are many different shades that are considered to be "white" for various purposes. One of the common methods of representing white color is known as the "color temperature". A white color with a low color temperature appears to be reddish white. A white color with a high color temperature appears to have more blue in it.

Adjusting Brightness

The higher the value, the brighter the picture. The lower the setting, the darker the picture. Adjust this control so the black areas of the picture appear just as black and that detail in the dark areas is visible.





Adjusting Contrast

The higher the value, the greater the contrast. Adjust this control so that white areas of the picture appear bright and that detail in the white areas remains visible. Use this after you have previously adjusted the Brightness setting to suit your selected input and viewing environment.



Other adjustments

You can find other picture quality fine-tune selections in the  **Picture** menu as well. See "Picture menu" on page 35 for details.

-  **A change of input will cause the projector to restore the picture settings which were current when that input was last selected. If no custom adjustments have been made to the picture settings of that input, the default settings for that input will be used.**

Setting the presentation timer

Presentation timer can indicate the presentation time on the screen to help you achieve better time management when giving presentations. Follow these steps to utilize this function:

1. Press **TIMER SETUP** on the remote control or go to the  **Advanced > Presentation Timer** menu and press **◀ Left/ ▶ Right** to display the Presentation Timer page.

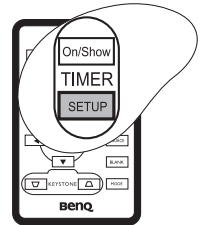
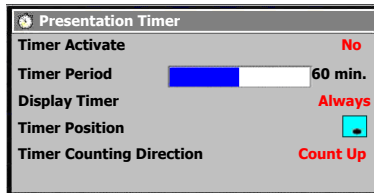

2. Press **▼ Down** to highlight Timer Period and decide the timer period by pressing **◀ Left/ ▶ Right**. The length of time can be set from 5 to 240 minutes in 5-minute increments.

 **If the timer is already on, the timer will restart whenever the Timer Period is reset.**

3. Press **▼ Down** to highlight Display Timer and choose if you want the timer to show up on the screen by pressing **◀ Left/Right ▶**.

Selection	Description
Always	Displays the timer on screen throughout the presentation time.
1 min/2 min/3 min	Displays the timer on screen in the last 1/2/3 minute(s).
Never	Hides the timer throughout the presentation time.

- Press **▼ Down** to highlight Timer Position and set the timer position by pressing **◀ Left/ ▶ Right**.

Upper left → lower left → upper right → lower right

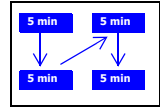

- Press **▼ Down** to highlight Timer Counting Direction and select your desired counting direction by pressing **◀ Left/ ▶ Right**.

Selection	Description
Count Up	Increases from 0 to the preset time.
Count down	Decrease from the preset time to 0.

- Press **▲ Up** to highlight Timer Activate and press **◀ Left/ ▶ Right**. A confirmation message displays.
- Press **▼ Down** to confirm. You will see the message “Timer is on!” displaying on the screen. The timer start counting at the time the timer is on.

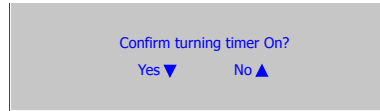

To cancel the timer, repeat steps 1, 6, and 7. You will see the message “Time is up!” displaying on the screen.

How to use the TIMER On/Show button?

The button is a multi-functional key.

- If the presentation timer is off, pressing this button displays a confirmation message. You can decide whether to activate the timer or not by following the on-screen instruction.
- If the timer is already on and hidden, pressing this button displays the timer on the screen for a few seconds.
- If the timer is already on and displays on the screen, pressing this button has no effect.

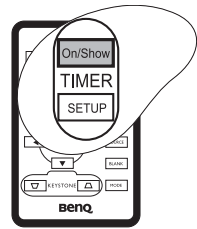

Hiding the picture

In order to draw the audience’s full attention to the presenter, you can use **BLANK** to hide the screen picture. Press any key on the projector or remote control to restore the picture. The word “**BLANK**” appears at the lower right corner of the screen while the picture is hidden.

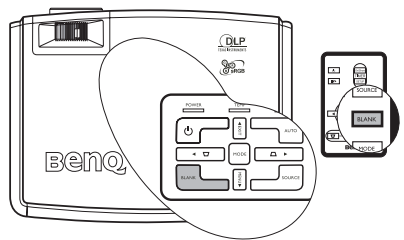

You can set the blank time in the  **Setting > Blank Timer** menu to let the

projector return the picture automatically after a period of time when there is no action taken on the blank screen. The length of time can be set from 0 to 60 minutes in one-minute increments. Selecting 0 minute disables the function.

 **Once **BLANK** is pressed, the projector enters Economic mode automatically.**

 **Do not block the projection lens from projecting as this could cause the blocking object to become heated and deformed or even cause a fire.**

Freezing the picture

Press **||▶** on the remote control to freeze the picture. An icon **||** will display in the lower right corner of the screen. To release the function, press **||▶** on the remote control, or **SOURCE** on the projector. Note that pressing **SOURCE** will also change the input source.

Even if a picture is frozen on the screen, the pictures are running on the video or other device.

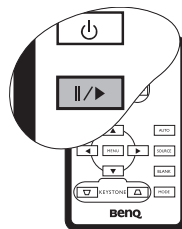

Operating in a high altitude environment

We recommend that you use the High Altitude Mode when your environment is between 1500 m–3000 m above sea level, and temperature is between 0°C–35°C.

⚠ Do not use the High Altitude Mode if your altitude is between 0 m and 1500 m and temperature is between 0°C and 35°C. The projector will be over cooled, if you turn the mode on under such condition.

To activate the High Altitude Mode, go to the  **Advanced > High Altitude Mode** menu, select **On** by pressing **◀ Left/ ▶ Right** on the projector or remote control. A confirmation message displays. Press **▼ Down**.

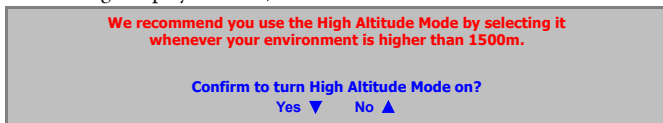

Next time you turn on the projector, it will show a message pictured below as a reminder during the start-up.

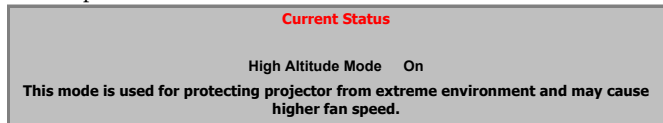



Operation under "High Altitude Mode" may cause a higher decibel operating noise level because of increased fan speed necessary to improve overall system cooling and performance.

If you use this projector under other extreme conditions excluding the above, it may display auto shut-down symptoms, which is designed to protect your projector from over-heating. In cases like this, you should switch to High Altitude mode to solve these symptoms. However, this is not to state that this projector can operate under any and all harsh or extreme conditions.

Shutting down the projector

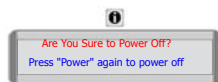
1. Press **Power** and a prompt message appears. Press **Power** a second time to turn the projector off.
2. The **Power indicator light** flashes orange and the lamp shuts down, the fans continue to run for approximately 110 seconds to cool down the projector.



 **To protect the lamp, the projector will not respond to any commands during the cooling process.**

3. If the projector will not be used for a long period of time, disconnect the power cord from the wall socket.



• **Do not unplug the power cord before the projector shutdown sequence is complete or during the 110-second cooling down process.**

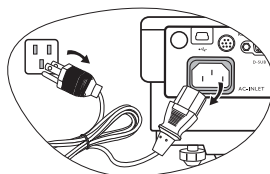





- **If the projector is not properly shut down, to protect the lamp, when you attempt to re-start the projector, the fans will run for a few minutes to cool down. Press Power again to start the projector after the fans stop and the Power indicator light turns orange.**

Menu operation

Menu system

Please note that the on-screen display (OSD) menus vary according to the signal type selected.

Functions available when receiving different signal types...			
Sub-Menu	PC	Video / S-Video	Component Video
 Picture	<ul style="list-style-type: none"> • Picture Mode • Wall Color • Color Temperature • Brightness • Contrast 	<ul style="list-style-type: none"> • Picture Mode • Wall Color • Color Temperature • Brightness • Contrast • Color • Tint* • Sharpness 	
 Pro-Picture	<ul style="list-style-type: none"> • Auto Resize • Aspect Ratio • Keystone • Horizontal Position • Vertical Position • Phase • Horizontal Size 	<ul style="list-style-type: none"> • Auto Resize • Aspect Ratio • Keystone 	
 Setting	<ul style="list-style-type: none"> • OSD Time • Blank Timer • Password • Change Password • Reset 		
 Advanced	<ul style="list-style-type: none"> • Mirror • Source Scan • Language • Splash Screen • High Altitude Mode • Auto Off • Economic Mode • Presentation Timer 		
 Information	<ul style="list-style-type: none"> • Source • Resolution • Picture Mode • Equivalent Lamp Hour 	<ul style="list-style-type: none"> • Source • System • Picture Mode • Equivalent Lamp Hour 	<ul style="list-style-type: none"> • Source • Resolution • Picture Mode • Equivalent Lamp Hour

*When a Video or S-Video signal is connected, the function is only available with NTSC system selected.

Using the OSD menus

The projector is equipped with on-screen display (OSD) menus for making various adjustments and settings.

There are 17 different menu languages. (Refer to "Language" on page 38 for more details.)

The following example describes the adjustment of **Keystone**.

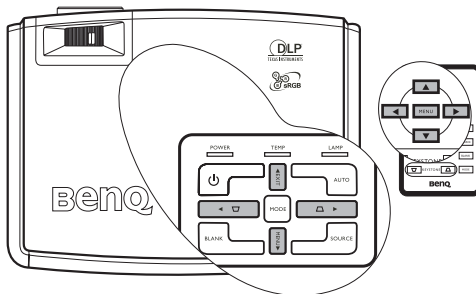

1. Press **▼ MENU** on the projector or **MENU** on the remote control to turn the OSD menu on.
4. Adjust keystone values by pressing **◀ Left/ ▶ Right** on the projector or remote control.

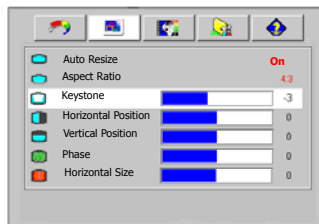
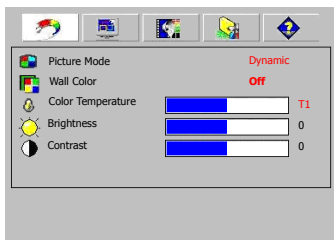

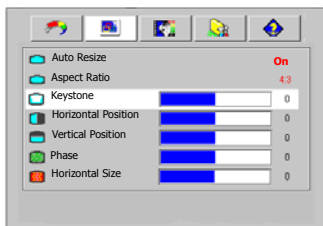

2. Use **◀ Left/ ▶ Right** on the projector or remote control to select the **Pro-Picture** menu. 
3. Press **▲ Up/ ▼ Down** on the projector or remote control to select **Keystone**.
5. Press **▲ EXIT** on the projector repeatedly or press **MENU** on the remote control to leave and save the setting.









Picture menu

 Some picture adjustments are available only when certain input sources are in use. Unavailable adjustments are not shown on the screen.

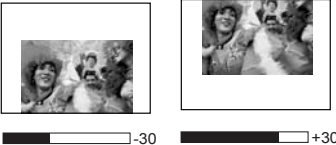

FUNCTION (default setting / value)	DESCRIPTION
Picture Mode (PC: Dynamic; YPbPr/S-Video/ Video: Standard)	Pre-defined modes are provided so you can optimize your projector picture set-up to suit your program type.  You can use the remote control MODE button to select a predefined Picture Mode. See "Selecting a picture mode" on page 27 for details.
Wall Color (Off)	Correct the projected picture's color when the projection surface is not white.
Color Temperature (depends on the selected Picture Mode)	There are four color temperature settings available. See "Selecting a Color Temperature" on page 28 for details.
Brightness (depends on the selected input source)	Adjusts the brightness of the picture. See "Adjusting Brightness" on page 28 for details.
Contrast (depends on the selected input source)	Adjusts the degree of difference between dark and light in the picture. See "Adjusting Contrast" on page 29 for details.
Color (depends on the selected input source)	Increases or decreases the color intensity of the picture.
Tint (50)	Adjusts the color tones of the picture. The higher the value, the more reddish the picture becomes. The lower the value, the more greenish the picture becomes.  When a Video or S-Video signal is connected, the function is only available with NTSC system selected.
Sharpness (15)	Adjusts the picture to make it look sharper or softer.

Pro-Picture menu



 Some picture adjustments are available only when certain input sources are in use. Unavailable adjustments are not shown on the screen.

FUNCTION (default setting/ value)	DESCRIPTION
Auto Resize (On)	<p>Automatically resizes the input signal pixel resolution to the native resolution of the projector.</p> <p>On: The pixel resolution of the input signal is converted to the native resolution of the projector (800 x 600). For input signals with lower resolutions, gaps in the pixels are automatically interpolated into the picture before being projected. This may distort the picture clarity.</p> <p>Off: The picture is projected as its original resolution, with no pixel conversion. For input signals with lower resolutions, the projected picture will display smaller than if resized to full screen. You could move the projector towards the screen to increase the picture size if necessary. You may also need to refocus the projector after moving the projector.</p> <p> The projector is always started with the default setting of this function and will not save and store the last change you make to it.</p>
Aspect Ratio (Native)	<p>There are three options to set the picture's aspect ratio depending on your input signal source.</p> <p>See "Selecting the aspect ratio" on page 26 for details.</p>
Keystone (0)	<p>Corrects any keystone of the picture. See "Correcting keystone" on page 25 for details.</p>
Horizontal Position (0)	<p>Adjusts the horizontal position of the projected picture.</p> <div style="display: flex; justify-content: space-around; align-items: center;">   </div>
Vertical Position (0)	<p>Adjusts the vertical position of the projected picture.</p> <div style="display: flex; justify-content: space-around; align-items: center;">   </div>
Phase (depends on the selected input source)	<p>Adjusts the video input clock to synchronize with the video signal. This helps reduce picture distortion produced by some PC video timings.</p> 
Horizontal Size (0)	<p>Adjusts the horizontal width of the picture.</p>

Setting menu

FUNCTION (default setting / value)	DESCRIPTION
OSD Time (20)	Sets the length of time the OSD will remain active after your last button press. The range is from 5 to 100 seconds.
Blank Timer (20)	Sets the picture blank time when the Blank feature is activated, once elapsed the picture will return to the screen.
Password (Off)	<p>This is a selectable function. Selecting On limits use of the projector to only those who know the correct password. When the function is activated for the first time, you have to set a password for it. For more information, refer to "Utilizing the password function" on page 22. Once the password is set and this function is selected, the projector is password-protected. Users who do not know the correct password can not use the projector.</p> <p> You will be inconvenienced if you activate the password functionality and subsequently forget the password. Print out this manual (if necessary) and write the password you used in this manual, and keep the manual in a safe place for later recall.</p> <p>The password can be entered by using either the buttons on the projector or the remote control.</p> <p> The digits being input will display as asterisks on-screen.</p>
Change Password	You will be asked to enter the current password before changing to a new one. For more information, refer to "Utilizing the password function" on page 22 .
Reset (No)	Returns all settings to the factory preset values.

Advanced menu

FUNCTION (default setting / value)	DESCRIPTION (default setting / value)
Mirror ()	The projector can be installed on a ceiling or behind a screen, or with one or more mirrors. Contact your dealer for the ceiling mount bracket (optional accessory) if you need to install the projector on your ceiling. See "Choosing a location" on page 13 for details.
Source Scan (On)	Sets whether the projector searches automatically for input signals. If the source scan is On , the projector will scan for input signals until it acquires a signal. If the function is not activated, the projector selects the last used input signal. The default value is 'RGB'.
Language (English)	Sets the language for the OSD menus. There are 17 languages for your choice: English (default), French, German, Italian, Spanish, Russian, Traditional Chinese, Simplified Chinese, Japanese, Korean, Swedish, Dutch, Turkish, Czech, Portuguese, Thai, and Polish.
Splash Screen (BenQ logo)	Select which logo screen will display during projector start-up. Three modes are available: BenQ logo, Black screen, and Blue screen.
High Altitude Mode (Off)	A mode for operation in areas like high altitude or high temperature. See "Operating in a high altitude environment" on page 31 for details.
Auto Off (Off)	Sets the projector to turn off automatically if no input signal is detected after a set period of time. See "Switching input signal" on page 24 for details.
Economic Mode (Off)	Use this mode to reduce system noise and reduce power consumption by 20%. If this mode is activated, the light output will be reduced and result in darker projected pictures.  Setting the projector in Economic mode extends the lamp timer automatic shutdown feature. For details on how the total lamp hour is calculated, see "Calculation of lamp hour" on page 41.
Presentation Timer	Reminds the presenter to finish the presentation within a certain time frame. See "Setting the presentation timer" on page 29 for details. Timer Activate (Off): Turns the presentation timer on or off. Timer Period (60 min.): Sets a preferred length of time for presentation. Display Timer (Always): Sets whether to display the timer on screen. Timer Position () : Sets the position where the timer displays on screen. Timer Counting Direction (Count Up): Sets the timer counting direction.

Information menu

This menu shows you the current operating status of the projector.

 **Some picture adjustments are available only when certain input sources are in use. Unavailable adjustments are not shown on the screen.**

FUNCTION	DESCRIPTION
Source	Shows the current signal source.
Resolution	Shows the resolution of the input signal.
System	Shows the Video input system format, NTSC, SECAM or PAL.
Picture Mode	Shows the selected mode in the  Picture menu.
Equivalent Lamp Hour	Displays the equivalent lamp hour calculated by the built-in timer.

6. Maintenance

Care of the projector

Your projector needs little maintenance. The only thing you need to do on a regular basis is to keep the lens clean.

Never remove any parts of the projector except the lamp. Contact your dealer if other parts need replacing.

Cleaning the lens

Clean the lens whenever you notice dirt or dust on the surface.

- Use a canister of compressed air to remove dust.
- If there is dirt or smears, use lens-cleaning paper or moisten a soft cloth with lens cleaner and gently wipe the lens surface.

 **Never rub the lens with abrasive materials.**

Cleaning the projector case

Before you clean the case, turn the projector off using the proper shutdown procedure as described in "[Shutting down the projector](#)" on page 32 and unplug the power cord.

- To remove dirt or dust, wipe the case with a soft, lint-free cloth.
- To remove stubborn dirt or stains, moisten a soft cloth with water and a neutral pH detergent. Then wipe the case.

 **Never use wax, alcohol, benzene, thinner or other chemical detergents. These can damage the case.**

Storing the projector

If you need to store the projector for an extended time, please follow the instructions below:

- Make sure the temperature and humidity of the storage area are within the recommended range for the projector. Please refer to "[Specifications](#)" on page 48 or consult your dealer about the range.
- Retract the adjuster feet.
- Remove the battery from the remote control.
- Pack the projector in its original packing or equivalent.

Transporting the projector

It is recommended that you ship the projector with its original packing or equivalent. When you carry the projector yourself, please use the original box or a soft carry case which is available from your BenQ dealer.

Lamp information

Calculation of lamp hour

When the projector is in operation, the duration (in hours) of lamp usage is automatically calculated by the built-in timer. The method of calculating the equivalent lamp hour is as follows:

Total (equivalent) lamp hour
= 1 (hours used in Economic mode) + 3/2 (hours used in normal mode)

 See **"Economic Mode" on page 38 for more information on Economic mode.**

The lamp hour in Economic mode is calculated as 2/3 of that in normal mode. That is, using the projector in Economic mode helps to extend the lamp life by 1/2.

Warning message

When the **Lamp indicator** lights up red or a message appears suggesting it is time to replace the lamp, please install a new lamp or consult your dealer. An old lamp may cause a malfunction in the projector and in some instances the lamp may explode.

For more detailed information on projector warnings, please refer to **"Indicators" on page 45.**

 **The Lamp indicator light and Temperature warning light will light up if the lamp becomes too hot. Turn the power off and let the projector cool for 45 minutes. If the Lamp or Temp indicator still lights up after turning the power back on, please contact your dealer.**

The following Lamp warning displays will remind you to change the lamp.

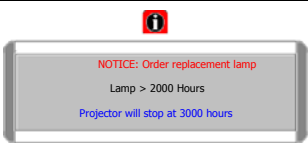
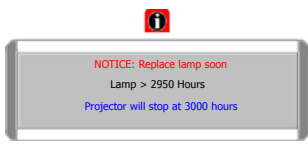
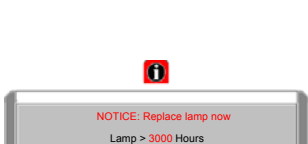
Message	Status
	Total (equivalent) lamp hour has reached 2000 hours. Install a new lamp for optimal performance. If the projector is normally run with "Economic Mode" selected (See "Economic Mode" on page 38), you may continue to operate the projector until the 2950 hour lamp warning appears.
	Total (equivalent) lamp hour has reached 2950 hour. A new lamp should be fitted to avoid the inconvenience when the projector runs out of lamp time.
	Total (equivalent) lamp hour has reached 3000 hours. This message will flash in the center of the screen for about 30 seconds together with the Lamp indicator lighting up red for 40 seconds. It is strongly recommended that you replace the lamp at this age. The lamp is a consumable item. With the usage time increase, the lamp brightness diminished gradually. This is normal lamp behavior. You can replace the lamp whenever you notice that the brightness level has significantly diminished. If the lamp is not replaced beforehand, it must be replaced after 3000 hours usage.



If this warning message displays, the projector will shut down in 40 seconds. The lamp **MUST** be replaced before the projector will operate normally.

Replacing the lamp



- **To reduce the risk of electrical shock, always turn the projector off and disconnect the power cord before changing the lamp.**
- **To reduce the risk of severe burns, allow the projector to cool for at least 45 minutes before replacing the lamp.**
- **To reduce the risk of injuries to fingers and damage to internal components, use caution when removing lamp glass that has shattered into sharp pieces.**
- **To reduce the risk of injuries to fingers and/or compromising picture quality by touching the lens, do not touch the empty lamp compartment when the lamp is removed.**
- **This lamp contains mercury. Consult your local hazardous waste regulations to dispose of this lamp in a proper manner.**

1. Turn the power off and disconnect the projector from the wall socket. If the lamp is hot, avoid burns by waiting for approximately 45 minutes until the lamp has cooled.
2. Turn the projector over. Then loosen the screws on the lamp cover.

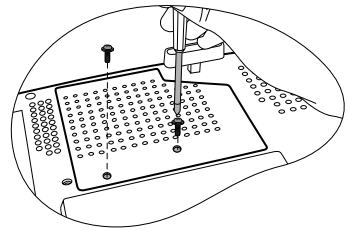

3. Remove the lamp cover from the projector.



Do not turn the power on with the lamp cover removed.

4. Remove the lamp cords from the slots.

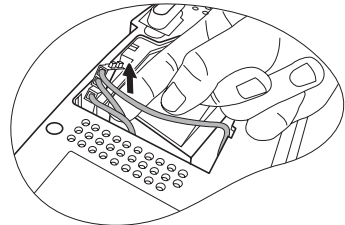
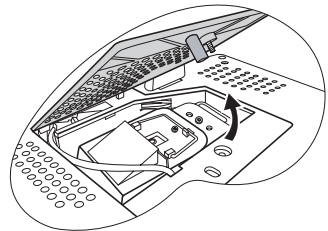

5. Disconnect the lamp connector by pushing it against the projector while pulling it up.

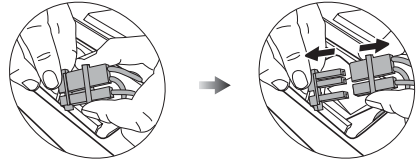

6. Loosen the screw that secures the lamp.

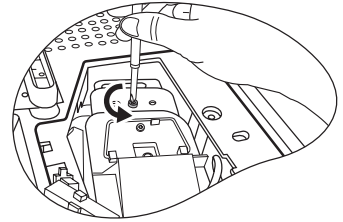

7. Lift the handle so that it stands up. Use the handle to slowly pull the lamp out of the projector.



- **Pulling it too quickly may cause the lamp to break and scatter broken glass in the projector.**

- **Do not place the lamp in locations where water might splash on it, children can reach it, or near flammable materials.**

- **Do not insert your hands into the projector after the lamp is removed. If you touch the optical components inside, it could cause color unevenness and distortion of the projected pictures.**

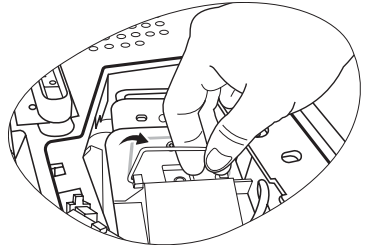

8. As shown in the figure, hold the new lamp first and align the lamp with the compartment in the projector, and then insert the lamp all the way into the projector.

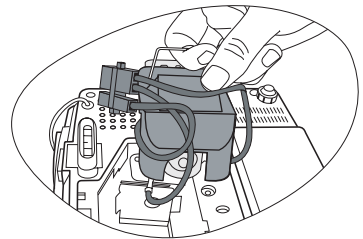

9. Tighten the screw that secures the lamp.



- **Loose screw may cause a bad connection, which could result in malfunction.**

- **Do not over tighten the screw.**

10. Connect the lamp connector to the projector.

11. Place the lamp cords back to the slots.

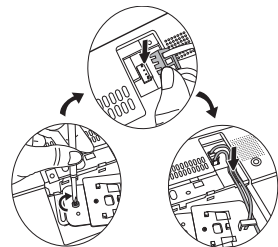

12. Replace the lamp cover on the projector.

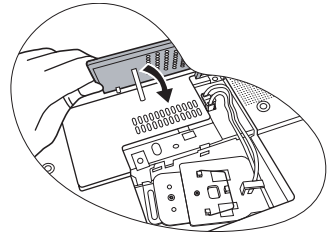

13. Tighten the screws that secure the lamp cover.

- ☞ • **Loose screw may cause a bad connection, which could result in malfunction.**
- **Do not over tighten the screws.**

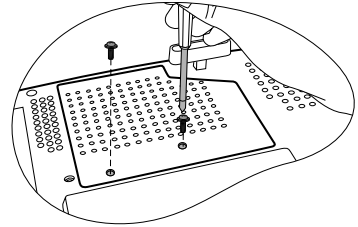

14. Restart the projector.

- ☞ **Do not turn the power on with the lamp cover removed.**

15. Resetting the lamp counter

- ⚠ **Do not reset if the lamp is not replaced as this could cause damage.**

- i. Press and hold **▲ Up** on the projector for 5 seconds to display the total used lamp time.
- ii. Press **AUTO** on the projector or on the remote control to reset the lamp hour to “0”.
- iii. Wait about 5 seconds to let the OSD disappear.

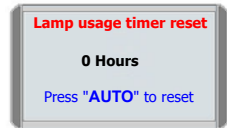

Temperature information



When the Temperature warning light is on, it is warning you of the following possible problems:











1. The internal temperature is too high.
2. The fans are not working.

Turn the projector off and contact qualified service personnel for further help. For more detailed information, please refer to ["Indicators" on page 45](#).

Indicators

Illustration

- **Blank** -: Light OFF
- : Light flashing
- : Light ON
- **O**: Orange light
- **R**: Red light
- **G**: Green light

Light			Status & Description
Power	Temp	Lamp	
Power events			
			The projector has just been connected to a power outlet.
	-	-	Stand-by mode.
	-	-	Powering up.
	-	-	Normal operation.
	-	-	1. The projector needs 90 seconds to cool down as it was abnormally shut down without the normal cooling down process. Or 2. The projector needs to cool for 90 seconds after the power is turned off.
	-	-	The projector has shutdown automatically. If you try to re-start the projector, it will shutdown again. Please contact your dealer for assistance.
Lamp events			
	-		The projector has shutdown automatically. If you try to re-start the projector, it will shutdown again. Please contact your dealer for assistance.
-	-		1. The projector needs 90 seconds to cool down. Or 2. Please contact your dealer for assistance.

Light			Status & Description
Power	Temp	Lamp	
Thermal events			
-	R	-	The projector has shutdown automatically. If you try to re-start the projector, it will shutdown again. Please contact your dealer for assistance.
-	R	R	
-	R	G	
	R	O	
R	R	R	
R	R	G	
R	R	O	
G	R	R	
G	R	G	
G	R	O	
O	R	R	
O	R	G	
O	R	O	
-	G	R	
-	G	G	

7. Troubleshooting

② The projector does not turn on.

Cause	Remedy
There is no power from the power cable.	Plug the power cord into the AC inlet on the projector, and plug the power cord into the power outlet. If the power outlet has a switch, make sure that it is switched on.
Attempting to turn the projector on again during the cooling process.	Wait until the cooling down process has completed.

② No picture

Cause	Remedy
The video source is not turned on or connected correctly.	Turn the video source on and check that the signal cable is connected correctly.
The projector is not correctly connected to the input source device.	Check the connection.
The input signal has not been correctly selected.	Select the correct input signal by pressing SOURCE on the projector or remote control.
The lens cap is still attached to the lens.	Remove the lens cap.

② Blurred picture

Cause	Remedy
The projection lens is not correctly focused.	Adjust the focus of the lens using the focus ring.
The projector and the screen are not aligned properly.	Adjust the projection angle and direction as well as the height of the unit if necessary.
The lens cap is still attached to the lens.	Remove the lens cap.

② Remote control does not work

Cause	Remedy
The battery is out of power.	Replace the battery with a new one.
There is an obstacle between the remote control and the projector.	Remove the obstacle.
You are too far away from the projector.	Stand within 6 meters (19.5 feet) of the projector.

② The password is incorrect

Cause	Remedy
You do not remember the password.	Please see "Entering the password recall procedure" on page 23 for details.

8. Specifications

Projector specifications

 All specifications are subject to change without notice.

General

Product name Digital Projector
Model name MP510

Optical

Resolution 800 x 600 SVGA
Display system 1-CHIP DMD
Lens F/Number F=2.57 (fixed)
Lamp 160 W lamp

Electrical

Power supply AC100–240V, 2.5A, 50–60 Hz (Automatic)
Power consumption 250 W (Max)

Mechanical

Weight 5.7 lbs (2.6 Kg)

Input terminal

Computer input
 RGB input D-Sub 15-pin (female) x 1
Video signal input
 S-VIDEO Mini DIN 4-pin port x 1
 VIDEO RCA jack x1
HDTV signal input D-sub <--> Component RCA jack x 3, through RGB input

Control (for servicing)

USB mouse connector A/B series x 1
RS-232 serial control mini Din 9 pin x 1

Environmental Requirements

Operating temperature 0°C ~ 40°C at sea level
Operating relative humidity 10% ~ 90% (without condensation)
Operating altitude 0–1499 m at 0°C–35°C
1500–3000 m at 0°C–30°C (with High Altitude Mode on)

Dimensions

277 mm (W) x 95 mm (H) x 208 mm (D)

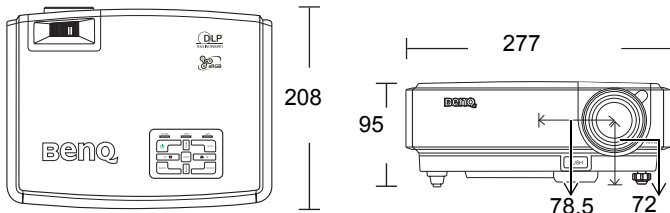

Timing chart

Supported timing for PC input

Resolution	Horizontal Frequency (kHz)	Vertical Frequency (Hz)	Pixel Frequency (MHz)	Mode
640 x 480	31.469	59.940	25.175	VGA_60
	37.861	72.809	31.500	VGA_72
	37.500	75.000	31.500	VGA_75
	43.269	85.008	36.000	VGA_85
720 x 400	31.469	70.087	28.322	720 x 400_70
800 x 600	37.879	60.317	40.000	SVGA_60
	48.077	72.188	50.000	SVGA_72
	46.875	75.000	49.500	SVGA_75
	53.674	85.061	56.250	SVGA_85
1024 x 768	48.363	60.004	65.000	XGA_60
	56.476	70.069	75.000	XGA_70
	60.023	75.029	78.750	XGA_75
	68.667	84.997	94.500	XGA_85
1280 x 1024	63.981	60.020	108.000	SXGA_60

Supported timing for Component-YPbPr input

Signal Format	Horizontal Frequency (kHz)	Vertical Frequency (Hz)
480i(525i)@60Hz	15.73	59.94
480p(525p)@60Hz	31.47	59.94
576i(625i)@50Hz	15.63	50.00
576p(625p)@50Hz	31.25	50.00
720p(750p)@60Hz	45.00	60.00
720p(750p)@50Hz	37.50	50.00
1080i(1125i)@60Hz	33.75	60.00
1080i(1125i)@50Hz	28.13	50.00

Supported timing for Video and S-Video inputs

Video mode	Horizontal Frequency (kHz)	Vertical Frequency (Hz)	Color sub-carrier Frequency (MHz)
NTSC	15.73	60	3.58
PAL	15.63	50	4.43
SECAM	15.63	50	4.25 or 4.41
PAL-M	15.73	60	3.58
PAL-N	15.63	50	3.58
PAL-60	15.73	60	4.43
NTSC4.43	15.73	60	4.43

9. Warranty and Copyright information

Limited warranty

BenQ warrants this product against any defects in material and workmanship, under normal usage and storage.

Proof of purchase date will be required with any warranty claim. In the event this product is found to be defective within the warranty period, BenQ's only obligation and your exclusive remedy shall be replacement of any defective parts (labor included). To obtain warranty service, immediately notify the dealer from which you purchased the product of any defects.

Important: The above warranty shall be void if the customer fails to operate the product in accordance with BenQ's written instructions, especially the ambient humidity must be in-between 10% and 90%, temperature in-between 0°C and 40°C, altitude lower than 10000 feet, and avoiding to operate the projector in a dusty environment. This warranty gives you specific legal rights, and you may have other rights which vary from country to country.

For other information, please visit BenQ.com.

Copyright

Copyright 2006 by BenQ Corporation. All rights reserved. No part of this publication may be reproduced, transmitted, transcribed, stored in a retrieval system or translated into any language or computer language, in any form or by any means, electronic, mechanical, magnetic, optical, chemical, manual or otherwise, without the prior written permission of BenQ Corporation.

Disclaimer

BenQ Corporation makes no representations or warranties, either expressed or implied, with respect to the contents hereof and specifically disclaims any warranties, merchantability or fitness for any particular purpose. Further, BenQ Corporation reserves the right to revise this publication and to make changes from time to time in the contents hereof without obligation to notify any person of such revision or changes.

*DLP, Digital Micromirror Device and DMD are trademarks of Texas Instruments. Others are copyrights of their respective companies or organizations.

10. Regulation statements

FCC statement

CLASS B: This equipment generates, uses and can radiate radio frequency energy and, if not installed and used in accordance with the instructions, may cause harmful interference to radio communications. However, there is no guarantee that interference will not occur in a particular installation. If this equipment does cause harmful interference to radio or television reception, which can be determined by turning the equipment off and on, the user is encouraged to try to correct the interference by one or more of the following measures:

- Reorient or relocate the receiving antenna.
- Increase the distance between the equipment and receiver.
- Connect the equipment into an outlet on a circuit different from that to which the receiver is connected.
- Consult the dealer or an experienced radio/TV technician for help.

EEC statement

This machine was tested against the 89/336/EEC (European Economic Community) for EMC (Electronic Magnetic Compatibility) and fulfills these requirements.

MIC statement

B class equipment (Household purpose info/telecommunications equipment)

This equipment has undergone EMC registration for household purpose, and can be used in any area including residential area.

WEEE directive

Disposal of Waste Electrical and Electronic Equipment by users in private households in the European Union.

This symbol on the product or on the packaging indicates that this can not be disposed of as household waste. You must dispose of your waste equipment by handing it over to the applicable take-back scheme for the recycling of electrical and electronic equipment. For more information about recycling of this equipment, please contact your city office, the shop where you purchased the equipment or your household waste disposal service. The recycling of materials will help to conserve natural resources and ensure that it is recycled in a manner that protects human health and environment.

