

3M

MP8030 Multimedia Projector Operator's Guide

MP8030 Appareil de projection multimédia Guide de l'opérateur

MP8030 Multimedia-Projektor Bedienerhandbuch

Portatil Multimedia MP8030 Manual del usuario

MP8030 Proiettore multimedia Manuale dell'operatore

MP8030 Multimedia-Projektor Instruktionsbok

MP8030 Multimedia Projector Gebruiksaanwyzing

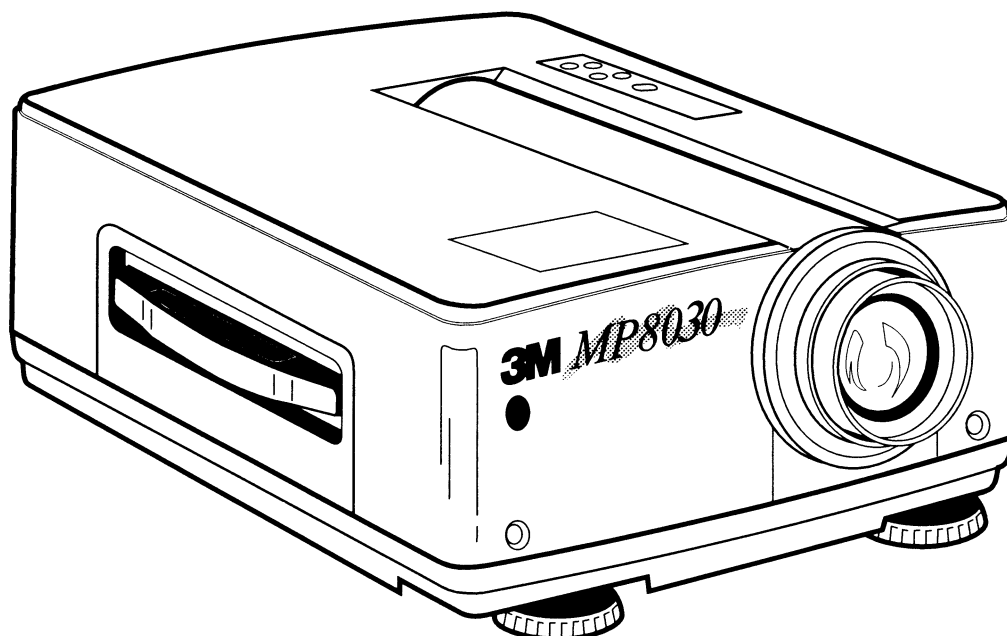



Table of Contents

Table of Contents

Warranty	1
Safeguards	2
Section 1: Unpack	3
1-1. Contents of Shipping Box	3
1-2. Keep Your Packing Materials	3
1-3. What's Next?	3
Section 2: Product Description	4
2-1. Machine Characteristics	4
2-2. Parts Identification List	4
Section 3: Setup	5
3-1. Cable Connections	5
3-2. Projector SetUp	7
3-3. Now What?	9
Section 4: Operating the Projector	10
4-1. Turning On the Projector	10
4-2. Turning Off the Projector	11
4-3. Memory Function/Factory Defaults	11
4-4. Adjusting the Picture	12
4-5. Using System Menus	12
4-6. Setup Menu (RGB and Video Picture)	13
4-7. Input Menu	14
4-7-1. Selecting the Input Source	14
4-8. Image Menu	14
4-8-1. Inverting the Image	14
4-8-2. Changing the Screen Background Color (Blank Button)	14
4-8-3. Changing the Screen Reveal Rate	15
4-8-4. Changing the Menu Size	15
4-8-5. Display Startup Screen/Error Message	15
4-9. Options (OPT.) Menu	16
4-9-1. Communication Speed	16
4-9-2. Communication Bits	16
4-9-3. Mouse Speed	16
4-9-4. Set Countdown Timer	17
4-9-5. Language	17
4-9-6. Auto Power Off	17
Section 5: Remote Control	18
5-1. How to Operate the Remote Control	18



Section 6: Lamp Replacement	19
6-1. Metal Halide Projector Lamp	19
6-2. Replacing the Lamp	19
Section 7: Maintenance	21
7-1. Cleaning	21
Section 8: Troubleshooting	23
8-1. Service Information	23
Section 9: Technical Specifications	24
9-1. Specifications	24
9-2. Projector-to-Screen Distances	24
9-3. Physical Dimensions	25
9-4. Computer Video (RGB) Input Signal	25
9-5. Computer Video (RGB) Input Terminal	26
9-6. S-Video Input Signal Terminal	26
9-7. RS-232 Cable (Mouse Control)	26
Section 10: Accessories	27
10-1. Multimedia Projector Accessories	27



THANK YOU FOR CHOOSING 3M

Thank you for choosing 3M multimedia projection equipment. This product has been produced in accordance with 3M's highest quality and safety standards to ensure smooth and troublefree use in the years to come.

For optimum performance, please follow the operating instructions carefully. We hope you will enjoy using this high performance product in your meetings, presentations and training sessions.

LIMITED WARRANTY

3M warrants this product against any defects in material and workmanship, under normal use and storage, for a period of one year from date of purchase. Proof of purchase date will be required with any warranty claim. In the event this product is found to be defective within the warranty period, 3M's only obligation and your exclusive remedy shall be replacement of any defective parts (labor included).

To obtain warranty service, immediately notify the dealer from which you purchased the product of any defects. The dealer has the option of repairing the product or returning it to 3M for repair or replacement. In the USA call 1-800-328-1371 for warranty or repair service.

LIMITATION OF LIABILITY

THE FOREGOING WARRANTY IS MADE IN LIEU OF ALL OTHER WARRANTIES, EXPRESSED OR IMPLIED, AND 3M SPECIFICALLY DISCLAIMS ANY IMPLIED WARRANTY OF MERCHANTABILITY AND FITNESS. 3M SHALL NOT BE LIABLE FOR ANY DAMAGES, DIRECT, CONSEQUENTIAL, OR INCIDENTAL, ARISING OUT OF THE USE OR INABILITY TO USE THIS PRODUCT.

Important: The above warranty shall be void if the customer fails to operate product in accordance with 3M's written instructions. This warranty gives you specific legal rights and you may have other rights which vary from state to state.

FCC STATEMENT – CLASS A: This equipment generates, uses and can radiate radio frequency energy, and if not installed and used in accordance with the instruction manual may cause interference to radio communications. It has been tested and found to comply with the limits for a Class "A" computing device pursuant to Subpart B of Part 15 of the FCC Rules, which are designed to provide reasonable protection against such interference when operated in a commercial environment. Operation of this equipment in a residential area is likely to cause interference in which case the user at his/her own expense will be required to take whatever measures may be required to correct the interference.

EEC STATEMENT: This machine was tested against the 89/336/EEC (European Economic Community) for EMC (Electro Magnetic Compatibility) and fulfills these requirements.

Video signal cables: Double shielded coaxial cables (FCC shield cable) must be used and the outer shield must be connected to the ground. If normal coaxial cables are used, the cables must be enclosed in metal pipes or in a similar way to reduce the interference noise radiation.

Power Cord: A shielded power cord (supplied) must be used. The outer shield must be connected to the ground.

Video inputs: The input signal amplitude must not exceed the specified level. See Section 9.

IBM is a registered trademark of **International Business Machines Corporation**. MAC II is a registered trademark of **Apple Computer, Inc**. All other products are trademarks or registered trademarks of their respective companies.







IMPORTANT SAFEGUARDS

1. Read and understand all instructions before using. Pay particular attention to areas where this symbol  is shown.

 **WARNING** — Indicates a potentially hazardous situation which, if not avoided, could result in death or serious injury.

 **Caution** — Indicates a potentially hazardous situation which, if not avoided, could result in minor or moderate injury. It may also be used to alert against unsafe practices.

2. Close supervision is necessary when any appliance is used by or near children. Do not leave appliance unattended while in use.
3. Never look directly into the projector lens when the lamp is on. The metal halide lamp produces a strong light which could damage your eyesight.
-  4. Care must be taken as burns can occur from touching hot parts.
5. Do not operate appliance with a damaged cord or if the appliance has been dropped or damaged — until it has been examined by a qualified service technician.
-  6. Position the cord so that it will not be tripped over, pulled or contact hot surfaces.
7. If an extension cord is necessary, a cord with a current rating at least equal to that of the appliance should be used. Cords rated for less amperage than the appliance may overheat.
8. Always unplug appliance from electrical outlet before cleaning and servicing and when not in use. Grasp plug and pull to disconnect.
-  9. Let appliance cool completely before putting away or when replacing lamp. Loop cord loosely around appliance when storing.
10. Disconnect this unit from its source of supply before replacing the projection lamp.
11. To reduce the risk of electric shock, do not immerse this appliance in water or other liquids.
12. To reduce the risk of electric shock, do not disassemble this appliance, but take it to a qualified technician when service or repair work is required. Incorrect reassembly can cause electric shock when the appliance is subsequently used.
13. The use of an accessory attachment not recommended by the manufacturer may cause a risk of fire, electric shock, or injury to persons.
14. Connect this appliance to a grounded outlet.
-  15. This unit is equipped with optical lenses and should not be exposed to direct sunlight.
16. Keep ventilation openings free of any obstructions.
17. Always remove the lens cap when the projection lamp is on.

SAVE THESE INSTRUCTIONS

The information contained in this manual will help you operate and maintain your 3M™ Multimedia Projector MP8030 machine.



1-1. Contents of Shipping Box

The 3M™ Multimedia Projector MP8030 is shipped with the necessary cables required for standard VCR, PC, MAC™ II or laptop computer connections. Carefully unpack and verify that you have all of the items shown below in Figure 1-1. If any of these items are missing, please contact your place of purchase.

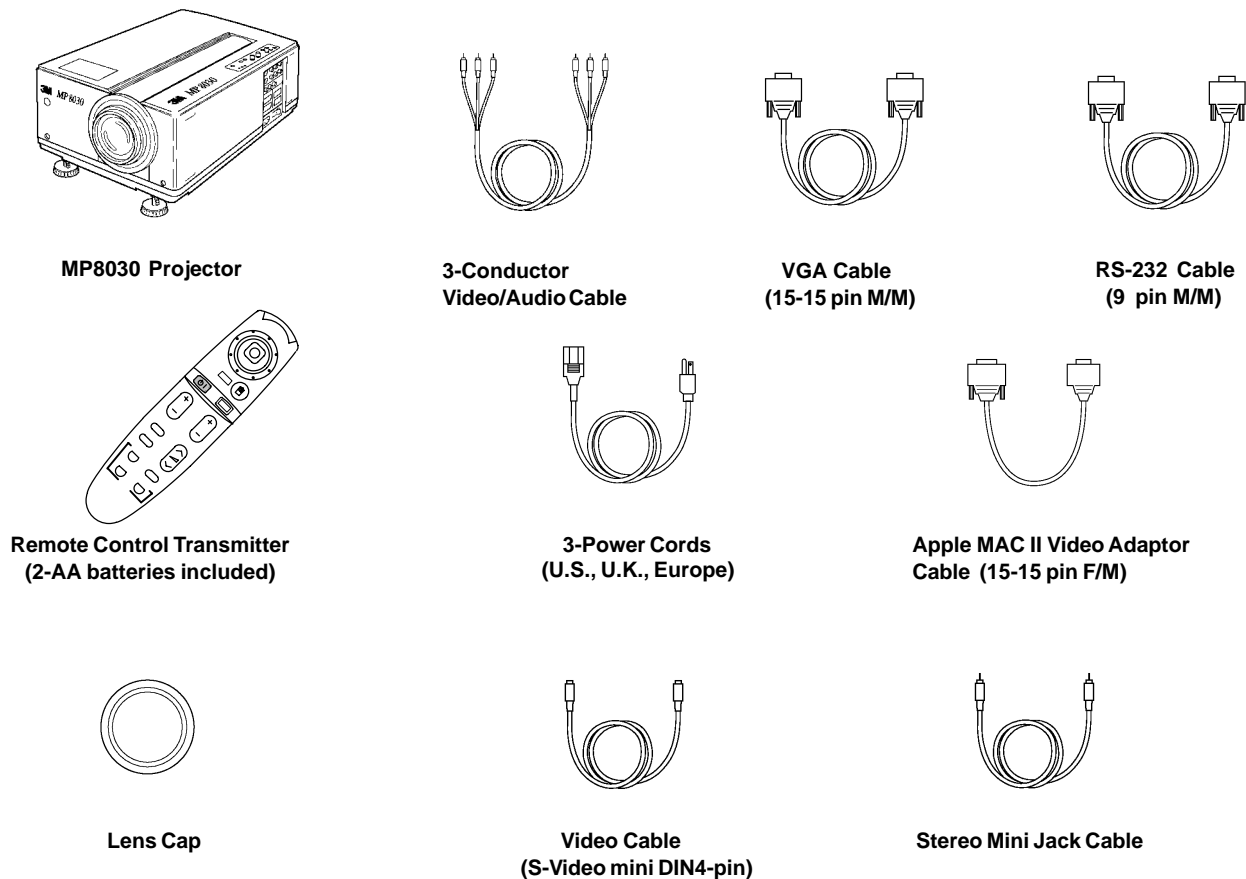

Figure 1-1. Inventory of Shipping Box

1-2. Keep Your Packing Materials

Save the shipping box and packing materials in the event the MP8030 should require shipping to a 3M Service Center for repair.

1-3. What's Next?

After you have unpacked the MP8030 system and identified all the parts, you are ready to set up the projector.

Take a few minutes to review Section 2 to familiarize yourself with the MP8030 machine characteristics and then turn to Section 3 to set up the projector.



Section 2: Product Description

2-1. Machine Characteristics

The 3M™ Multimedia Projector MP8030 integrates metal halide lamp and polysilicon display technology into a single unit. It accepts input from two different computer sources and two video/audio sources and projects a bright super crisp image. Switching your presentation from a computer to a video image back to a computer simply requires the push of a button on the remote control keypad or control panel keypad.

The MP8030 Multimedia Projector offers the following features:

- Easy to set up and use
- Portable (suitcase-style carrying handle)
- Metal halide projection lamp
- 500 lumens lamp output
- 640 x 480 VGA image (NTSC, PAL, SECAM)
- Ability to display 16.7 million colors
- Two computer input connections
- Two video input connections
- Power zoom and focus
- Full function remote control (mouse emulation via serial port)
- Lighted control panel keypad (push button back-lit remote control keypad)
- Built-in speaker (3 Watts)
- Horizontal and vertical image inverting function allows rear projection or ceiling mount
- Horizontal and vertical image position control
- On-screen menu displays in your choice of seven different languages
- On-screen menu to adjust video image: tint, brightness, color, contrast, sharpness, video system, screen blank color, timer, reveal rate and menu size
- On-screen menu to adjust computer video (RGB) synchronization, image brightness, sharpness, horizontal phase and horizontal size
- Automatic keystone correction
- Universal power supply

2-2. Parts Identification List

The numbers shown below correspond to the names of the projector parts in Figure 2-1.

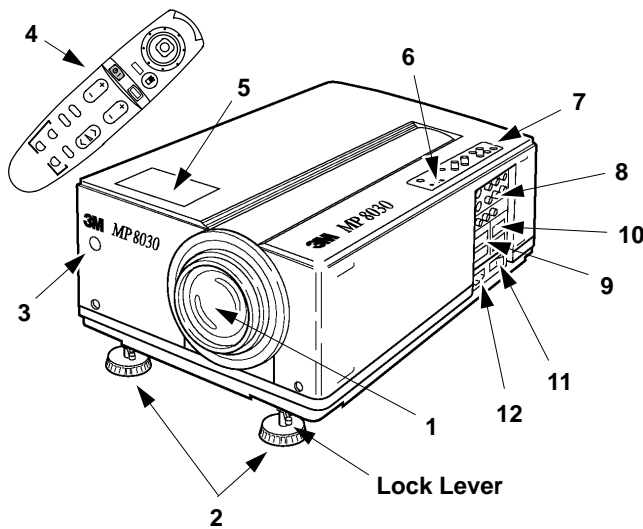

1. Lens
2. Height Adjustment Feet (with lock lever)
3. Remote Control Sensor
4. Remote Control Transmitter
5. Built-In Speaker
6. Indicator Lights (On, Lamp, Temp)
7. Control Panel Keypad
 - a. Standby/On button
 - b. Input Button
 - c. Mute Button
 - d. Zoom Button
 - e. Focus Button
 - f. Menu Button
 - g. Reset Button
8. Video/Audio Input Terminals
 - a. S-Video1/S-Video2 (Mini DIN4-pin)
 - b. Video1/Video2 (RCA Jack)
 - c. Audio-L/Audio-R (RCA Jack)
9. Computer Video (RGB) Input Terminals
 - a. RGB1/RGB2 (D sub 15-pin)
 - b. Audio-L/Audio-R (Stereo Mini-Jack)
10. Output Terminals
 - a. RGB (D sub 15-pin) CRT Display
 - b. RS-232 (D sub 9-pin) Mouse Control
 - c. Audio (RGB/Video) Stereo Output
11. Power Switch
12. Power Cord Connector

Figure 2-1. Identifying MP8030 Projector Parts



3-1. Cable Connections

It only takes a few minutes to connect the 3M™ Multimedia Projector MP8030 to your computer, VCR or other video device (Figure 3-1).

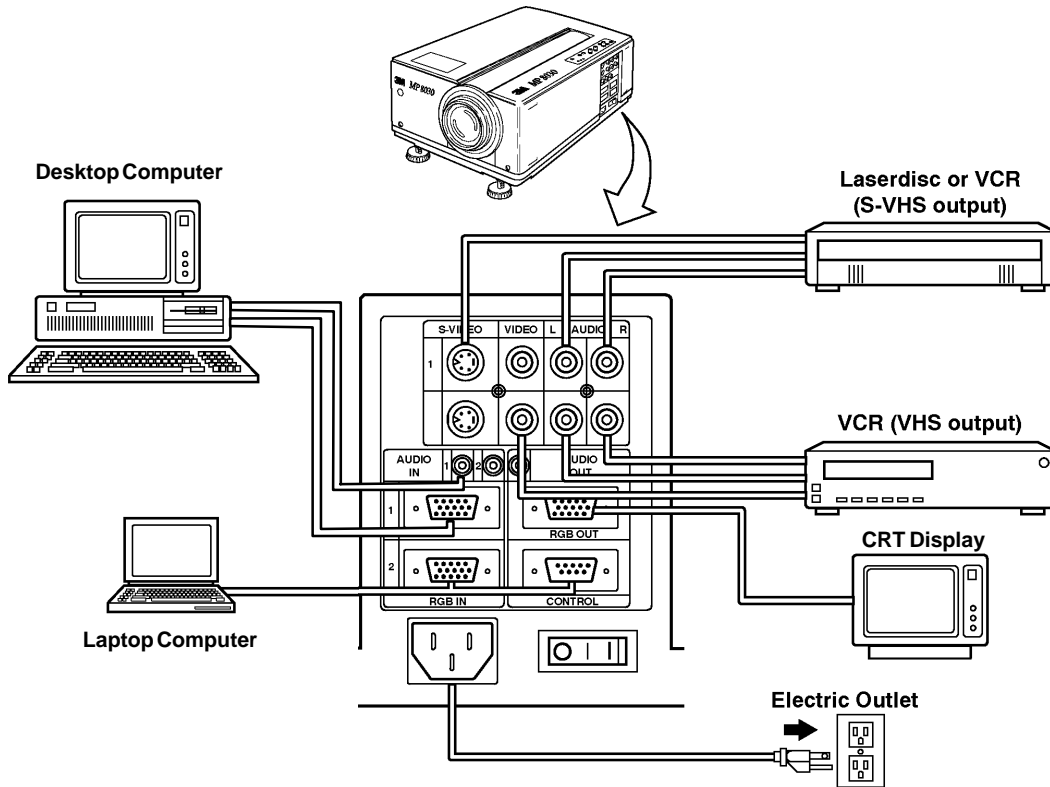

Figure 3-1. Typical Cable Configuration

Terminal Connection Panel

Take a moment to look over the input connection terminals (Figure 3-2) on the side of the projector. Connect your first input source to the *Terminal 1* connectors and your second input source to the *Terminal 2* connectors.

Terminal connectors for VIDEO/AUDIO 1&2 are: S-Video, Video, Audio-L and Audio-R.

Terminal connectors for Computer1 (RGB1) are: RGB-In and Audio-In 1.

Terminal connectors for Computer2 (RGB2) are: RGB-In, Audio-In 2 and Control.

Terminal connectors for output are: RGB-Out (CRT), Audio-Out (stereo) and RS-232 (mouse control).

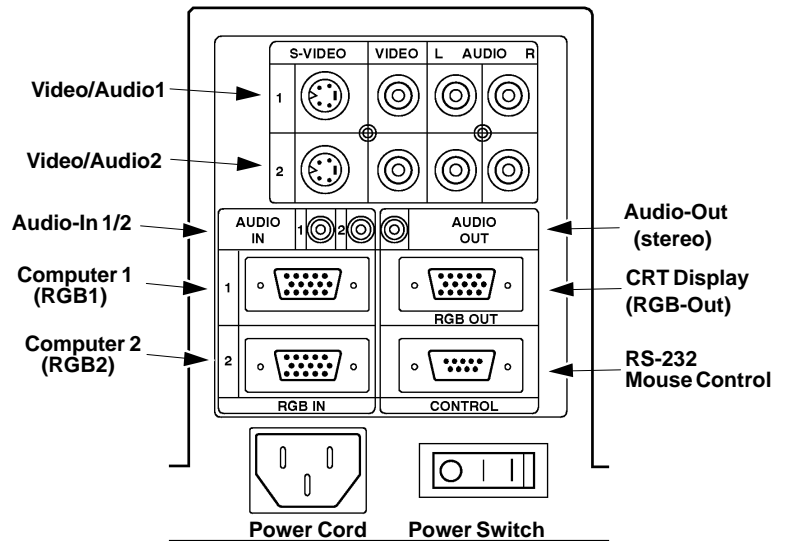

Figure 3-2. Input Connection Terminals

Power Connection

Caution

To prevent damage to equipment, all power to the 3M™ Multimedia Projector MP8030 and input sources must be turned OFF during cable hook up.

The power cord (Figure 3-3) is detachable from the projector and has different connection plugs on each end. Plug the female end into the power cord terminal on the projector and the male end into a properly grounded electrical outlet.

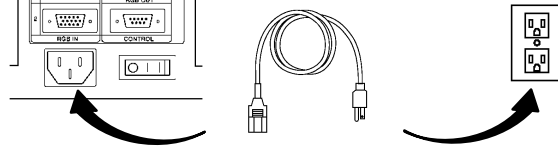

Figure 3-3. Connecting the Power Cord

Computer (RGB) Connection

There are two input jacks and one output jack available for connecting either desktop or laptop computers. Find the cable that fits your computer type. The MP8030 comes with two computer input cables. The first cable (Figure 3-4) fits IBM® PC and compatible VGA video systems, and the other cable (Figure 3-5) fits on the end of the first cable and adapts it to fit Apple MAC™II computers and Apple MAC Powerbook laptop computers. Connect the CRT cable into the RGB-Out terminal to view the image on both the monitor and MP8030.

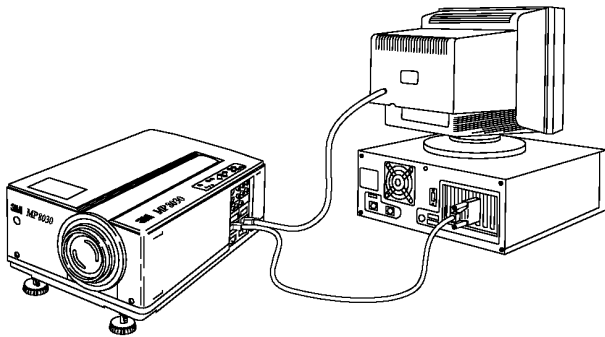

Figure 3-4. IBM® PC Computer

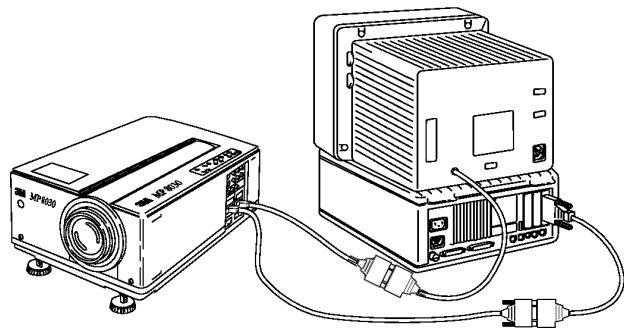

Figure 3-5. Apple MAC™ II Computer

S-Video Connection

Some video devices can generate S-VHS video, or S-Video (Y/C). The MP8030 will accept this signal through the S-VIDEO1 or S-VIDEO2 connectors. The S-VHS cable has identical round four-pin connectors on either end (Figure 3-6). Connect one end to the S-Video jack on the input source device, and the other end to the S-VIDEO1 or S-VIDEO2 terminal on the MP8030. Remember to connect the audio cables for sound output.

Four-Pin Connector



S-VHS Cable

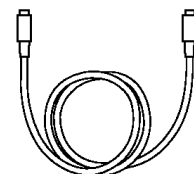

Figure 3-6. S-Video Input

Video/Audio Connection

Find the small, circular connector on your camcorder laserdisc player, VCR, or other video source marked VIDEO OUT, TO MONITOR, or something similar.

Use the 3-conductor video/audio cable and insert the video (white) connector into the video output jack of your video source device, and the other end into the MP8030's VIDEO1 or VIDEO2 connector.

Next, find the AUDIO OUT terminals on your VCR or other audio source. Insert the left and right audio cable connectors (Figure 3-7) to the input source, and connect the other end to the AUDIO-L and AUDIO-R terminals on the MP8030.

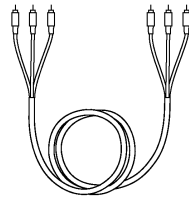

Figure 3-7. 3-Conductor Video/Audio Input Cable

Use the Audio-Out terminal to disable the MP8030 speaker and channel sound to external speakers. The remote control VOLUME and MUTE buttons will control the external speaker volume levels. If you are giving a multimedia presentation that is complete with stereophonic sound, then you may want to consider connecting your audio source to a high-quality stereo system. Of course, if you route your audio cables this way, the MP8030 audio controls (VOLUME and MUTE) will not function.

RS-232 Mouse Control Connection (IBM Compatibles)

The MP8030 projector has an RS-232 connector (Figure 3-8) that allows IBM compatible serial mouse emulation.

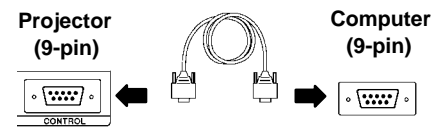

Figure 3-8. RS-232 Terminal

To emulate a serial mouse:

- Power on the M3 and C computer
- Connect the RS-232 cable to the PC mouse serial port and MP8030 Control connector
- Power up the MP8030
- Power up the PC
- If the PC has an internal pointing device, it must be disabled (refer to your owners manual for instructions)
- After the pointing device is disabled, reboot the PC and the operating system (DOS®, Windows™) should recognize the MP8030 stick switch as the pointing device

3-2. Projector SetUp

The meeting room is your operating environment and any stray light hitting the projection screen will become glare. It is best to use a meeting room without wide-open windows. If there are “light stripes” from venetian blinds, try to find a viewing area that’s away from them—and remember, the light stripes will move as the hour changes.

Note

Whenever you have a choice, light the room from the rear, away from the projection screen. The MP8030 has a brightness adjustment to achieve the best image possible.

Distance to Viewing Screen

The 3M™Multimedia Projector MP8030 can be used in a small or large meeting room to project a quality image from 46 cm (18 in.) to 762 cm (300 in.) in size. The distance between the projector and the viewing screen (see “a” in Figure 3-10) and the zoom lens setting (minimum to maximum) will determine the size of the projected image. Refer to the table in Section 9-2 to determine how far away from the viewing screen you need to place the projector to fill the screen with the projected image.

Remember that increasing the projector-to-screen distance also decreases the image’s brightness dramatically. In other words, as the image grows larger, it also grows dimmer. For best results, experiment to find the right combination of projector-to-screen distance and room lighting.

Projector-to-Viewing Screen Alignment

The size of the projection screen and the distance of the projector to the screen are important considerations for determining the best placement of the projector. After the best projector-to-screen distance has been determined, the position of the projection screen in relation to the center of the projection lens must be considered.

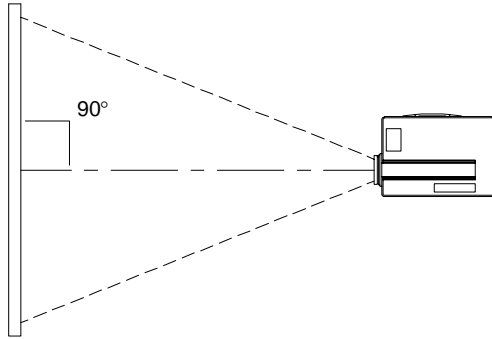

Figure 3-9. Top View

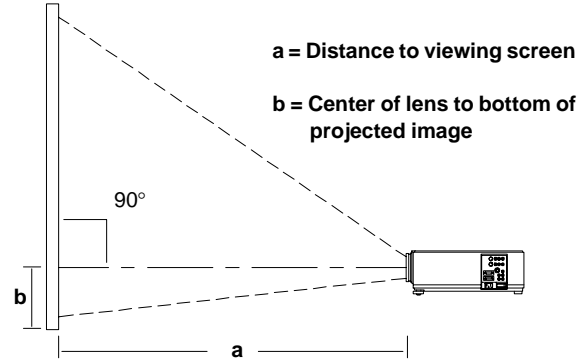

Figure 3-10. Side View

Measured from the center of the projection lens (Figure 3-9), the projected image should be split equally left to right. For best results, rotate the projector until the image on the projection screen is perpendicular (90°) to the lens.

Measured from the center of the projection lens, the top to bottom projected image (Figure 3-10) is projected with most of the image above the center of the lens and a small amount below the center of the lens. The position of the projected image to the center of the lens is an important consideration for the vertical placement of the projection screen.

Use the table below to calculate the approximate distance (see “*b*” in Figure 3-10) from the center of the lens to the bottom of the projected image. Both normal and ceiling mount applications are affected by this distance.

Screen	a		b
	Minimum	Maximum	
102 cm (40 in.)	137 cm (53 in.)	223 cm (87 in.)	8 cm (3 in.)
152 cm (59 in.)	209 cm (82 in.)	340 cm (133 in.)	13.2 cm (5 in.)
203 cm (79 in.)	282 cm (110 in.)	455 cm (177 in.)	17.5 cm (7 in.)
254 cm (99 in.)	353 cm (138 in.)	569 cm (222 in.)	22.1 cm (8.6 in.)
305 cm (119 in.)	427 cm (167 in.)	685 cm (267 in.)	26.4 cm (10 in.)
381 cm (149 in.)	533 cm (208 in.)	858 cm (335 in.)	33 cm (13 in.)
508 cm (198 in.)	714 cm (278 in.)	1149 cm (448 in.)	43 cm (17 in.)

Adjusting the Projector Elevation

The elevation of the projected image can be adjusted by pushing the lock lever (Figure 3-11) on each projector leg to the *unlock* position. Raise or lower the projector body to extend or retract the projector leg until the desired elevation (1 to 7°) is obtained. Push the lock lever to the *lock* position to secure each projector leg.

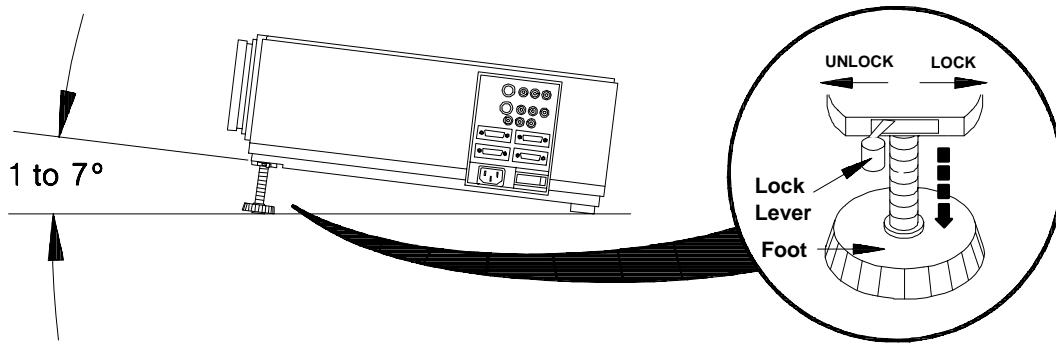

Figure 3-11. Projector Leg Adjustment

Note

Both projector legs must be raised or lowered the same amount to project a level image on the screen. Minor elevation adjustments can be made by turning the foot in a clockwise or counterclockwise direction.

Ceiling Mount Considerations

An optional ceiling mount bracket (Figure 3-12) is required to install the MP8030 from the ceiling. For this type of installation, the image must be inverted. Refer to *Section NO TAG, Inverting the Image* for more details.

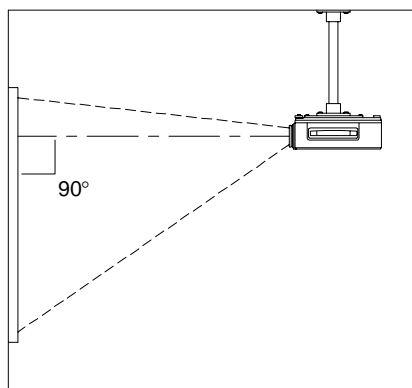

Figure 3-12. Optional Ceiling Bracket

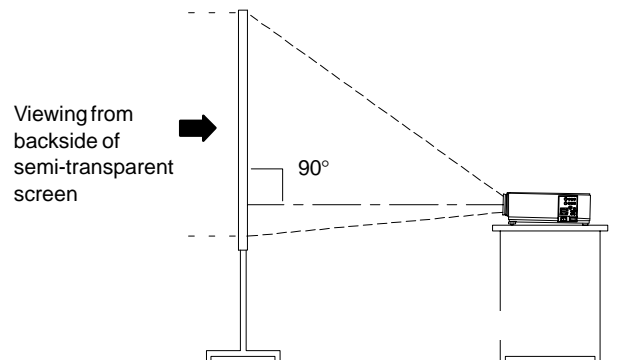

Figure 3-13. Rear Projection Viewing

Rear Projection

A semi-transparent screen (Figure 3-13) can be used to project an image and view it from the backside of the viewing screen. For this type of installation, the image must be inverted. Refer to section *NO TAG Inverting the Image* for more details.

3-3. Now What?

Your MP8030 is now connected and ready to power on. Turn to Section 4 for details on operating the projector.



Section 4: Operating the Projector

4-1. Turning On the Projector

Read the Important Safeguards before operating the 3M™Multimedia Projector MP8030.

Refer to Section 3 to make all cable connections. When the input cables and power cords are connected, turn on the power, adjust the size and focus of the projected image and begin your presentation.

Power On: Turn on the projector power, then turn on the power to your input sources. The projector power switch is located in the lower right corner of the input terminal panel.

Press the power switch to ON to apply power to the projector. | = ON O = OFF

⚠ Caution
Allow a projector that has been stored in a cold place to warm up to operating temperature 0°C to 35°C (32°F to 95°F) before applying power.

The ON indicator on the projector control panel will turn orange, indicating the unit is in the *standby mode*.

Note

The lamp does not energize in the standby mode.

Remove Lens Cap: Remove the lens cap from the projection lens before energizing the lamp.

Projector Control Panel: The projector control panel (Figure 4-1) is located on the top of the projector. Use these buttons to control the projector functions or use the remote control transmitter.

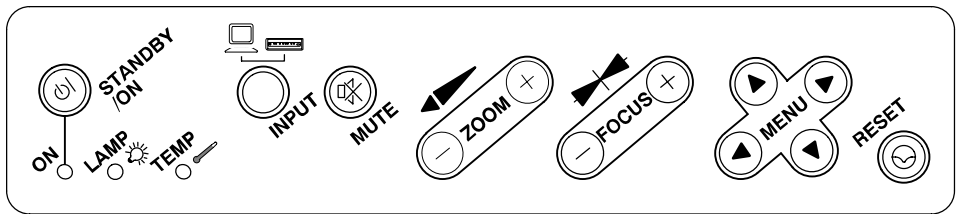



Figure 4-1. Projector Control Panel

Energize Lamp: Press the **STANDBY/ON**  button to energize the lamp. The ON indicator will blink as the metal halide lamp warms up. It takes a few moments for the lamp to reach its full light output. When the lamp is ready, the ON indicator turns solid green.

Select Input: Press the **INPUT**  button to select the desired computer video source or video source. Press the INPUT button again to select the next input source. The input sources are selected in the following sequence:

RGB1 → RGB2 → Video1 → Video2 → RGB1 ... etc.



The following *Error Messages* may display if there is a video input problem:



NO INPUT DETECTED Cables are not connected to input jacks or input source is off.

SYNC IS OUT OF RANGE The connected input source is not compatible with the MP8030.



Mute: Press the MUTE  button to turn off the sound to the speakers. Press again to restore the sound.

Note

The volume level is controlled from the remote control transmitter.

Zoom: Press the ZOOM  button to adjust the image size to fill the screen. Press and hold down  or  until the image is the desired size. If you cannot make the image fill the screen, move the projector further back from the screen.

Focus: Press the FOCUS  button to adjust the sharpness of the image. The following on-screen display will appear:

Press and hold down  or  until the image becomes sharp and clear.

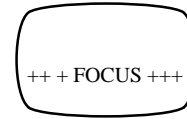

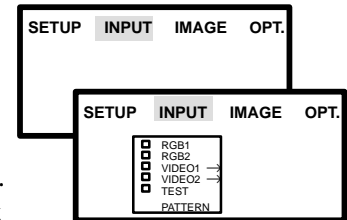

Menu: Press the MENU  button to display the names of the system menus across the top of the projection screen. These menus are used to adjust the characteristics of the projected image. MENU

Press the left/right arrow (← MENU →) to select (highlight) and display each menu. Press the up/down (↑ MENU ↓) arrow or left/right (← MENU →) arrow again to select (highlight) the desired menu option. See Section 4-5 for more about using menus.



Volume Adjustment: Use the VOLUME  button on the remote control to adjust the speaker volume. Press (∧) to increase or (∨) to decrease the volume level. See Section 4-6 to set the volume in the Setup menu.

4-2. Turning Off the Projector



Press and hold down the STANDBY/ON  button for one second to switch the projector to the standby mode. *The one second hold-down period is designed to avoid accidentally turning off the projector if the standby/on button is bumped.* The lamp will shut off and the green indicator on the projector panel will turn to orange. Wait until the cooling fan motor cycles off before you press the Power Off  switch.

Note

Switching the power off before the fan has cycled off, will decrease the life of the projection lamp.

4-3. Memory Function/Factory Defaults

The MP8030 will retain all picture adjustment settings you make until you either change them again or return all settings to the factory default.

To return picture adjustments back to the factory settings, press the RESET button on the projector control panel  or remote control transmitter .

4-4. Adjusting the Picture

The projected image can be adjusted from on-screen menus using either the projector control panel or remote control transmitter buttons.

For *video signals* you can adjust:



- Brightness (dark to light)
- Tint (red to green) *NTSC signals only*
- Color (low to high)
- Contrast (low to high)
- Sharpness (low to high)
- Language (menu display in seven languages)
- Image Inversion (horizontal/vertical)
- Video System (AUTO, NTSC, PAL, SECAM)

For *Computer (RGB) signals* you can adjust:

- Brightness (dark to light)
- Contrast (low to high)
- Horizontal/Vertical Position
- Horizontal Phase (synchronization)
- Horizontal Size (increase/narrow size of image)
- Image Inversion
- Language (menu display in seven languages)

4-5. Using System Menus

You can use either the projector control panel (Figure 4-1) or the remote control transmitter (Figure 5-1) to access menus, exit menus and set menu options.

Press MENU  on the projector panel or  on the remote control to display the names of the system menus across the top of the projection screen (Figure 4-2). To select one of these menus, press the left/right menu arrow (← MENU →) on the projector control panel or move the remote control stick switch  left/right until the desired menu name is highlighted.

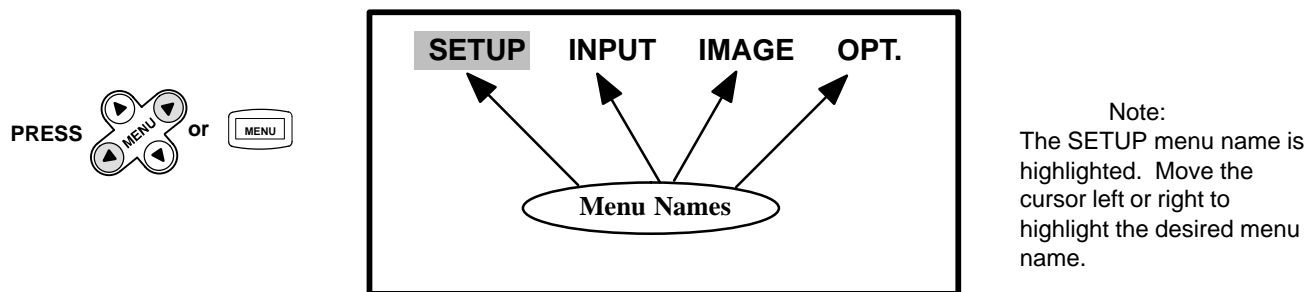

Figure 4-2. System Menu

Highlighting a menu name will display the options for that menu (Figure 4-3).

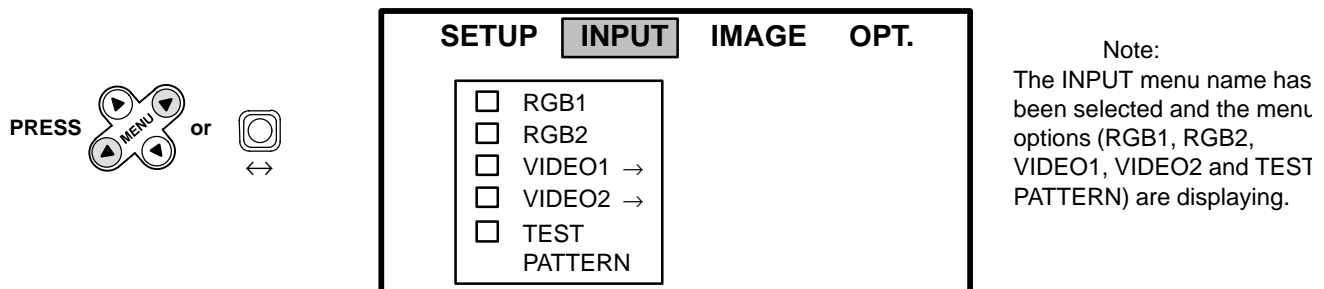



Figure 4-3. Input Menu Options

Press the up/down menu arrow (↑ MENU ↓) or move the remote control stick switch  (up/down) to highlight the desired menu option. Highlighting a menu option will select that line.

Some menu options will have an arrow at the end of the line (VIDEO1, VIDEO2). This arrow indicates that a sub-menu (Figure 4-4) with additional options will display if you select that option.

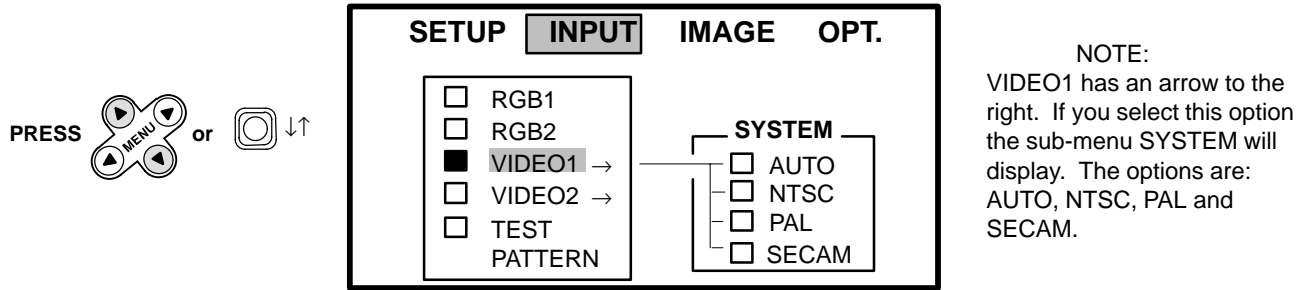

Figure 4-4. Selecting VIDEO1

Press the up/down menu arrow (↑ MENU ↓) or move the remote control stick switch (stick with up/down arrows) (up/down) to highlight the desired sub-menu option.

To exit a menu and return to the video/RGB image, press the 'MENU' button or the remote control stick switch (stick with left/right arrows). You have 10 seconds to make a menu selection and then the projector will automatically return to the video or RGB image.

4-6. Setup Menu (RGB and Video Picture)

Press the left/right menu arrow (← MENU →) or move the stick switch (stick with left/right arrows) left/right to select the SETUP menu. Depending on the current input source either the RGB menu or Video menu will display.

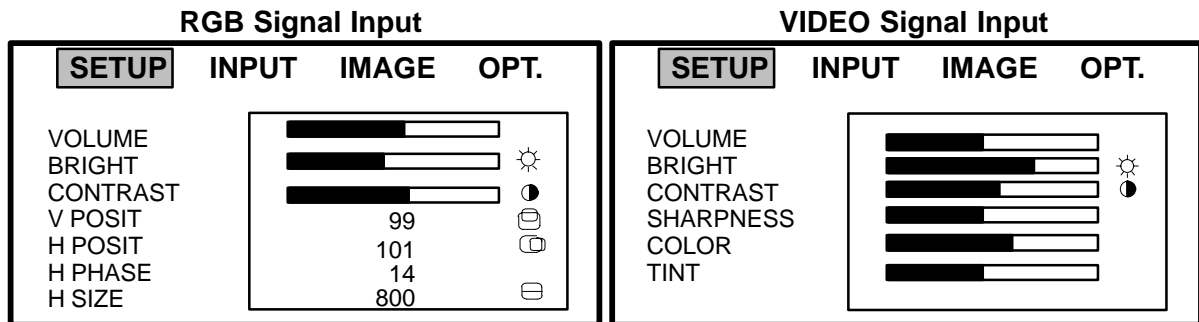

Select this option:	To adjust the following:
VOLUME	Set speaker/Audio-Out volume (low to high)
BRIGHT	Set picture brightness (dark to bright)
CONTRAST	Set picture contrast (low to high)
SHARPNESS (video only)	Set sharpness of video signal (soft to sharp)
COLOR (video only)	Set amount of picture color (less to more)
TINT (video, except PAL video)	Set video picture tint (red to green)
V.POSIT (RGB only)	Move the picture image up or down
H.POSIT (RGB only)	Move the picture image left or right
H.PHASE (RGB only)	Decrease the picture flicker
H.SIZE (RGB only)	Set size of horizontal picture (narrow or widen)

4-7. Input Menu

4-7-1. Selecting the Input Source

The input source is selected from the Input menu. The 3M™ Multimedia Projector MP8030 has an automatic video selection function that will choose the correct video system or you can manually select the video system.

Press the left/right menu arrow (← MENU →) or move the stick switch  left/right to select the INPUT menu and the VIDEO1/2 SYSTEM sub-menu. If you select an input source that is not connected, the start-up screen with an error message will display. Press the menu button to remove the menu display.

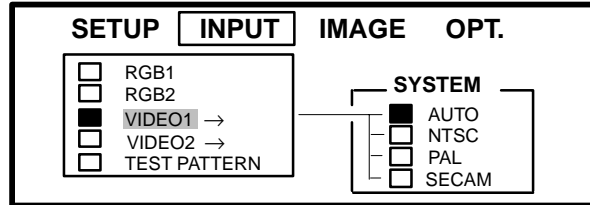

Select this option:	To select:
RGB1	Computer 1 (RGB) terminal
RGB2	Computer 2 (RGB) terminal
VIDEO1	Video1 terminal (AUTO, NTSC, PAL, SECAM)
VIDEO2	Video2 terminal (AUTO, NTSC, PAL, SECAM)
TEST PATTERN	Display the test pattern start up screen

4-8. Image Menu

4-8-1. Inverting the Image

The image can be inverted for ceiling mounted or rear projection applications. Press the left/right menu arrow (← MENU →) or move the stick switch  left/right to select the IMAGE menu and the MIRROR sub-menu.

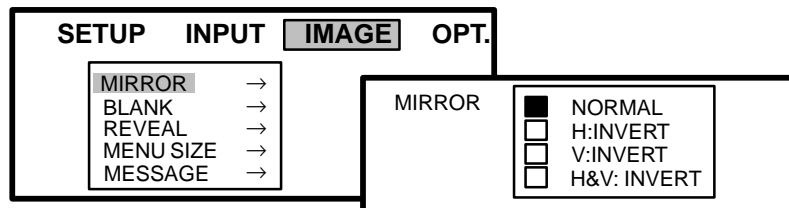

Select this option:	To adjust the following:
H:INVERT	Invert the image horizontally
V:INVERT	Invert the image vertically
H&V:INVERT	Invert the image both horizontally and vertically

4-8-2. Changing the Screen Background Color (Blank Button)

The background color of the system menus can be white, blue or black. Press the left/right menu arrow (← MENU →) or move the stick switch  left/right to select the IMAGE menu and the BLANK sub-menu.

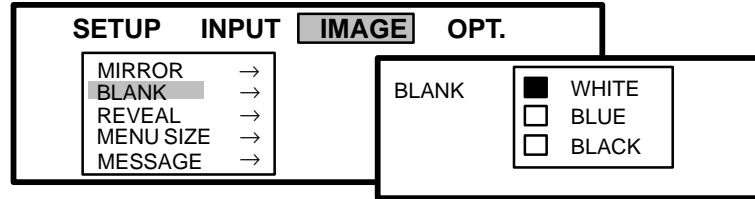

Select this option:	To adjust the following:
WHITE	Make screen backgrounds white
BLUE	Make screen backgrounds blue
BLACK	Make screen backgrounds black

4-8-3. Changing the Screen Reveal Rate

The rate at which a blank screen will display (reveal) data from top to bottom can be set to slow, medium or fast. Press the left/right menu arrow (← MENU →) or move the stick switch  left/right to select the IMAGE menu then select the REVEAL sub-menu. See *Stick Switch* and *Blank* button descriptions in *Section 5-1*.

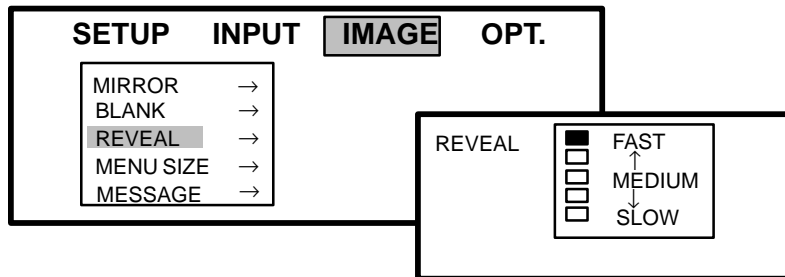

Select this option:	To adjust the following:
FAST	Blank screen will reveal at a fast rate
MEDIUM	Blank screen will reveal at a medium rate
SLOW (default)	Blank screen will reveal at a slow rate

4-8-4. Changing the Menu Size

The size of the menu can be either small or large to fill the entire screen. Press the left/right menu arrow (← MENU →) or move the stick switch  left/right to select the IMAGE menu and the MENU SIZE sub-menu.

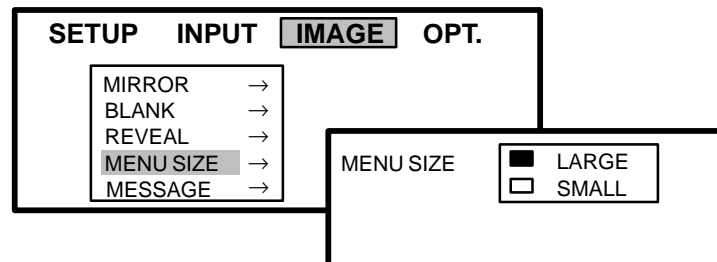

Select this option:	To adjust the following:
LARGE	Size the menu to fill the projection screen
SMALL	Size the menu to fit in the lower right corner of screen

4-8-5. Display Startup Screen/Error Message

If no input is detected when switching to an RGB or video source, either the startup screen and error message “NO INPUT DETECTED” or a blank screen with no error message will display. Press the left/right menu arrow (← MENU →) or move the stick switch  left/right to select the IMAGE menu and the MESSAGE sub-menu.

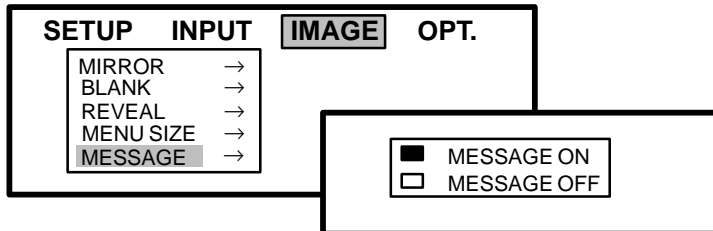

Select this option:	To display:
MESSAGE ON	Startup screen and error message display if no input is detected
MESSAGE OFF	Blank screen, no message, no startup screen if no input detected

4-9. Options (OPT.) Menu

4-9-1. Communication Speed

The data speed of transmission (bPS) can be set for the computer mouse control. Press the left/right menu arrow (← MENU →) or move the stick switch  left/right to select the SETUP menu and the COM. SPEED sub-menu. *The computer mouse for most IBM compatible computers will operate at a baud rate of 1200.*

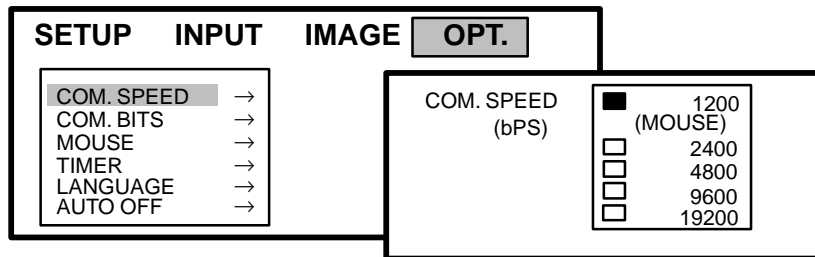

Select this option:	To adjust the following:
Communication Speed (bPS)	Data speed of transmission: 1200 (mouse), 2400, 4800, 9600, 19200

4-9-2. Communication Bits

The data format of transmission is set with this option. Press the left/right menu arrow (← MENU →) or move the stick switch  left/right to select the OPT. menu and the COM. BITS sub-menu. *The computer mouse for most IBM compatible computers will operate at a speed of 7N1.*

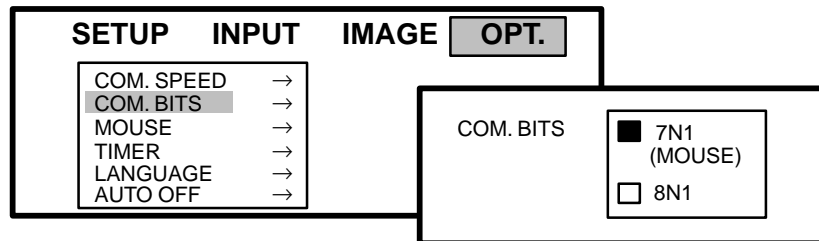

Select this option:	To adjust the following:
Com. Bits: Speed of mouse movement	7N1 (mouse) . . . 7 data-bits, no parity, 1 stop bit 8N1 8 data-bits, no parity, 1 stop bit

4-9-3. Mouse Speed

Press the left/right menu arrow (← MENU →) or move the stick switch  left/right to select the OPT. menu and the MOUSE sub-menu.

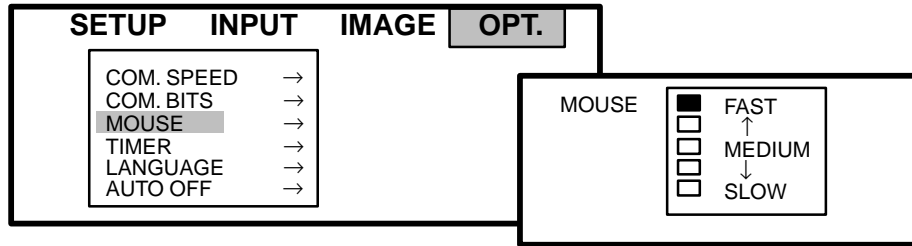

Select this option:	To adjust the following:
Mouse Speed	Mouse speed of movement (slow, medium, fast)

4-9-4. Set Countdown Timer

Press the left/right menu arrow (← MENU →) or move the stick switch  left/right to select the OPT. menu and the TIMER sub-menu. Once the minutes for countdown timer are set, press the TIMER button on the remote control to start/stop the timer. See remote control.

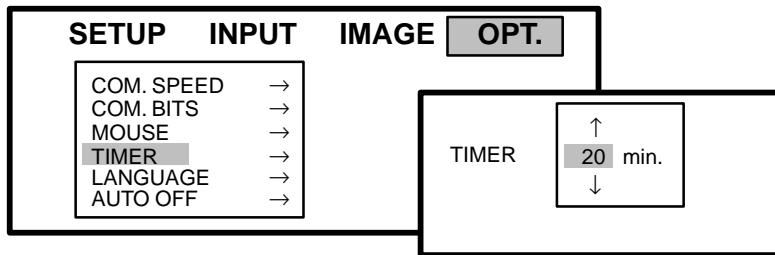

Select this option:	To adjust the following:
Timer	Minutes (up to 99) for the on-screen countdown timer

4-9-5. Language

Press the left/right menu arrow (← MENU →) or move the stick switch  left/right to select the OPT. menu and the LANGUAGE sub-menu. Select the desired language and exit the menu to initiate the change.

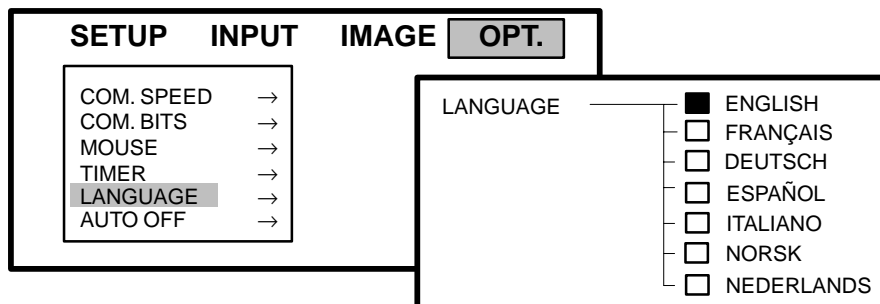

Select this option:	To adjust the following:
Language	On-screen menus/messages will display in this language

4-9-6. Auto Power Off

This function can be set to automatically switch the projector to standby mode if no input is detected within a set period of time. Press the left/right menu arrow (← MENU →) or move the stick switch (⊙) left/right to select the OPT. menu and the AUTO OFF sub-menu. To disable function, set the wait period to 0.

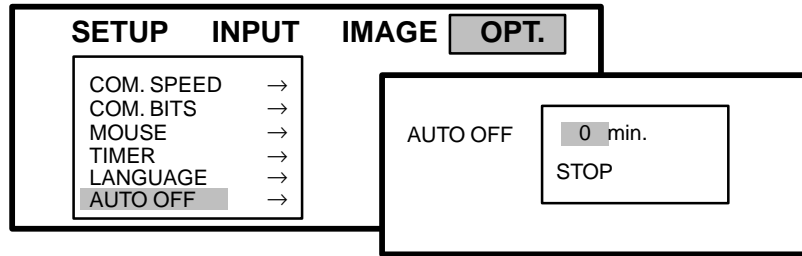

Select this option:	To adjust the following:
Automatic Off	Wait period from 1 to 99 minutes before projector will switch to standby mode if no input is detected



5-1. How to Operate the Remote Control

The remote control keypad (Figure 5-1) has the same buttons as the projector control panel, plus additional buttons to control different projector functions. To use the remote control, aim the remote toward the projection screen and press the desired button. The remote signal will bounce off of the projection screen and back to the sensor on the front of the 3M Multimedia Projector MP8030.

Remote Control Buttons



Stick Switch: Move the menu stick switch up/down or left/right for mouse (cursor control) functions. If a menu is displaying, use the stick switch to move around within the menu to select options. See the MENU  button.



Reset: Press RESET, to return all menu options or select (highlight) an individual menu option, to return a single menu option to the factory defaults. When an RGB image is displaying, press RESET for the right mouse button function.



Standby/on: Press and hold (one second) to switch between projection and standby mode. The projection lamp is off in standby mode.



Menu: Press the menu button to display the main menu. Move the menu stick switch left or right as needed to select a menu. Press the menu button again to remove the menu and return to the video image.



Zoom: Sizes the picture to fit the screen. Press (+) to make the projected image wider or (-) to reduce the image size.



Focus: Press (+) or (-) to focus the image.



Timer: Press the timer button to display the timer and start the countdown. Press the timer button again to stop the timer, reset it to the full countdown time and return to the video image. The countdown timer can be set for up to 99 minutes. See the OPT. menu.



Blank: Press the blank button to remove (blank) the video image from the screen. Press blank or pull the stick switch downward to reveal the screen image. See the IMAGE menu *Section NO TAG* to set the screen background color and the screen reveal rate.



Volume: Press (∧) to increase or (∨) to decrease the speaker volume or external speaker(s) connected to the Audio-Out terminal.



Mute: Turn the audio (speaker) sound ON (volume bar turns green) or OFF (volume bar turns red).



Search: Press the search button to display the next detachable input source.



Video Input: Selects the desired video input source. Press VIDEO for video source 1, press again for video source 2.



RGB Input: Selects the desired computer video input source. Press RGB for computer video source 1, press again for computer video source 2.

Replacing the Batteries: The remote control uses two AA batteries. Slide open the battery cover on the back of the remote control to access the batteries. Insert the batteries with the correct polarity (NO TAG).

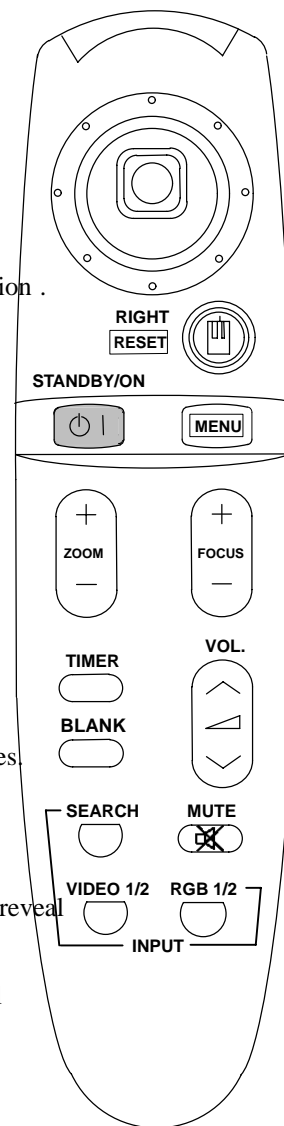

Figure 5-1. Remote Control

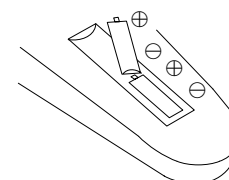



Figure 5-2. Backside of Remote



Section 6: Lamp Replacement

6-1. Metal Halide Projector Lamp

If the projected image appears dark or the LAMP indicator light comes on, the lamp may be getting old and in need of replacement. Press and hold the **TIMER**  button for two seconds to display the number of operating hours for the current projector lamp. Under normal operating conditions, the lamp should last approximately 2000 hours. After that time, the lamp will slowly grow dimmer.

For best results, replace the lamp after 2000 hours of usage.

Note

The LAMP indicator will come on if the lamp becomes too hot. If this happens, wait for the fan motor to stop running, turn the power off and let the projector cool. Check for airflow blockage, clean the air filter then turn the power on. If the LAMP indicator comes on again, call customer service or your dealer.

6-2. Replacing the Lamp

To replace the lamp, the following is needed:

- Phillips screwdriver
- Standard #2 screwdriver
- Metal halide lamp

Important

Always use lamp type: 260W Metal Halide, 70 VDC, 4.3A, Part Number 78-6969-8262-4.

Power OFF: Press the Standby/ON  button on the projector control panel or remote control and wait for the fan motor to cycle off. Then, turn off the power switch and unplug the power cord.

⚠ WARNING

There are high voltage parts inside the cabinet that may cause an electric shock. Always unplug projector when changing the lamp.

⚠ WARNING

Lamp and adjacent metal parts become extremely hot and can cause severe burns to your fingers. Allow the projector to cool for at least 1 hour before replacing the lamp.

Remove Lamp Access Door: The lamp access door is located on the back of the machine on the right side (Figure 6-1). Use a phillips screwdriver to unscrew the lamp cover retaining screw and gently open the cover and set it aside.

Note

The screw is a self-containing screw that cannot be removed from the cover.

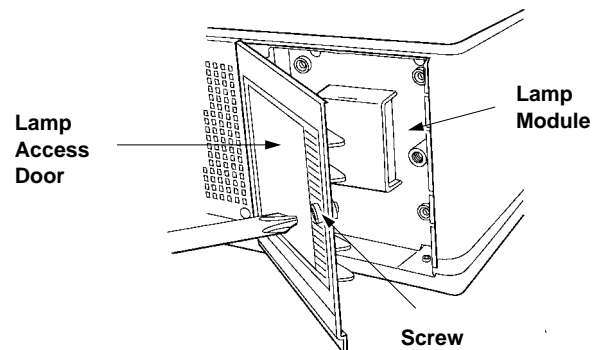

Figure 6-1. Lamp Access Door

Retaining Screws: Use a standard screwdriver to unscrew the lamp module retaining screws (Figure 6-2).

Note

There are four lamp module screws that must be loosened. These screws are self-containing screws that cannot be removed from the lamp module.

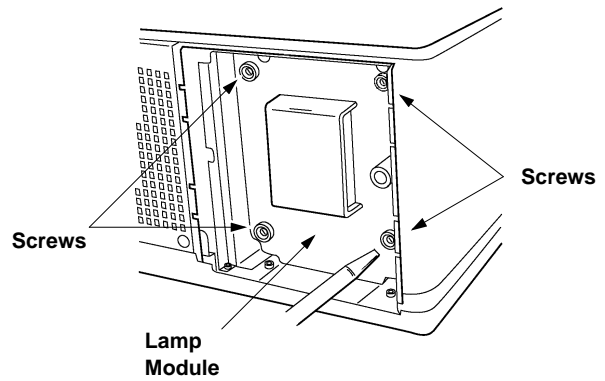

Figure 6-2. Lamp Module Retaining Screws

Remove Lamp Module: Grasp the lamp module with one hand and the projector body opening with the other hand (Figure 6-3). Apply upward pressure to the projector body as you slide the lamp out.

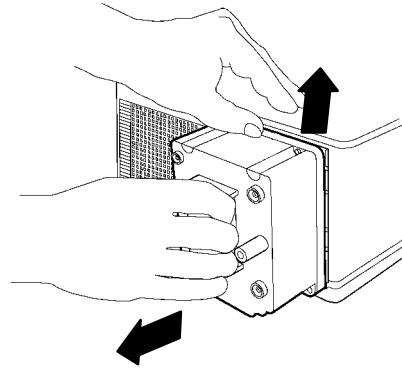

Figure 6-3. Slide Lamp Out to Remove

Insert Lamp Module: Carefully insert the new lamp module into the opening and slide it all the way back into place (Figure 6-5). Check the lamp module to be sure that it is fully inserted and flush against the back wall.

Tighten the lamp module retaining screws to secure the lamp module in place (Figure 6-2).

Insert the hinge tabs on the left side of the lamp access door, then close and tighten the retaining screw to secure the door (Figure 6-1).

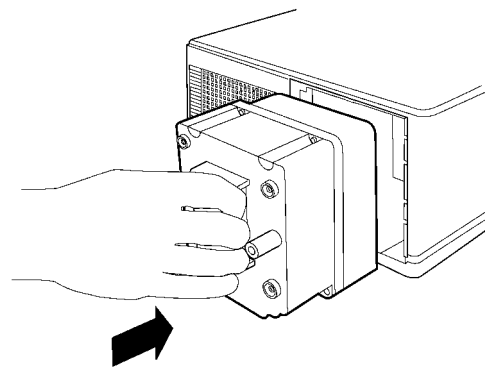





Figure 6-5. Slide Lamp In to Insert

Reset the Operating Hours: Press and hold down the **TIMER**  button for two seconds to display the lamp operating hours. Press the **RESET**  button to display the reset sub-menu (Figure 6-4). Move the stick switch  left/right to select either the **0** field to reset the hours or the **Cancel** field to exit the menu and not change the counter.

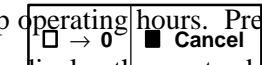

Figure 6-4. Reset Hours

For best results, lamps should be replaced after 2000 hours.



Section 7: Maintenance

7-1. Cleaning

For best performance, keep your projector free of excess dust and surface dirt.

Daily Cleaning

Use a soft cloth to remove dust from the projector housing.

Cleaning the Projection Lens

Use 3M™ Overhead Cleaner 676 to remove surface dirt and smudges from the projection lens (Figure 7-1).

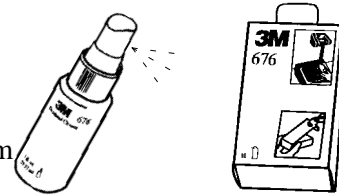

Figure 7-1. Cleaning the Lens

Cleaning the Air Filter

For best performance, clean the air filter every 10 hours of operations. Unplug the power cord and stand the projector upright with the bottom facing you.

Unscrew two retaining screws and pull down and out on the handle to free the air cleaner door (Figure 7-2).

Carefully pry out tabs and lift up on the retaining frame to free the air cleaner (Figure 7-3).

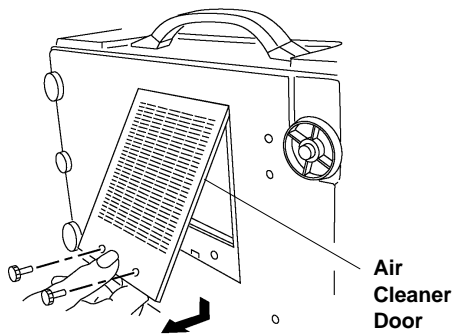

Figure 7-2. Pull Down and Out to Remove Door

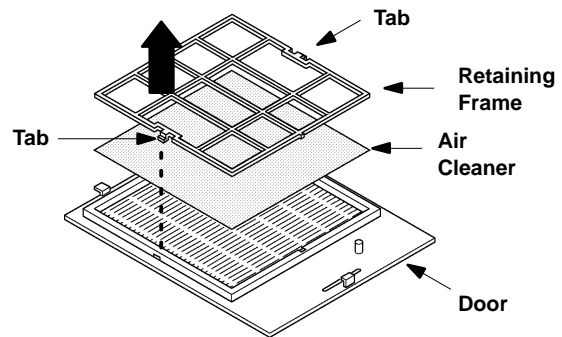

Figure 7-3. Remove Retaining Frame

Use a vacuum cleaner to remove the dust and dirt from the air cleaner screen (Figure 7-4).

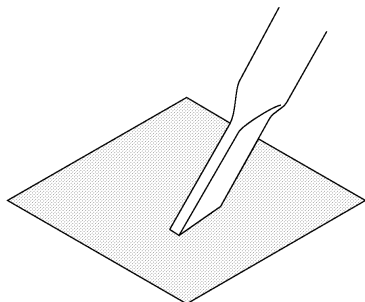

Figure 7-4. Vacuum Air Cleaner Filter

Caution

To avoid damaging the internal projector components, do NOT vacuum the inside of the projector.

Insert the air cleaner in the door (Figure 7-5), position the retaining frame over the air cleaner and push the tabs down into the tab slots to hold the air cleaner and frame to the door.

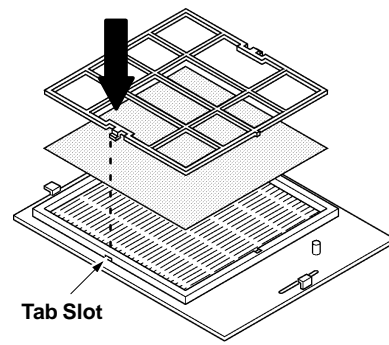

Figure 7-5. Insert Frame and Air Cleaner

Insert the hinge tabs on the door into the slots in the projector body and swing the door down. Push on the handle to fully engage the door latch and then tighten the retaining screws to secure the door. (Figure 7-6).

Note

The air cleaner door must be closed and latched or power to the lamp will be shut off and the LAMP indicator will come on.

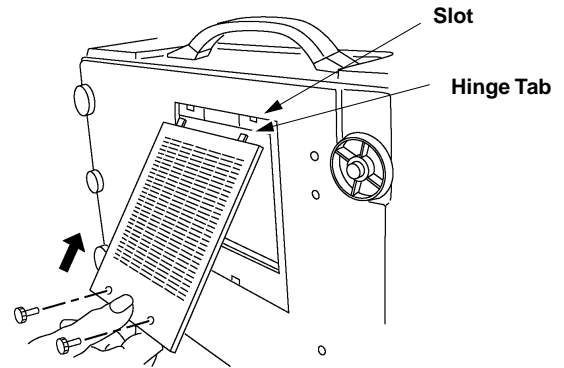

Figure 7-6. Insert Door and Close Tightly



Section 8: Troubleshooting

The 3M™ Multimedia Projector MP8030 has been designed to be as simple and trouble-free to use as possible. If you should run into problems operating the projector, please review the troubleshooting information below.

<u>Problem</u>	<u>Possible Solutions</u>
<i>Power does not come on</i>	<ul style="list-style-type: none">● Power cord must be plugged into an electric outlet.● Power switch must be turned on.
<i>No picture and sound</i>	<ul style="list-style-type: none">● Set the projector to the correct input source.● Check all cable connections from input source to projector.● Make sure the input source power is on.
<i>Picture displays but no sound</i>	<ul style="list-style-type: none">● Check all cable connections from input source to projector.● Press VOLUME/UP on the remote control.● Press the MUTE button.
<i>Sound but no picture</i>	<ul style="list-style-type: none">● Check all cable connections from input source to projector.● Adjust the picture brightness. Press MENU and select SETUP.
<i>Weak color, incorrect tint</i>	<ul style="list-style-type: none">● Adjust the picture color and tint (video only). Press MENU and select SETUP.
<i>Picture is dark</i>	<ul style="list-style-type: none">● Adjust the picture brightness and contrast. Press MENU and select SETUP.● Lamp may need replacement. Call customer service for assistance. See Service Information below.
<i>Picture is not sharp and clear</i>	<ul style="list-style-type: none">● Press FOCUS (+) or (-) buttons. Adjust the sharpness (video only). Press MENU and select SETUP.
<i>LAMP indicator is solid red</i>	<ul style="list-style-type: none">● Turn the power off and let the projector cool. After 20 minutes, turn the power on. If the LAMP indicator comes on again there may be a problem with the lamp. Call customer service for assistance. See Service Information below.
<i>LAMP indicator is blinking red</i>	<ul style="list-style-type: none">● Check the air cleaner to make sure it is fully closed and latched.
<i>TEMP indicator is red</i>	<ul style="list-style-type: none">● Turn the projector off and let it cool. Check the ventilation holes for blockage.
<i>Remote control does not operate</i>	<ul style="list-style-type: none">● Replace old batteries with fresh AA batteries.● The polarity of the batteries (+/-) must match the decal on the remote control.● Point the remote control toward the projection screen so the signal will bounce back to the projector. Also make sure the remote control sensor on the front of the projector is not blocked from receiving the signal.

8-1. Service Information

For product information, product assistance, service information, or to order accessories, please call:

In U.S. or Canada: **1-800-328-1371**

In other locations, contact your local 3M Sales office.



Section 9: Technical Specifications

9-1. Specifications

Width	32 cm (12.59 in.)
Height	17.5 cm (6.9 in.)
Depth	46.2 cm (18.2 in.)
Weight	10.9 kg (24.3 lbs)
Panel size	3.3 cm (1.3 in.)
Number of pixels per panel	311,696 pixels (H644 X V484), 3 panels = 935,088 total pixels
Zoom lens	F/Number: F/3.0–F/3.8 Focal Length: F=46.5–74.4 mm
Metal halide lamp	260W, 500 lumens*, rated at 2000 hours to half life
Speaker	Max. 3W (monaural)
Power supply	100–120VAC, 50/60Hz, 5A or 220–240VAC, 50/60Hz, 2A
Power consumption	Maximum 350W
Storage temperature range	–20°C to 60°C (–4°F to 140°F)
Operating temperature range	0°C to 35°C (32°F to 95°F)
Input terminals	S-Video: Mini DIN4-pin terminal Video: RCA Jack Audio: RCA Stereo Mini-Jack Computer (RGB): D sub15-pin HD terminal
Output terminals	Computer (RGB): RCA Jack Audio: RCA Stereo Mini-Jack RS-232 (Mouse Control): D sub 9-pin HD terminal
Input signals	S-Video: Luminance 1.0V peak to peak , 75Ω termination Chroma 0.286V peak to peak (burst signal) 75Ω term. Video: 1.0V peak to peak, 75Ω termination Audio: 200mvRMS, across 20kΩ
Output signals	Audio: 200mvRMS, across 20kΩ
Batteries for remote control	Two AA, 1.5 Volt

9-2. Projector-to-Screen Distances

Distance to Screen		223 cm (7.3 ft)	341 cm (11.2 ft)	436 cm (14.9 ft)	570 cm (18.7 ft)	686 cm (22.5 ft)	860 cm (28.2 ft)	1173 cm (38.5 ft)
Screen Diagonal	Min Zoom	102 cm (40 in.)	152 cm (60 in.)	203 cm (80 in.)	254 cm (100 in.)	305 cm (120 in.)	381 cm (150 in.)	508 cm (200 in.)
	Max Zoom	160 cm (63 in.)	244 cm (96 in.)	325 cm (128 in.)	406 cm (160 in.)	490 cm (193 in.)	612 cm (241 in.)	836 cm (329 in.)
Screen Width	Min Zoom	81 cm (32 in.)	122 cm (48 in.)	163 cm (64 in.)	203 cm (80 in.)	244 cm (96 in.)	305 cm (120 in.)	406 cm (160 in.)
	Max Zoom	130 cm (51 in.)	196 cm (77 in.)	259 cm (102 in.)	325 cm (128 in.)	391 cm (154 in.)	490 cm (193 in.)	668 cm (263 in.)
Screen Height	Min Zoom	61 cm (24 in.)	91 cm (36 in.)	122 cm (48 in.)	152 cm (60 in.)	183 cm (72 in.)	229 cm (90 in.)	305 cm (120 in.)
	Max Zoom	97 cm (38 in.)	147 cm (58 in.)	196 cm (77 in.)	244 cm (96 in.)	295 cm (116 in.)	366 cm (144 in.)	500 cm (197 in.)

*Manufacturer’s specification for output is 500 ANSI lumens at maximum setting. Performance of individual units may vary by up to ± 10%.

9-3. Physical Dimensions

The 3M™ Multimedia Projector MP8030 has the following physical dimensions:

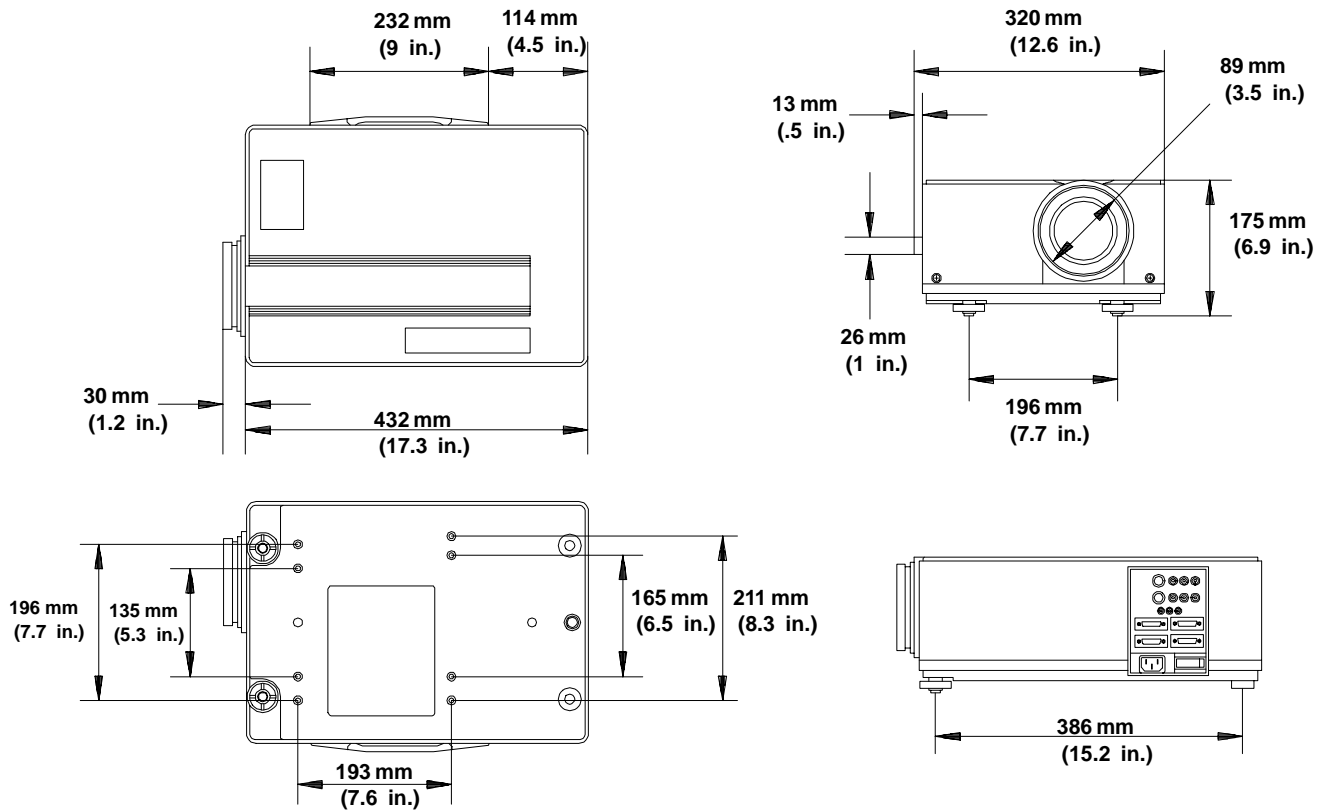

9-4. Computer Video (RGB) Input Signal

Computer/ Signal Source	Resolution H X V	fH (kHz)	fV (Hz)	Sync Signal	Interlaced	Note
15 kHz RGB (NTSC)	—	15.7	60	H, V composite	yes	
VGA-1 (IBM compatible)	640 x 350	31.5	70	H, V separate H : Positive V : Negative	no	
VGA-2 (IBM compatible)	640 x 400	31.5	70	H, V separate H : Negative V : Positive	no	
VGA-3 (IBM compatible)	640 x 480	31.5	60	H, V separate H : Negative V : Negative	no	
Macintosh 13 in. mode (Apple)	640 x 480	35.0	66.7	H, V separate H, V composite	no	
VESA 72 Hz standards	640 x 480	37.9	72	H, V separate H : Negative V : Negative	no	
SVGA (VESA 60 Hz)	800 x 600	37.9	60	H, V separate H : Positive V : Positive	no	640 x 480 compress ed
SVGA (VESA 72 Hz)	800 x 600	48.1	72	H, V separate H : Positive V : Positive	no	640 x 480 compress ed

9-5. Computer Video (RGB) Input Terminal

The following illustration (Figure 9-1) shows the terminal connections for the D-sub 15 pin HD connector. Refer to the table below for a description of the wire to pin connections.

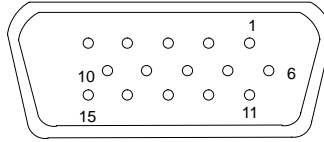

Figure 9-1. D-sub 15 pin HD Connector

Pin #	Description	Pin #	Description
1	Video signal (red)	9	No Connection
2	Video signal (green)	10	Ground
3	Video signal (blue)	11	Ground
4	No Connection	12	No Connection
5	No Connection	13	Horizontal/composite sync signal
6	Ground (red)	14	Vertical sync signal
7	Ground (green)	15	No Connection
8	Ground (blue)		

9-6. S-Video Input Signal Terminal

The following illustration (Figure 9-2) identifies the terminal connections for the Mini DIN4-pin.

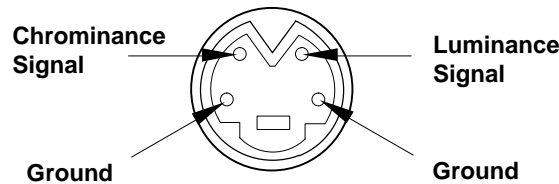

Figure 9-2. S-Video Input (Mini DIN4-pin)

Video input signal terminals are detected by the MP8030 in the following order of priority:

- 1) S-video input terminal
- 2) RCA jack input terminal

9-7. RS-232 Cable (Mouse Control)

The computer to projector terminal connection for the D-sub 9 pin HD connector (Figure 9-3), is shown below.

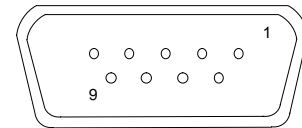
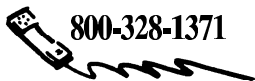

Figure 9-3. RS-232 Connector

Computer		Projector	
CD	1	1	NC
RD	2	2	RD
TD	3	3	TD
DTR	4	4	NC
GND	5	5	GND
DSR	6	6	NC
RTS	7	7	NC
CTS	8	8	CTS
RI	9	9	NC

We're easy to reach



3M Austin Center
Building A145-5N-01
6801 River Place Blvd.
Austin, TX 78726-9000

3M Canada
P.O. Box 5757
London, Ontario
N6A 4T1



**<http://www.mmm.com/office>
e-mail: presentations@mmm.com**

3M Mexico, S.A. de C.V.
Apartado Postal 14-139
Mexico, D.F. 07000
Mexico

3M Europe
Boulevard de l'Oise
95006 Cergy Pontoise Cedex
France



Let us help you make the most of your next presentation. We offer everything from presentation supplies to tips for better meetings. And we're the only transparency manufacturer that offers a recycling program for your used transparencies. For late-breaking news, handy references and free product samples, call us toll-free in the continental United States and Canada, 7:30 a.m. to 5:30 p.m. (CST). Or visit our Internet Web site.

Printed in U.S.A. © 3M 1996
78-6970-7246-6